

U-0
(Vol. 1 of 2)

historic structure report
architectural data section
volume 1
june 1985

MARTIN VAN BUREN

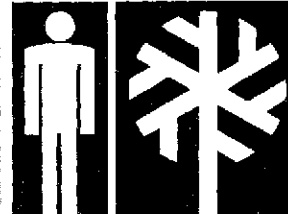

NATIONAL HISTORIC SITE / NEW YORK

ON MICROFILM

PLEASE RETURN TO:
TECHNICAL INFORMATION CENTER
DENVER SERVICE CENTER
NATIONAL PARK SERVICE

B&W Scans
4-14-2003

HISTORIC STRUCTURE REPORT

Architectural Data Section

LINDENWALD

MARTIN VAN BUREN NATIONAL HISTORIC SITE

Kinderhook, New York

by
William W. Howell

U.S. Department of the Interior / National Park Service

CONTENTS

Acknowledgments	viii
Introduction	1
I. Administrative Data	3
II. Brief Description of Lindenwald	5
A. Background	5
B. Summary of Available Data	6
C. Status of Other Research	6
III. History of Physical Changes	7
A. 1797	7
1. Exterior	7
2. Interior	9
3. The Wings	12
B. 1805-1810	15
C. 1840-1841	17
D. 1849-1850	19
E. 1863-1874	27
F. 1874-1917	27
G. 1917-1957	29
IV. Architectural Description	31
A. Exterior	31
1. Dimensions and Orientation	31
2. Number and Height of Stories	31
3. Foundations	31
4. Wall Construction and Surface	32
5. Roof Construction and Surface	34
6. Porches and Stoops	43
7. Bulkhead	44
8. Window Wells	46
9. Coal Chute	47
10. Windows and Shutters	47
a. Vertical Sliding Sash	47
b. Casements	49
c. Fixed Windows	50
d. Bricked-in Windows	51
e. Picture Windows	52
f. Window Changed to Door	52
g. Recommendations	52
11. Doors and Doorways	52
12. Chimneys and Flashing	53
13. Cornices, Gutters, and Leaders	57
14. Skylight	58
15. Walks, Drives, and Related Site Features	59

B.	Interior	60
1.	Basement	60
a.	Room 001 - Furnace	60
b.	Room 002 - Storage	62
c.	Room 002A - Storage	64
d.	Room 003 - Hall	65
e.	Room 003A - Vegetable Bin	68
f.	Room 004 - Wine Storage	69
g.	Room 005 - Servants' Dining and Stair	71
h.	Room 006 - Kitchen	74
4i.	Room 007 - Laundry	77
j.	Room 008 - Stair Hall	81
k.	Room 009 - Basement Entry	83
l.	Room 010 - Transitional Space	85
m.	Room 011 - Chamber	87
n.	Room 012 - Back Hall	89
o.	Room 013 - Vaulted Tunnel	92
p.	Room 014 - Privy Pit	93
q.	Room 015 - Coal Storage	94
2.	First Floor	96
a.	Room 101 - Bedroom	96
b.	Room 102 - Bathroom	99
c.	Room 103 - Closet	100
d.	Room 104 - Parlor	102
e.	Room 105 - Banquet Hall	105
f.	Room 106 - Parlor	110
g.	Room 107 - Storage	115
h.	Room 108 - Closet/Stair/Bath	116
i.	Room 109 - Library/Den	118
j.	Room 110 - Stair	123
k.	Room 111 - Library	124
l.	Room 112 - Bedroom	127
m.	Room 113 - Tower Stair	130
n.	Rooms 114/115/116 - Bathroom/Water Closet/Access	131
o.	Room 117 - Hall	135
p.	Room 118 - Nursery	137
q.	Room 119 - Hall	140
r.	Room 120 - Hall	142
s.	Room 121 - Privy	143
t.	Room 122 - Storage	144
u.	Room 123 - Chamber	145
3.	Second Floor	146
a.	Room 201-Guest Chamber	146
b.	Rooms 202/203/204 - Closet/Bathroom/Closet	149
c.	Room 205 - Guest Chamber	151
d.	Rooms 206/207/208/209 - Stair Hall/Game Room/Entry/Two Chambers	155
e.	Room 210 - Chamber	163
f.	Room 211 - Hall	168
g.	Room 212 - Tower Stair	170
h.	Room 213 - 1850 Attic	171

4.	Third Floor	172
a.	General	172
b.	Room 301 - Attic	173
c.	Room 302 - Hall	175
d.	Room 303 - Servant's Chamber	179
e.	Room 304 - Servant's Chamber	180
f.	Room 305 - Servant's Chamber	181
g.	Room 306 - Attic	182
h.	Room 307 - Hall	183
i.	Room 308 - Tower Stair	184
j.	Rooms 309/310/311/312/313 - Attic	186
5.	Fourth Floor - Tower Stair	186
6.	Fifth Floor - Belvedere	188
C.	Utilities and Structure	190
1.	Structural System	190
a.	Main House Roof	190
b.	Upjohn Addition Roof	191
c.	Floor Framing	192
d.	Third Floor	192
e.	Second Floor	194
f.	First Floor	198
g.	Basement	200
h.	Tower Stairs	202
i.	Main House Stairs	202
j.	Exterior	203
k.	Recommendations	203
l.	Conclusion	204
2.	Heating System	204
a.	Fireplaces	204
	(1) Basement	205
	(2) First Floor	206
b.	The Cook Stove	210
c.	Recommendations	224
3.	Plumbing	225
a.	Kitchen - Room 006	226
b.	Laundry Room	227
c.	Bathroom	227
	(1) Water Closet	228
	(2) Bathtub	230
	(3) Sink	233
d.	Conclusion	234
4.	Electrical System	246
5.	Communications	261
a.	Identification of the Components of the System	262
	(1) Bells	262
	(2) Bell Cranks	263
	(3) Pivots	263
	(4) Bell Wire	264
	(5) Staples	264
b.	Functioning of the System	264
	(1) First Floor	264
	(2) Second Floor	265
	(3) Basement	267
c.	Recommendations	267

6.	Lightning, Fire, and Intrusion Protection	267
a.	Lightning Rods	267
b.	Fire Detection System	269
c.	Fire Suppression System	270
d.	Intrusion Protection System	271
V.	Statement of Restoration Philosophy	275
VI.	Analytical Data	277
A.	X-ray Investigation	277
1.	Room 105	277
2.	Room 106	277
3.	Room 206/207	278
4.	Room 207	278
5.	Room 208	278
6.	Room 209	278
B.	Moldings Study	298
C.	Finishes Study	299
1.	Paint	311
a.	Procedure	311
b.	Interior Rooms	312
c.	Exterior	325
d.	Conclusions	326
2.	Wallpaper Study	328
a.	Procedure	328
b.	Room Descriptions	329
D.	Hardware Study	337
1.	Locks	337
a.	Stock Locks	337
b.	Sheet-Iron Rim Locks	338
c.	Cast-Iron Rim Locks	339
d.	Sheet-Iron (or Steel) Mortise Locks	341
e.	Cast-Iron Mortise Locks	343
2.	Hinges	344
3.	Window Hardware	345
4.	Fasteners	346
a.	Nails	346
b.	Screws	355
E.	Door and Window Schedules	357
F.	Mortar and Plaster Studies	367
1.	Statistical Analysis	367
a.	Data	367
b.	Sampling Method	367
c.	Cluster Analysis	369
d.	"Unstructured" Clustering	369
e.	Structured Clusters	369
f.	Qualitative Variables	371
g.	Conclusion of Statistical Analysis	371
2.	Analytical Results	372
3.	Conclusion	382
	Bibliography	384

ACKNOWLEDGMENTS

The preparation of this report has been a long and arduous process for all involved. The labors have been rewarded by many who have provided encouragement along the way. In addition, many people have assisted. The team initially assigned to this project consisted of historical architects Marsha L. Fader of the North Atlantic Historic Preservation Center and Jean C. Parker of the Denver Service Center and myself as project historical architect. The project began in April 1978 and encountered its first setback in March 1979 with the resignation of Ms. Parker after preliminary work on the molding profile study and after significant contributions to the task directive and the reconstruction of cornices. Ms. Fader completed drafts of the first- and second-floor room descriptions, a paint analysis, a molding profile study, an X-ray investigation, and portions of the exterior description before her resignation in spring 1980.

In fall 1979 Andrea Gilmore, architectural conservator of the North Atlantic Historic Preservation Center, was enlisted to provide research assistance on wallpapers, heating systems, plumbing, and bell pulls. Ms. Gilmore has continued as project liaison with the North Atlantic Historic Preservation Center and has been especially helpful in the analysis of supplementary paint samples. In fall 1980 historical architects S. Elizabeth Sasser and John B. Marsh, of the Denver Service Center, joined the team and immediately began work on various items of fabric investigation, elevation drawings, and construction documents. Ms. Sasser should receive credit for the reconstruction drawings for the front porch and for some of the details of the roof restoration, and Mr. Marsh should receive credit for the tower deck and balusters, the dormer sills and scrolls, and two pairs of arched windows.

The entire team wishes to express its appreciation to Superintendent Bruce W. Stewart and the staff of Martin Van Buren National Historic Site for their outstanding assistance, cooperation, encouragement, and patience. Chief of interpretation William N. Jackson, curator Mary Smith, and chief of maintenance Richard A. Lusardi are to be commended for their professionalism, their enthusiasm, and their love of Lindenwald.

Project funds were provided by the National Park Service, Denver Service Center. The Mid-Atlantic/North Atlantic Team, Denver Service Center, provided administrative and technical support. This project was especially enhanced by the support of Gerry Patten, assistant manager; Nan Rickey, chief, Branch of Cultural Resources; Vance Kaminski, Gary Higgins, and Harold LaFleur, all senior historical architects (at various times); Kathleen Fiero, archeologist; and Evelyn Steinman, editorial clerk. The completion of this report would not have been possible without their contributions.

William W. Howell
Denver, Colorado
May 26, 1981

INTRODUCTION

This report is organized and presented in increasing levels of detail. Conclusions and broad statements of findings are presented first for convenient reference by managers and interpreters. A discussion of conditions, evidence, and recommendations for people directly involved in the construction work is contained in later sections of the report. The report, of course, was prepared in the reverse order. As is proper for all investigative activities, we proceeded from data gathering to analysis, to synthesis and correlation of the data, and finally to statements of hypotheses, findings, and conclusions.

Section I of this report contains the administrative data concerning the Martin Van Buren home. Section II provides a brief description of the site and structure, including previous planning and research. Section III describes the physical evolution of the home and is coordinated with the evolution drawings. Section IV is the body of the report, containing detailed descriptions of the exterior and interior of the home. These descriptions identify the specific physical evidence that has been found to document the alterations made; they also contain preservation and restoration recommendations. Most of this section is arranged by location, but systems that occur in several locations and are best understood as systems are discussed in a separate section as well as in connection with the locations where their manifestations occur. Section V presents the philosophy that guided the recommendations and a summary of the recommendations. Section VI contains the results of specific types of data and fabric analysis that were performed. Supporting data can be found in the appendixes.

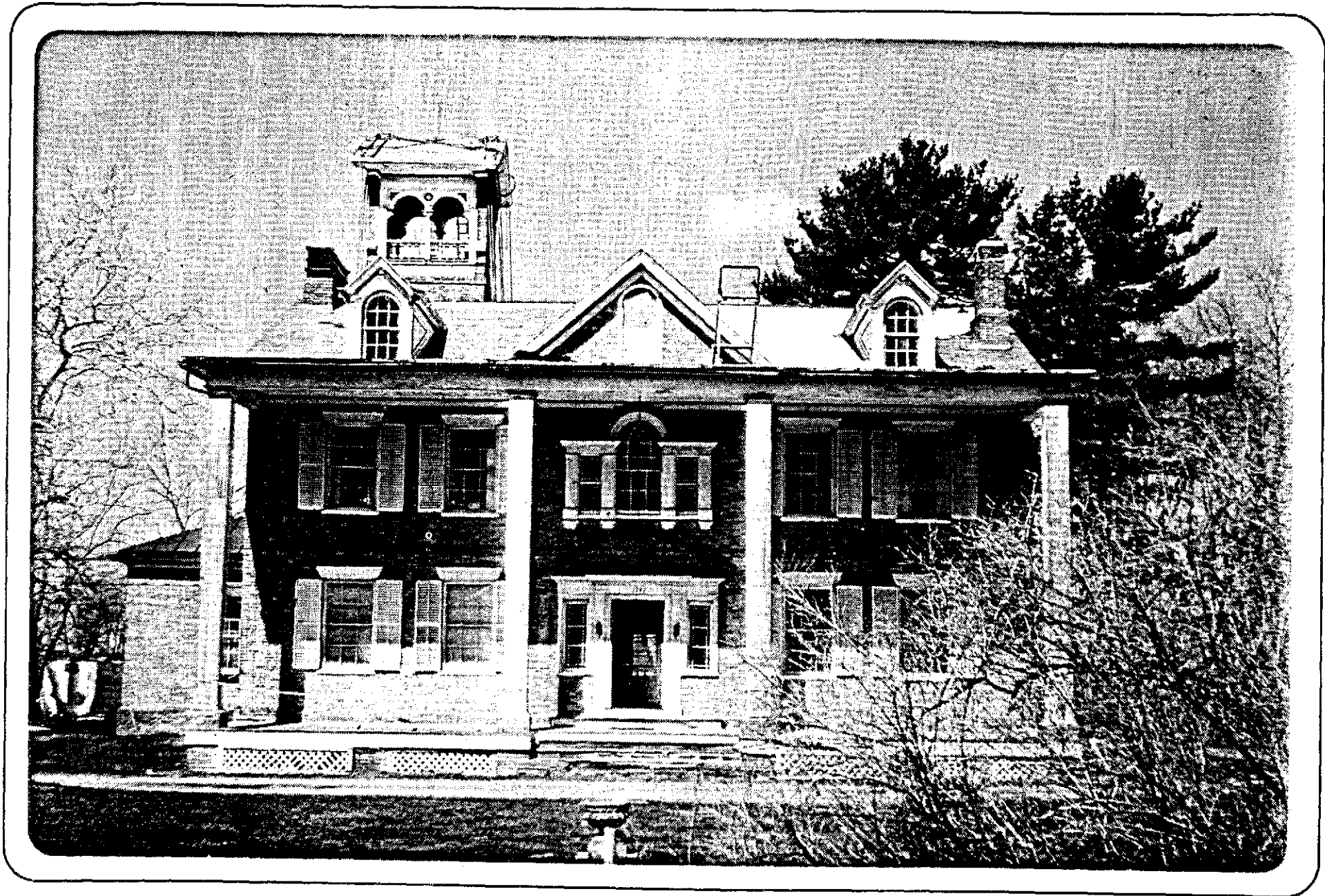

Lindenwald April 1978

I. Administrative Data

A. Name and Number of Structure

The Martin Van Buren home, Lindenwald, was historically and culturally significant from 1797 to 1862. Its prime period of significance was 1839-1862, when it served as the retirement home of the eighth president of the United States. The mansion is of the first order of significance, and it is HS 1 on the List of Classified Structures at Martin Van Buren National Historic Site.

B. Proposed Use of Structure

The Martin Van Buren home is being restored and rehabilitated to the period 1850-1862, after the Richard Upjohn alterations. It will serve the visiting public as a restored historic house commemorating Martin Van Buren's political career and depicting his life on the estate. Existing original structural features from this period will be preserved and restored. All structural work will be based on the findings of the historical data, the architectural data, and the archeological investigation sections of the historic structure report. Adequate protection against fire and illegal entry will be installed with minimal damage to historic fabric and with the least possible visible intrusion. To ensure visitor and structural safety, only guided tours of the mansion will be permitted. Tours will be limited to 15 persons, and there will be no more than two tours underway at any one time.

C. Justification for Such Use

The structure is on the List of Classified Structures and the National Register of Historic Places. Martin Van Buren National Historic Site was established as a unit of the national park system by Public Law 93-486 on October 26, 1974.

D. Cooperative Agreement

No cooperative agreement exists or will be required to operate the mansion. The park has recently signed a cooperative agreement with the Friends of Lindenwald, a nonprofit organization "interested in the preservation and interpretation of Lindenwald and in furthering the study and appreciation of Van Buren's important role in American history."

E. Brief Description of Proposed Construction Activity

Rehabilitation and restoration of the mansion proceeded on a large scale in 1980 and 1981. In 1980 the work consisted of rehabilitation and restoration of major exterior portions of the mansion and some interior work. In late summer 1981 the project was closed down because of problems with the historic structure report (see section II.C.) and the withdrawal of congressional funding. In the fall of that year, with the bicentennial of Van Buren's birth approaching, the park superintendent decided to have the park's maintenance division restore several first-floor rooms. This project was completed in September 1982.

For fiscal year 1984 the park received funds to continue the restoration work on the mansion. The first project undertaken was the reconstruction of the Upjohn front porch; begun in late October 1983, the work was completed in mid-May 1984.

An A/E firm is currently designing the new mechanical and safety systems, which will be installed in the mansion as part of the overall restoration project.

II. Brief Description of Lindenwald

A. Background

Lindenwald, the home of Martin Van Buren, eighth president of the United States, is the primary structure of the Martin Van Buren National Historic Site.* It is on the east side of the upper Hudson Valley in the town of Kinderhook, New York. Kinderhook is in Columbia County, 21 miles southeast of Albany. The UTM references for the house on the U.S. Geological Survey mapping system are Zone 18 - Easting 606460 - Northing 4691700.

The 12.8-acre national historic site is on a slight bluff above Kinderhook Creek.** The terrain is flat and uniform, and Lindenwald is roughly in its center. The home is surrounded on the east by a large formal lawn and plantings, on the south by a lawn and trees, on the west by farmland under active cultivation, and on the north by a small lawn and grove of trees. Access to Lindenwald is by a semicircular driveway from U.S. 9H and the Old Post Road. Originally, access was only from the Old Post Road.

Architecturally, Lindenwald is composed of two distinct parts--the original two-and-one-half-story brick Georgian house built by Peter Van Ness ca. 1797; and the one-story plus tower addition designed by Richard Upjohn and built in 1849-50 by Martin Van Buren's son, Smith Thompson Van Buren. The two parts of the house were made to appear more compatible by architectural elements added to the exterior of the original house by Richard Upjohn. These additions included an eclectic Italianate/Gothic front porch, dormers flanked by scrolls in the east roof, east and west facade gables, an oriel window, and a bold modillion cornice. Similar elements (moldings, doors, and windows) were used to blend the two parts of the interior of the house.

Martin Van Buren purchased Lindenwald from William Paulding, Jr., in 1839 and resided there from 1841, when he was defeated for the presidency, until his death in 1862.*** The house will be restored to ca. 1862 to preserve and present all of the changes Van Buren made to the house in the course of his life there.

*Other structures at the site include the south gatehouse built ca. 1840-50 and a modern maintenance garage. During Van Buren's residency other outbuildings on the site included a north gatehouse and a farm office (foundations of which remain), as well as a stable, a carriage house, a well house, a sheep shed, a hay barn with press, and several other barns--none of which are standing. In addition, there was a farmhouse that may be part of the present farmhouse to the southwest of Lindenwald. See Stokinger 1981, 80.

**The park is currently in the process of acquiring an additional 6.8 acres and is purchasing easements on an additional 15 acres. The park is also negotiating for an additional 1.6 acres from the town and state.

***In this report the years of Van Buren's residency at Lindenwald will be referred to as the historic period.

B. Summary of Available Data

The following NPS documents were available to the authors:

Planning Documents

Master Plan (1970)
Statement for Management (1978)
Task Directive (1981)
Resources Management Plan (1981)
Development Concept Plan (1984)

Natural History, Cultural History, and Recreational Information

"Lindenwald," The President Martin Van Buren Homestead, near
Kinderhook, New York, by Melvin Weig (1936)
Feasibility Study (1966)
Scope of Collections Statement (1978)
Addendum to Historic Structures Report* (1980)
Lorraine M. Poll Report (1981)
Margaret Coffin Report (1981)
Historic Resource Study (1982)
Historic Grounds Report (two vols., 1982)
Archeological Survey of the Proposed Utility Line Servicing the
Mansion and South Gate House (1982)
Historic Structure Report, Archeological Data Section (1983)
Cultural Resources Remote Sensing and its Limitations: A Test at
Martin Van Buren NHS (1983)
Interim Interpretive Prospectus (n.d.)
Historic and Restoration Photographs
Museum Catalog Cards

The background data most essential for the completion of this report is contained in the historic resource study, the addenda to it, the archeological data section of the historic structure report, and the historic grounds report. No effort will be made to summarize that information here because it has been cited as appropriate in the text.

C. Status of Other Research

The historic resource study was originally programmed and intended to be the historical data section of the historic structure report. During review of that document it was determined that its scope was too broad for the intended use, and its title was changed to a historic resource study. The information from the resource study that is specific to the structure, as well as other documentation, has been included in this historic structure report.

Two additional planning documents are currently being prepared at the park level: the historic furnishings plan and the interpretive prospectus.

*Prepared after the initial review of the historic resource study, when the study was still titled historic structures report. See section II.C.

III. History of Physical Changes

The evolution of Lindenwald can be divided into roughly six periods--ca. 1797, the building of the original house by Peter Van Ness; ca. 1805-1810, the acquisition and alteration to the house by William Van Ness; ca. 1840, the alterations made to the house by Martin Van Buren when he purchased the property; ca. 1849-1850, the alterations and additions to the house designed by Richard Upjohn for Van Buren's son; ca. 1890, the abandonment of the basement rooms and the alterations made to the first-floor rooms to accommodate the functions that had been housed in the basement; and ca. 1974, the acquisition of Lindenwald by the National Park Service. Floor plans and elevations for each phase in the evolution of Lindenwald are illustrated by drawings. Documentation for these alterations is presented in detail in the individual room descriptions.*

A. 1797

1. Exterior

The original portion of Lindenwald was built ca. 1797 by Peter Van Ness. A silver plate on the knocker of the front door bears the date 1797, and it, along with the door on which it hangs, are discussed by Van Buren "as interesting memorials of my last interview with its [Lindenwald's] original owner" (Fitzpatrick 1920). Extant physical evidence, specifically the nails, also supports this date of construction.

The Georgian-style house that Peter Van Ness built was five bays wide and four bays deep.** It was two-and-one-half stories, with a full basement. The house had a gable roof, with the ridge running in a north-south direction. The roof was covered with wood shingles. The gable ends of the roof each contained two chimneys in approximately the centers of the sloping sides of the gables. The foundation walls were built of fieldstone, parged to look like ashlar. They were painted a rust brown color. The walls of the house were of brick construction, painted red with white penciled joints. A stucco patch above windows 103 and 104, part of the original construction of the front door, is painted red, indicating that the house was probably painted as soon as it was built.

The fenestration of the ca. 1797 house is symmetrical but is dominated by the Venetian window in the center of the second story of the east elevation. Window openings were capped with brick flat arches; the central portion of the Venetian window had a semicircular arched brick opening. The sash was twelve-over-twelve, vertical sliding sash.

*As with any historic structure, minor alterations were made to Lindenwald on a continual basis that cannot be precisely dated; hence the circa dates.

**The west elevation of the house is only three bays wide. The difference in the number of bays only reflects a difference in the number of windows. The lengths of the east and west elevations are the same.

The central portion of the Venetian window contained a twelve-light vertical sliding lower sash and a fixed semicircular "Gothick" upper sash.* The sidelights contained four-over-four sliding sash (Peterson 1971). The "Gothick" sash is the only first- or second-floor window that retains its 1797 muntins and glass.

Two six-over-six windows were in each of the gable ends of the house. Exceptions to the symmetrical spacing of the windows are found in the central windows on the first and second stories of the gable ends. These windows were placed slightly toward the back of the house because the front rooms were larger than the corresponding back rooms. The spacing of the basement windows was also asymmetrical. There were six casement windows, probably with six lights each, in the east foundation wall. Two other casement windows appear to have been located in the north portion of the west wall. Evidence of a ca. 1797 basement opening at the west end of the south wall cannot be identified as the head of a door or a window.

The main entrance in the original house was in the center of the east elevation, where it remains. It consisted of a Dutch door framed by pilasters and an entablature. It was flanked by four-over-six sidelights. Brick footings for the original stoop were found during archeological excavations during the summer of 1979. No evidence of a ca. 1797 porch superstructure has been found.

Four other ca. 1797 exterior doors were in the west elevation of the house. The filled-in arched opening of door 120 suggests that originally it was a larger exterior door. The filled, arched opening in the west wall of room 101 (D105) indicates that it served a similar purpose. Since the brickwork surrounding these openings is not cut, they are considered to be original openings.

There was probably a third door in the west wall of room 105. The door currently in this location dates to ca. 1840 and has concealed any evidence of an earlier door. No evidence remains of the doors, frames, or stops that were originally used in these locations.

A fourth door was located in the west wall of the foundation, approximately 2' 4" south of the present door in this wall. The location is marked by the south jamb and lintel embedded in the later masonry.

All evidence of the cornices, gutters, and downspouts for the ca. 1797 house has been destroyed. Similar houses usually had box cornices with integral wooden gutters and wooden downspouts (if there were downspouts). The cornices were composed of classical moldings, and the overall projection from the vertical wall was seldom more than 1-1/2 feet.

* "Gothick" is a Georgian period term for a style based on the Gothic period.

2. Interior

The original plan for the basement consisted of five rooms: a central hall extending the full length of the building, with two rooms arranged symmetrically on both its north and south sides. A steep stair led from the southwest corner of the central hall (room 003) to the first-floor central hall (room 105).

The basement rooms in the original house appear to have been used for storage. The finishes in these rooms reflect this use: Woodwork consisted of board-and-batten doors set in heavy wood frames; walls were whitewashed. No evidence of the ca. 1797 kitchen has been found in the basement.

The ca. 1797 plan for the first floor was the same as the original plan for the basement. The north and south pairs of rooms were separated by closets running the full widths of the rooms. These rooms were roughly square in design except for room 109, which was L-shaped. The rooms on the west (back) side of the house were slightly smaller than those on the east (front) side.

A U-shaped stairway was at the west end of the central hall. It ran along the south wall, across the west wall, and then up the north wall to the second floor hallway. The stairs may have been separated at this time from the east end of the central hall by a partition wall with a large central opening.

Access to all first floor rooms, except the closets, was from the central hall. In rooms 101, 104, and 106 the doors were placed in the center of the wall of the room that adjoined the central hall. In room 109 the door was at the west end of the north wall, under the stairs. The center of this wall was blocked by the stairs. Passage between the pairs of north and south rooms was also possible through the closet areas.

Located at the gable end of each of the first-floor rooms was a fireplace, flanked on both sides by a window. Rooms 101 and 109 had single doors in roughly the center of their west walls; rooms 104 and 106 had a pair of windows in their east walls.

The original decorative finishes of the first-floor rooms varied according to their use. Rooms 104 and 106, the front parlors, and room 105, the main hall, were more elaborately finished than rooms 101 and 109, which were probably used as a guest bedroom and family dining room respectively. In rooms 104, 105, and 106 the windows and doors were trimmed with casings consisting of an ogee and bead and an applied bead with a cavetto and bead forming its inner edge. In room 105 the flat area of the door casing, between the ogee and bead and the applied bead, was filled with fluting. In all these rooms the door casings were surmounted by an entablature based on a vernacular interpretation of the Doric order. The doors (102, 107, and 136) had six raised panels with applied moldings hung with five-knuckle ten-hole cast-iron butt hinges. They probably had sheet-iron rim locks, but they have been replaced by later locks. All the windows had folding, paneled shutters.

The baseboards in these rooms consisted of an upper board with alternating flat and fluted areas and a plain lower board. The top of the baseboard was composed of a bead and cavetto. All three rooms had similar but not identical molded plaster cornices. The original fireplace surrounds in rooms 104 and 106 have been removed. It is presumed they were similar to the ones in rooms 101 and 109 that are still in place.

Atypical of all the other woodwork in the ca. 1797 house is the ogee arch that frames the alcove in the west wall of room 106 (see inspection photograph [IP] 031, NO23-37, in appendix B). The arch rises from simple pilasters, decorated with a shallow tracery.

The absence of any early paint on the plaster walls in rooms 104 and 106 indicates that the ca. 1797 finish for these surfaces was wallpaper. In room 106 a sample of the original wallpaper (WP004) was found behind the pier mirror on the east wall. It is a handmade paper with a blue ground. The design consists of clusters of red flowers and green leaves highlighted with black lines. The woodwork in room 106 was painted pale green. No evidence has been found of the ca. 1797 wallpaper that hung in room 104. The woodwork in this room was originally painted light yellow except for the baseboards, which were painted light brown. In room 105 the plaster walls were finished with decorative freehand wall paintings. The paintings were composed as borders around the doors, windows, chair rail, baseboard, and cornice and consisted of festoons of flowers and fruit. They were painted directly onto the brown-coated plaster walls. The principal colors of the wall paintings were green, black, white, and vermillion. The woodwork in room 105 was originally painted light yellow.

The ca. 1797 decorative finishes in rooms 101 and 109 were similar to, but more modest than, those in rooms 104, 105, and 106. The door and window casings were the same in all first-floor rooms except that the door casings in rooms 101 and 109 were not surmounted with entablatures. The baseboards in these rooms were less ornate, consisting of plain boards with an ovolo molding at the upper edge. The mantelpieces were of wood. Their design was a molded architrave, mitered at the corners. Above the architrave was a plain frieze that curved upward and inward to meet a simple cornice with a dentil course. The original doors and their hardware and the window shutters were the same in all the first-floor rooms.

The plaster walls in room 101 are currently unpainted, indicating that originally they were covered with wallpaper. No evidence of this wallpaper has been found. The woodwork in this room was painted light yellow, except for the baseboards, which were painted light brown. The plaster walls in room 109 were covered with freehand paintings ca. 1797. Borders surrounded the door and window casings, chair rail, baseboard, and cornices; the area above the dado was filled with curvilinear foliate motifs. The principal colors of the wall paintings were black, white, and vermillion. The original color of the woodwork in room 109 was pale green.

Unlike the basement and first floor, the plan for the second-floor rooms was not symmetrical. The central hall occupied only the western half of the central portion of this floor, the eastern portion formed part of a large southeast corner room. The stairs from the first floor were along the west and north walls of room 206; the attic stairs were through door 210, also in the north wall of room 206.

Access to the second-floor rooms, except to room 205, was from room 206. Room 205 was entered from the large southeast room 207/208/209. The placement of the access doors in room 206 was dictated largely by the locations of the first-floor and the attic stairs. The door into room 201 was in roughly the center of the north wall; the door into room 207/208/209 was in the center of the east wall (all evidence of this door has been destroyed by the later, larger arched opening in this location); the door into room 210 was at the east end of the south wall. Passage was also possible between rooms 207/208/209 and 210 through door 216.

A fireplace, flanked by single windows on both sides, was at the gable end of each of the major second-floor rooms. Rooms 201 and 210 had a single window in the center of their west walls; rooms 205 and 207/208/209 had a pair of symmetrically placed windows in their east walls. The southeast room also had a Venetian window at the north end of the east wall.

The decorative finishes in the second-floor rooms, as on the first floor, reflect their uses. Room 206, the hall, and room 207/208/209, probably a ballroom, were public rooms and therefore more ornately finished. Rooms 201 and 210 were bedrooms. Room 205 may have been another bedroom; however, since the only access to this room was from room 207/208/209, it may have been used as an ancillary room to the ballroom.

The window and door casings of the second-floor rooms in the ca. 1797 house consisted of a double architrave with a cavetto molding. The windows had hinged interior shutters. The doors were six-panel doors hung with HL hinges. The baseboards in rooms 201, 205, 206, and 210 were plain with an ovolo molding at the upper edge. The baseboards in room 207/208/209 were also plain with a molded upper edge comprised of a cyma recta and bead. The second-floor mantelpieces were similar but not identical. They consisted of a molded architrave surrounding an off-center opening, a plain frieze with curved outer ends, and an overhanging cornice.

The plaster walls in rooms 206 and 207/208/209 were originally finished with freehand wall paintings. In room 206, the chair rail, the door casings, and the cornices had painted borders of vinelike foliage and flowers in black, white, vermilion, and green--similar but not identical to the wall paintings in room 105. In room 207/208/209 floral festoons separated by vertical tassels encircled the room below the cornice. The principal colors of these paintings were white, vermilion, and black. The wall paintings in room 207/208/209 were different from all the other ca. 1797 wall paintings in that they were painted over a layer of green paint and were located only below the cornice rather than

around all the major architectural elements in the room. The woodwork in rooms 206 and 207/208/209 was painted light yellow.

The plaster walls in rooms 201, 205, and 210 have no early paint, so it is assumed that they were originally wallpapered; however, no evidence of this wallpaper has been found. The woodwork in rooms 201 and 205 was painted light yellow. In room 210, the woodwork was painted light blue.

The third floor of the house served as an attic, with one large unfinished space and two windows in each of its gable ends.

3. The Wings

The question of whether there were wings at the rear of the house built by Peter Van Ness cannot be answered conclusively. Two contemporary accounts refer to wings at the rear of the house. Gideon Welles wrote in his private journal after a visit to Lindenwald in October 1843: "There are two wings to the house placed to the rear" (Welles Papers). On March 5, 1849, Van Buren wrote to Francis P. Blair saying: "to accomplish the object [building the Upjohn addition] satisfactorily gradual changes will become necessary--such as the taking down of the present stable wings and erecting towers in their places" (Blair Papers). The wings are mentioned in both references in the plural.

There are five known graphic representations of Lindenwald that apparently show the house prior to 1850. The first one and probably the oldest is a sketch that appears on a survey map of the property (see historical photograph [HP] 1 in appendix A; a complete set of the historic photographs referenced in this report is included in that appendix). A comparison of this map to written property descriptions in deeds and survey field notes strongly suggests that the survey map was drawn before Van Buren acquired the first additional parcel of land on July 25, 1843, because it does not include that parcel or any of the later parcels. The map is a close, but not perfect, fit to both the 1834 survey field notes and the 1839 deed from the Pauldings to Van Buren. It shows several outbuildings behind (north and west of) Lindenwald, but does not show wings or gatehouses. The map also designates certain areas as "garden," "Rye field," "North Orchard," and "South Orchard."

The remaining four images all relate to one another, but they may be discussed in groups of two. The main difference between the images is the presence or absence of human figures in the foreground. The images with figures are more clearly delineated than those without. All the images are in a print medium, probably engraved, but the photographic and xerographic reproductions available to the author do not allow a definitive identification of the medium.

Copies of two similar prints, respectively captioned "Residence of Martin Van Buren" (HP2) and "Lindenwald, Van Buren's Home," are in the collection of Martin Van Buren National Historic Site. They are identical images (clearly delineated and with figures) except that the former view is more inclusive horizontally and less inclusive vertically than the latter and the former is contained within a rectangular

border and the latter fades out irregularly into the blank page. A copy of the former print was found at the Boston Athenaeum with the following notation: "Acquired at the A. S. Mason sale, November 10, 1905." The format of the latter print suggests that it was originally published in a book, but there is no information about the book. According to Nan Rickey, Denver Service Center, the style of clothing on the figures indicates a date in the range ca. 1854 to ca. 1860.

The two prints without figures are captioned respectively, "Home at Kinderhook, New York of Martin Van Buren" and "From a print about 1847" (HP3). The former was published in Richardson (1909). The latter was found at Lindenwald, but there is no other information about its source. The approximate date of 1847 is consistent with NPS documentary evidence that the house had wings prior to the ca. 1849 addition and the photographic evidence that these prints do not represent the appearance of Lindenwald after the ca. 1849 addition.

All four prints exhibit the same discrepancies when compared with physical evidence still present on the building. The front door is shown as a single four-panel door. The historic Dutch door, six panels over two, survives. The Venetian window has only a small glazed area over the central opening, not the large arched area over all three openings shown in the prints. Physical evidence in the house indicates that there were two chimneys on the south gable end, not one as shown on the prints. The house has always been four bays deep, not three. The two central basement windows (003 and 004) are not shown on the prints. The presence of these errors on all four prints and other similarities--identical placement of trees and pattern of open and closed shutters--indicates that the prints probably all derived from one artist's visit to the house at one time. We have no information to indicate that the visit did not occur in 1847, and we cannot confirm the approximate 1847 date in the caption of the prints. Despite the errors, the resemblance of Lindenwald to the prints is strong enough to make the captions credible and to indicate that there is some truth in the way the wings are represented. The extent and nature of that truth is impossible to judge because we have no physical or photographic evidence with which to compare it. The credibility of these prints as representatives of Lindenwald is further enhanced by the apparent willingness of publishers to continue to use the image.

The foregoing discussion is presented so that readers may draw conclusions regarding the value of these prints as historical documents. Because we have other corroborated documents pertaining to the appearance of Lindenwald after 1850, it is only the appearance of the pre-1850 wings that is at issue. The author is skeptical about the validity of the representation of the wings. The information is certainly not sufficient to be used for the reconstruction of the wings. However, it is sufficient for conjectural reconstruction drawings, and only an idea of how the wings might have looked is needed. Since we know there were wings and these prints are the only graphic evidence of them, we must use them in our attempt to represent the appearance of Lindenwald prior to 1850.

The physical evidence of wings at the rear of the ca. 1797 portion of Lindenwald is similarly limited. Archeological investigations conducted during the summer of 1979 found no positive evidence of wings either at the rear of the present house or in the basement rooms of the Upjohn addition. In an excavation unit on the north side of the house, evidence of a builder's trench, running north-south, was found. The archeologists speculated that this trench may have been part of a wing wall; however, they qualify their statement as follows:

The only evidence of a wall was a row of large stones at the base of the trench. There were no bricks or evidence of wood in association with these stones. Also there was no evidence the trench had been disturbed once it was filled. Since either evidence of a wall or disturbance resulting from the dismantling of the wing would be expected, this feature and its function can only be established by further research in this area (NPS, Fiero 1983, 175-76).

Artifacts found beneath the basement floors during archeological investigations appear to have been associated with the building of the Upjohn addition, rather than earlier construction.

Evidence of the wings in the basement rooms is nearly as meager as that found under the basement floor. Only the whitewash on the east wall of room 012 and a small area of plaster and paint behind the casing above door 021 in room 006 suggest that the exterior walls of the original house may have been interior wing walls at one time. The whitewashed walls in room 012 may have been associated with a covered areaway.

Analysis of the artifacts in the fill of this builder's trench resulted in an assigned date of 1830-1850 for the fill. If the trench is the result of demolition of the north wing and it is larger than the builder's trench relating to the original construction of the wing, then there would be no evidence of the original trench. Whatever foundation wall (probably stone or brick) rested on the footing stones at the bottom of this trench may have been thoroughly demolished in order to reuse the materials in constructing the Upjohn addition. Why the footing stones were not also removed is unknown. The fact remains that they are there, and the only plausible explanation for their presence is that they supported a foundation wall. Further archeological investigations would reveal the relationship between this north-south builder's trench and the builder's trench associated with the Upjohn addition.

Detailed examination of the west exterior wall of the original house reveals little, if any, physical evidence of the wings. At the north corner of the ca. 1797 house the original brickwork is intact, indicating that a wing was never tied into this part of the house. The southwest corner of the ca. 1797 house has been removed and replaced by the tower. Furthermore, there is no evidence for the pockets for roof rafters or ceiling joists of wings in the brickwork on the west side of the house. The existing pockets were cut out of the brickwork when the Upjohn addition was built. Broken brick and paint layering on the brick indicate this date.

The paint layering sequence found on the west wall of the ca. 1797 house matched the paint layering found on all of the other exterior walls. Had wings been attached to the house, one would expect to find either different colored paints used on the portions of the walls that served as interior walls or an absence of exterior paint colors in the areas that were covered over by the wings.

Drawing conclusions about the wings at Lindenwald from the historical documentation and physical evidence presented above is indeed difficult. The evidence is scant and contains some contradictions. However, it appears that before 1849 there were wings on the west side of Lindenwald. Their date of construction and design is unknown. The absence of stone or brick foundation walls suggests that they were insubstantial structures and that they were not attached to the west wall of the ca. 1797 house. The three exterior doors in the west wall of the original house may have opened onto a long porch above a lower areaway. The porch may have been connected to the wings. This arrangement, although hypothetical, fits with the little evidence available. The function of the wings also remains unknown. Van Buren in his ca. 1841 correspondence, when he discusses the redecorating of the various rooms in the house, makes no mention of any rooms in the wings, suggesting that they were not part of the formal family living area. One wing, however, may have functioned as the "missing" kitchen.

B. 1805-1810

In 1805 Peter Van Ness willed to his son William Van Ness "the new brick house in which I now live" (Van Ness Will). William Van Ness made numerous alterations to the house his father had built less than ten years earlier. Van Buren, writing of these alterations in a letter dated April 9, 1849, said the following: "Old Mr. Van Ness built as fine a house here as any reasonable man could, . . . its taste of what was then . . . deemed the best. . . . William P. came and disfigured everthing his father had done" (Blair Papers).

On the exterior this disfigurement consisted of repainting. The new color scheme for the house was brick wall--white, wooden trim--cream, and sash--white. Paint samples suggest that the house may have been repainted these same colors by Van Ness ca. 1820-24 when the shutters were probably added and painted green. No other exterior alterations have been dated to his residency at Lindenwald.

In the basement no significant changes have been dated to William Van Ness. On the first floor the building of the partition separating the stairs from the eastern half of the central hall may have been done ca. 1810. As stated above, any physical evidence that could have been used to date this partition has been destroyed. However, the partitioning off of the rooms on the second floor by William Van Ness suggests that he may have made this room division as well.

Paint samples taken from the first-floor rooms indicate that the woodwork was repainted ca. 1810. A cream color was used in all rooms. In rooms 104, 105, and 106, a rust-colored graining was used on the doors and baseboards. Whether or not this redecorating included the hanging of new wallpaper is unknown. The only wallpaper that probably

dates to William Van Ness (WP005) was found under the pier mirror on the east wall of room 106 (the southeast parlor). It is a handmade paper with a foliate design. The shading of the paper was done with pinpoints. The layer of blue paint on top of the freehand wall paintings in room 105 may also date to ca. 1810.

The major alterations made by William Van Ness (ca. 1810) were to the second-floor rooms. Assigning this date to these alterations is based on the early cut nails used in the new woodwork, the similarities in paint sequences between the ca. 1797 and new woodwork, the presence of chair rails on the newly built partitions, and the predominant clay color of the plaster used for the new partition walls and patching.

Van Ness transformed the plan of the second floor by dividing room 207/208/209 into three smaller rooms. Room 207 became a small hall separated from room 206 by an arched opening that provided access to rooms 205, 208, and 209. Room 208 became a small bedroom, with access to rooms 205 and 209. Room 209 became another bedroom.

With the building of these partitions, numerous doors were filled in, moved, or newly installed. The doors most radically altered were those between room 207/208/209 and rooms 205, 206, and 210. Present doors 202, 203, and 204 were probably moved from ca. 1797 locations, and doors 201 and 217 were fabricated and installed in the partition on the north side of room 209. Paint layering on door 203 suggests that door 216 may have been reused in this location. Doors 201 and 217 were placed symmetrically across from doors 203 and 204. These doors and their casings are close but not exact reproductions of the ca. 1797 second-floor doors. They differ from these doors, however, in their molding profiles and the fact that they were hung with cast-iron butt hinges rather than HL hinges; door 202 was hung with cast-iron butt hinges as well.

As on the first floor, paint samples taken from the second-floor woodwork indicate that it was painted at least once between 1797 and 1840, probably ca. 1810. A cream-colored paint was used. A rust-colored graining was also found on the doors and baseboards in rooms 206 and 207. Samples taken from the plaster walls in rooms 206 and 207 indicate they were painted blue; the walls in rooms 208 and 209 were painted green. These walls were probably painted as soon as the alterations described above were completed so that the ca. 1810 partition walls were the same color as the original walls. No evidence was found of ca. 1810 wallpaper for rooms 201, 205, and 210; therefore, it is not possible to say whether William Van Ness completely redecorated these rooms.

No alterations to the third floor have been dated to ca. 1810.

In 1824 William Paulding purchased Lindenwald, and the house remained in his ownership until Van Buren acquired the property in 1839. Written documentation and physical evidence indicate that few, if any, significant alterations were made to the property during Paulding's residency. References made to the property by Van Buren when he purchased it indicate that the house and grounds had been victims of

years of neglect. In a letter to Levi Woodbury dated July 21, 1841, Van Buren said the following:

My success in improving my place has far exceeded my sanguine anticipations. The expenses, owing to the extent of the place, the size of the house, etc, and the length of time it has been substantially unoccupied, have, it is true been great (Blair Papers).

C. 1840-1841

Martin Van Buren purchased Lindenwald in 1839; however, it was not until after his defeat in the election of 1840 and his return to Lindenwald in the spring of 1841 that significant alterations were made. The alterations made by Van Buren during the early years of his residency can be characterized as changes that were designed to enlarge and improve the formal entertaining spaces of Lindenwald. The dating of the work is based on written documentation, paint-layering sequences, nail types, and molding profiles.

The most notable alteration made to the exterior of the house ca. 1840 was the replacement of the twelve-over-twelve window sash with six-over-six sash. The sidelights of the main entrance door were replaced with fixed sash comprised of three large lights surrounded by a border of smaller lights. The only sash not replaced at this time was the Gothic sash in the Venetian window. A new exterior door was installed in the west wall of room 105. The west slope of the roof also appears to have been resingled at this time.

Van Buren also changed the exterior paint scheme of Lindenwald ca. 1840. The brick was repainted light yellow, the trim and window sash cream, and the shutters green.

Alterations to the basement ca. 1840 were minimal. The moving of the basement stairs from the southeast corner of room 003 to the north wall of room 005 is the only change in the plan of basement rooms that occurred at this time. The moving of the stairs into room 005 decreased its size by 40 square feet. The design of the basement stairs is unknown because they were completely remodeled by Upjohn (ca. 1850). Van Buren made several other minor alterations to the basement. He may have installed the partitions that created rooms 002A and 003A. A letter from Harriet Butler to Van Buren suggests that he also improved the basement storage rooms, possibly adding wine racks, shelving, and door locks. Mrs. Butler says, "I am glad to hear from Smith that your storeroom is made. It will need a good lock and key" (Hardenbrook 1936, 16-17).

On the first floor Van Buren removed the U-shaped stairs at the west end of room 105. He also removed the partition that had been built across the center of the room. The removal of the stairs and partition created a larger room for formal entertaining than had previously been available at Lindenwald. It was probably the room in which the dining table, with a seating capacity of 30, was used.

New stairs to the second floor were built along the north wall of room 109. These stairs were completely rebuilt by Upjohn ca. 1850; therefore, information about their design is limited. They appear to have terminated at the level of the floors in rooms 105 and 109, in a passage between the rooms. This location and layout would have meant that the ca. 1840 stairs had a steeper pitch than the existing (Upjohn) stairs.

The building of these stairs reduced the size of room 109 by 60 square feet; it also destroyed its original L-shape. One other minor alteration associated with the building of these stairs was the moving of room 108's west wall 12" to the east. This change was necessary to fit in the run of basement stairs under the first-floor stairs.

Correspondence between Martin Van Buren and Harriet Butler in May 1841 indicates that all of the first-floor rooms were redecorated at this time. This redecorating took place after the removal and rebuilding of the stairs, to blend together the new and existing walls and woodwork.

As part of this redecorating campaign, all of the chair rails in the first-floor rooms were removed. No evidence of the chair rails was found on the walls built as part of the ca. 1840 stair alterations. The wooden fireplace mantelpieces in rooms 104 and 106 were also replaced with marble mantelpieces. Areas of plaster patching resulting from the removal of the chair rails and mantelpiece alterations were covered with a green lining paper.

The correspondence between Mrs. Butler and Van Buren indicates that all of the first-floor rooms had new wallpaper in 1841. The most outstanding and complete of the wallpaper is the Zuber scenic "Paysage a Chasse" that was hung in the hall. The scenic wallpaper was hung with the green lining paper. Small samples of the ca. 1841 wallpaper have been found in all the other first-floor rooms except room 101. In room 104 a star pattern paper (003) with a green border was hung. Rooms 106 and 109 were decorated with an embossed paper bearing a prominent gold-striped pattern and a delicate floral background (006). This wallpaper was hung with a flocked brown border. The woodwork in the first-floor rooms was repainted a cream color.

The 1841 redecorating of Lindenwald also included the installation of fireboards with scenic wallpaper for the first-floor rooms. The pier mirrors and first-floor carpets appear to have been installed at this time as well.

On the second floor, the alterations made by Van Buren were again associated with the moving of the stairs between the first and second floors. The stairs were moved out of room 206 into an area formerly part of room 210. The original wall between rooms 206 and 210 was taken down and replaced with a banister, creating an open stair hall. A new wall was built along the south wall of the stairs. This alteration reduced the area of room 209 by 85 square feet. Door 215 was reused in the east end of this wall. At some time after ca. 1840 and before 1862, doors 216 and 206 were installed in the west walls of rooms 209 and 205, respectively.

The second-floor rooms, like the first-floor rooms, were all redecorated in 1841. The chair rails were removed and new wallpaper hung. Samples of the wallpaper have been found in all the second-floor rooms except for room 209.

The wallpaper used in room 201 was a floral print on a gray ground (017), hung with a flocked floral border. Room 105 was redecorated with a wallpaper having a white ground and green, brown, and yellow foliate motifs (018). A green- and red-striped paper with a yellow diamond background (015) was hung in rooms 206, 207, and 208. In room 210 (Martin Jr.'s bedroom), a green and white floral paper (019) was hung; it had a flocked diamond pattern border.

Fireboards were also installed in the second-floor rooms ca. 1841. The fireboards in rooms 201 and 210 were covered with the wallpaper and borders used on the room's walls. Room 105, probably used as a guest bedroom, had a scenic fireboard. The fireboard for room 209 is problematical. It is slightly larger than the firebox opening, unlike the other Lindenwald fireboards, raising the question of whether it was actually used in this room. It was covered with the green lining paper used under the other ca. 1841 wallpaper and had a handsome gray Greek key border. Since room 209 is purported to be Van Buren's bedroom, it seems unlikely that the green lining paper found in the fireboard would have been used on the walls, as was the case in rooms 201 and 210. The woodwork on the second floor was painted cream.

In addition to redecorating the interior rooms, Van Buren also appears to have installed several mechanical conveniences at Lindenwald between 1841-49. The most elaborate of these conveniences was a mechanical bell system that connected all the first- and second-floor rooms to servants' rooms in the basement. The cranks for this system were mounted on the chimney breasts in each room. Also installed during this period was a system for heating fresh air at the back of the fireplaces in rooms 106 and 109. Writing to Gorham Worth on November 6, 1846, Van Buren mentioned a bath he had installed at Lindenwald: "When you visit me again you shall wash off the impurities of Mammon in the bath which has been put up in part with the interest you have [been] so kind as to collect for me" (Van Buren Papers, LOC). No evidence for a possible location in the existing house has been found. The statement that it had been recently "put up" suggests that it might have been housed in an outbuilding.

There is no indication that Van Buren made any alterations to the attic space ca. 1840.

D. 1849-1850

In 1849 Martin Van Buren made an agreement with his son, Smith Thompson Van Buren, to make him heir apparent to Lindenwald if he would take up residency there immediately. As part of this agreement, "Smith made it an indispensable condition that he should be permitted to add sufficient to my [Martin Van Buren's] house to make as many rooms as he may want without entering upon what I now have" (Martin Van Buren to Francis P. Blair, March 5, 1849, Van Buren Papers, LOC). To design this addition, Smith Thompson hired Richard Upjohn of New York City.

The Upjohn addition and the alterations completed in 1849-50 transformed the exterior of the handsome Georgian dwelling into an eclectic Italianate house, complete with a five-story tower. The addition was built across the west side of the original structure and across a small portion of its south wall. The wings that had stood in the area occupied by the new addition were demolished.

The addition was one story high with a full basement. The foundation below grade was stone, above grade it was faced with brick. The exterior walls were of brick. The roof consisted of one gable and two hip sections covered with terneplate.

The five-story tower at the southwest corner of the ca. 1797 house was of brick construction with a beveledere at the top. It had a gently sloping gable roof covered with terneplate.

In the roof of the addition, centered on the ca. 1797 hall, was a square skylight. It had a hipped roof covered with terneplate. The north, south, and west walls contained fixed sash of six lights. The east wall was formed by the west wall of the original house. A brick chimney was located at the junction of the flat and sloping parts of the hipped roof, above the north wall of room 118.

The typical window in the Upjohn addition was arched, with six-over-six sash. The sills of these windows were of brownstone supported by pairs of brownstone brackets. Each window was covered with a bracketed wooden hood. The roofs of the hoods were covered with terneplate. A variety of window sizes were used in the Upjohn addition, requiring variations in the size and number of lights in the sash. Their identifying characteristics, however, are the same as those of the large typical Upjohn window described above. The basement windows of the addition were all constructed with deep window wells.

There were two exterior doors in the first floor of the Upjohn addition (109 and 112). Door 109 was in the north wall of the addition at its east end. It was a double door; each half had three panels. The tops of the halves formed quarter circles. The semicircular door head was ringed by a glazed area containing six fixed lights. The door was flanked by side lights containing four fixed lights each. Door 112 was at the north end of the west elevation of the addition. It was a four-panel door with a segmental top. Above the door was a wooden pediment. In the center of the pediment was a circular window.

A third exterior door (012), of the same style as door 112, was in the west foundation wall. No physical evidence or photographic documentation has been found to suggest that this door ever had a hood. However, an iron anchor in the masonry to the south of this opening suggests that there was a cover for the bulkhead.

During the building of the Upjohn addition, numerous alterations were also made to the original house. An eclectic Romanesque/Gothic porch was built over the main entrance of the east elevation. The roof line of the house was reshaped by the addition of two secondary gables in the east and west slopes of the original gable

roof. Two dormers, flanked by scrolls, were also added to the east roof slope. The cornice and gutter system of the ca. 1797 house was rebuilt completely at this time. The new cornice consisted of a crown molding, with capping on the gable slopes and built-in gutters on the level eaves. Modillions were placed under the cornice overhang.

The Upjohn addition also resulted in extensive alterations to the fenestration of the ca. 1797 house. The pairs of windows in the gable ends of the house were filled in. In the north gable they were replaced with a single arched window; in the south gable the areas were taken over by the flues running to the new chimney at the gable peak. This new chimney replaced the two chimneys that had originally been at the south end of the house. The complex route of the flues to the new chimney precluded installing any windows in the south gable.

The windows in the west wall of the original house were all filled in when the Upjohn addition was built, except for window 213, which was rebuilt and incorporated into the skylight. A small window was cut in the west wall between the skylight and the tower. Other window additions in the ca. 1797 house included an oriel window on the second floor of the south elevation, a small window on the west side of the oriel window, and window 007 in the north wall of room 001 in the basement.

The building of the Upjohn addition increased the number of basement rooms by ten. The new rooms included room 006--the kitchen, room 007--the laundry, room 008--the stair hall, room 009--the basement entry, room 010--a transitional space, room 011--a chamber, room 012--a hall, room 013--a vaulted tunnel, room 014--the privy pit, and room 015--the coal storage room.

The kitchen had cabinets along the east wall, a sink and force pump in its southwest corner, and a cast-iron cookstove in the fireplace in the north wall. A brick bake oven was located in the northwest corner of the room. Documentation for the cast-iron cook stove indicates that it was manufactured and probably installed ca. 1850. It is not possible to tell whether it was installed during construction or shortly thereafter. The bake oven was probably sealed when the cook stove was installed.

The laundry room had a sink and pump along its south wall and a fireplace in its east wall. Room 009 (the entrance hall) had the house's cesspool underneath its floor. A flue opening in the south wall above a small brick platform suggests that a hot-water heater may have been in this room. Room 011 had a fireplace in its north wall. The asymmetrical placement of the doors and windows in the Upjohn basement addition is presented in the ca. 1849-50 plans and elevations (see appendix G).

The woodwork in the basement rooms of the addition was typical for Upjohn secondary spaces. Door and window casings were plain boards with bold cavettos on both edges. Many of the doors in the basement were reused from the ca. 1797 house. All basement rooms in the addition had plaster walls and ceilings except that room 013 had a cobble floor and brick walls and ceiling, room 015 had a brick floor, an

unplastered ceiling, two brick walls, and two stone walls, and room 012 had a brick floor. Plaster walls in the basement addition were whitewashed. Woodwork was painted a cream color except in room 006 where it was painted tan.

On the first floor the Upjohn addition increased the number of rooms by 12. These rooms included room 111--the library, room 112--a bedroom, room 113 (room 114 was later divided into two rooms, 113 and 117)--a stair hall, room 114--the bathroom, room 115--the water closet, room 116--a small hall, room 118--the nursery, room 119--the main entrance hall, room 120--a small hall, room 121--the privy, room 122--the closet, and room 123--probably a small bedroom.

Room 111, the library, was accessible from rooms 109 (D128) and 113 (D126). The door casing matches other typical Upjohn woodwork, and it was installed with cut nails. Paint on the plaster wall under this casing, however, indicates that it was not part of the original construction. Single windows were in the east and west walls of the library, a double bay window in its south wall. A fine Italianate marble fireplace was centered in the room's north wall.

Room 112, a bedroom, had doors connecting rooms 113 (D125) and 114 (D122). A pair of windows were in the room's west wall, a single window in the south wall. The fireplace stood in the center of the east wall. Its mantelpiece was moved, probably when this room was converted to a kitchen; however, the white marble pieces of it were stored in the house.

Room 113, the stair hall, provided access to rooms 111 (D126), 112 (D125), 116 (D118), 119 (D119), and 109 (D120). The first run of the tower stairs ascended the east wall of the room; stairs to the basement ran down the south and east walls.

Room 114, the bathroom, had doors leading into rooms 112 (D122) and 116 (D117). There was a single window in the west wall of the room and a small circular window in the east wall that provided light for the water closet. The bathtub was in the northwest corner of the room, the sink along the east wall. A simple marble fireplace was in the southeast corner.

Room 115 housed the water closet. Room 116 provided access from the bathroom to the water closet (D117) as well as passage from these rooms into room 113 (D118). Room 115 was separated from room 116 by a bifold door.

Room 118, the nursery, was accessible from room 119 (D115). A single window was in its west wall; a marble fireplace stood in the center of the north wall.

Room 119, the main entrance hall in the addition, was along the west wall of the original house. It was connected to the main entrance hall (room 105) of the 1797 structure by door 108. Access to rooms 120 (D114), 118 (D115), and 113 (D119) was also possible from room 119. A skylight was above the south end of room 119 (D109).

Room 120 was a small hall providing access to room 121 (D111) and 123 (D113) from outside (D112) and from the main hall, room 119 (D114). There were two steps in the west half of this room.

Room 121 was the privy, accessible only from room 120 (D111). Room 122 was a closet adjoining room 123 (D110). There is no evidence of early shelving in this closet. Room 123 was a bedroom, accessible from room 120 (D113).

The woodwork in the Upjohn addition was bold and simple. Moldings were large in contour and composed of circular shapes. Window and door casings in primary spaces (rooms 111, 113, 119) were composed of a large ovolo and fillets; in secondary spaces (rooms 112, 114, 115, 116, 118, 120, 121, 122, 123) the casings had flat surfaces with cavetto edges. Baseboards in primary spaces consisted of a scotia, torus, fillet, and cavetto; in secondary spaces they were plain, with a molded upper cavetto edge. Single window units included sliding shutters of 12 panels and segmentally arched outer casings and upper sash. The bay window shutters were hinged two-leaf shutters with separate upper and lower units. Wainscoting filled the area below the windows.

Doors in the Upjohn addition were four panel. Panels were recessed with an ogee and bead molding. Most doors were hung with five-knuckle eight-hole 4" by 4" cast-iron butt hinges.

Rooms 111, 112, 114, and 118 had elaborate molded plaster cornices. In room 111, the cornice was comprised of a cyma recta, cavetto, torus, fillet, and cavetto; in rooms 112, 114, and 118 it consisted of a fascia cyma recta, fillet, and bead.

The plaster walls in the Upjohn addition were either painted or wallpapered. The walls in room 111 were first finished with a light brown paint. This paint was applied before the passage between rooms 111 and 112 was opened. A fragment of wallpaper found behind the casings of door 127 suggests that the walls in this room may have been wallpapered soon after they were painted. The walls in room 112 were finished with a pink-and-white striped wallpaper (011). No evidence of the wall finishes in room 113 has been found thus far. However, the absence of early paint on the walls in this room suggests that they were wallpapered. In rooms 114, 115, and 116 (the three rooms that comprised the bathroom) the walls were painted with a cream-colored paint containing large blue pigment particles. A wallpaper with a blue ground and a pattern of flowers placed at the junction of gold diamonds (014) hung in room 118. No evidence has been found of the early finish in room 119. The absence of an early finish in a primary room suggests it was originally wallpapered, possibly with the same paper that was used in room 113. In rooms 120, 121, and 122 the original finish for the walls was the white plaster coat or possibly a layer of whitewash. The walls in room 123 may have been finished similarly. No evidence of their original finish has been found.

The woodwork in rooms 111, 112, 113, 117, 122, and 123 was painted tan. In the other rooms in the Upjohn addition, the woodwork was painted a cream color. In rooms 114, 115, and 116 large particles of blue pigment were added to the cream paint.

Accompanying the building of the Upjohn addition were numerous alterations to the interior of the ca. 1797 house. In the basement the space most radically altered was room 005. Door 021 became an interior, rather than exterior, door. Window 019 was enlarged. Both door and window had typical Upjohn casings with the cavetto molded edge. The arched chimney foundation in the south wall of this room was filled in. The door in the north wall of the room was reduced in size to become window 021. The stairs, including the rail, balusters, and newel post, were also rebuilt. The level of the floor was raised, and a new wooden floor laid. The walls were plastered, and a white-and-orange floral striped wallpaper (001) hung.

The other significant alteration made to the basement rooms, after 1854, was the plastering of the ceilings in rooms 002, 003, and 004. The walls in rooms 002 and 004 probably received a new coat of whitewash at this time as well.

On the first floor most of the Upjohn alterations were associated with the transformation of the exterior west wall of the ca. 1797 house into an interior wall. The west side of door 105, in the west wall of room 101, was bricked up and the passage converted into a closet that had double doors. In room 105, door 108 and its side lights were not altered. Correspondence between Smith Thompson Van Buren and Richard Upjohn indicates that a "glass door" was intended to replace door 108 (NPS, Platt 1982, 93). No evidence has been found to indicate that such a door was ever installed. Door 120 in the west wall of room 109 was reduced in size to accommodate the run of the tower stairs. This door and its casing were of black walnut and differed slightly from other Upjohn doors and casings in style and in the fact that they were not painted. Window 124 was reduced in size and made into a door providing passage between rooms 109 and 111.

Upjohn remodeled the stairs between the first and second floors. This remodeling included the filling in of the doorway in the north wall of room 109 that had allowed passage between this room and room 105. In room 105 the opening to the stairs was enlarged to the present arched opening supported by a carved bracket on the west wall. The stairs themselves were rebuilt in a less steep run. This was accomplished by building a landing, reached by two risers in room 105. Two molded wooden rails were attached to the walls of the stairs with metal brackets. The second-floor landing was not remodeled by Upjohn.

The finishes of the first-floor rooms were not changed as part of the Upjohn remodeling. New woodwork was painted to match the existing cream-colored woodwork; the ca. 1841 wallpaper continued to hang on the walls.

On the second floor room 210 received the most drastic alteration by Richard Upjohn. In order to create a passageway from the second-floor stair hall (R206, D211) to the tower stairs, the west wall of this room was moved approximately 4' to the east, a window was removed, and a door (214) was cut in the west wall. With the removal of the attic stairs from room 203 (described below), this passage became the only means of getting from the second to the third floor. The moving of the

wall reduced the size of room 210 by approximately 68 square feet and necessitated the filling in of the southwest window in this room. This window was replaced by a narrow, arched window (315) located half in room 211 (the newly created passageway) and half in room 307 (the room above). The other ca. 1797 window in the south wall of room 210 was also completely remodeled by Upjohn. It was replaced with an oriel containing two semicircular arched windows.

In room 206 the window in the west wall was transformed into an arched opening. It was retrimmed with a molded-plaster architrave, paneled wainscoting, and a wooden balustrade. This opening had no sash because it opened into the enclosed skylight well.

In room 201, the ca. 1797 window in the west wall was bricked in on its west side. The area occupied by the inner jambs was remodeled into a cupboard with three shelves and double doors.

The second floor/attic stairs were also removed from room 203 as part of the ca. 1849-50 work. Their removal was made possible by the remodeling of the attic space described below. Then a small closet area was created at the south end of room 203, accessible through door 210. Door 206, in room 205, which had been removed as part of the ca. 1810-15 William Van Ness alterations, was reinstalled approximately 2' farther north than its original location. This door provided access to room 203, as well as passage through that room into room 201. Door 205, also in the west wall of room 205, appears to have been installed soon after the removal of the stairs from room 203. This date is based on the paint layering on the door. The style of the door and its hardware, however, suggest that it postdates the ca. 1849-50 work. Evidence of a partition adjoining the north casing of door 205 indicates that its installation probably coincides with that of the door. An earlier (ca. 1797) partition, located 2' 7" south of the present casing of door 206, was also probably removed at this time. As on the first floor, alterations made to the second floor by Upjohn do not appear to have been accompanied by a major redecorating campaign. New woodwork was painted to match the existing woodwork. The ca. 1841 wallpapers remained on the walls.

Establishing access between the second and third floors via the tower stairs required the building of a corridor (room 307) directly above the second-floor corridor (room 211) at a height below that of the third floor. Stairs at the north end of this corridor directly above the first-floor stairs connected it to the new central hall of the third floor. Building this corridor required the removal of the west ends of the third-floor joists, notching the rafters, and providing other structural support for these elements.

As part of the Upjohn remodeling, the ca. 1797 attic space was transformed into three finished rooms and a hall. These rooms were located along the east side of the house. The area under the west slope of the original roof, except for a hall in the west secondary gable, remained unfinished. To the south of the west hall the unfinished area was inaccessible, to the north it could be reached through door 306; it was probably used for storage.

The third-floor rooms--servants' bedrooms--were T-shaped in plan. The leg of the T joined the main portion of the room to the dormer windows. The woodwork on the third floor consisted of reused doors and their casings from the ca. 1797 house, as well as new typical windows and casings for secondary Upjohn spaces. All woodwork was painted light gray. Walls and ceilings were plastered, then whitewashed.

With the building of the Upjohn addition, the mechanical systems at Lindenwald were expanded. An elaborate plumbing system was installed that consisted of sinks in the kitchen (room 006) and laundry (room 007) and a bathroom on the first floor with hot and cold running water (see section IV.C.3. for details). The bathroom (room 114/115/116) contained a bathtub, sink, and water closet. Wastes from the bathroom ran into a cesspool located in room 009.

The mechanical bell system was also expanded slightly when the Upjohn addition was completed. Evidence of the bell system has been found in rooms 005, 007, and 307. Room 005 was not part of the addition, but because it was completely remodeled by Upjohn, it is considered as dating to ca. 1849-50. The absence of the bell system in the first-floor rooms of the addition--the living areas of Smith Thompson Van Buren and his family--suggests that Van Buren's servants did not serve the private rooms of his son. This absence also lends support to the dating of the installation of the mechanical bell system to before the building of the Upjohn addition.

After completion of the Upjohn addition and during Martin Van Buren's residency (before 1863) at Lindenwald, several other alterations were made to the house. Between 1854-62 a hot air furnace was installed in the southwest corner of room 001. It was surrounded by a brick enclosure, from which hot-air ducts ran to the north rooms and central halls on the first and second floors. A duct also ran to the main entrance hall in the ca. 1849 addition (room 119).

Van Buren redecorated one of the rooms in the ca. 1797 house in 1858. On May 3 of that year he wrote to Mrs. Henry Gilpin that "we have had the old room papered and painted and made more charming on your account" (Gilpin Papers). The room to which Van Buren referred cannot be positively identified. It may have been the southeast parlor where a wallpaper that stylistically dates to this time has been found. No other wallpaper has been found that can be dated to ca. 1858.

Martin Van Buren died in 1862. The agreement between Smith Thompson Van Buren and his father to leave Lindenwald to this son never materialized. Van Buren's will read as follows:

I hereby give, devise, & bequeath to my three sons Abraham, John, & Smith Thompson . . . all my real estate wheresoever situated, to be equally divided between them, their heirs & assigns forever, subject to the following conditions & reservations, viz first that out of the . . . receipts of the Sale of Lindenwald there shall be reserved & paid over to my son Smith Thompson, his heirs or assigns the sum of seven thousand five hundred dollars in full satisfaction for his

advances towards the expenses incurred by the additions to and improvements upon the dwelling House & outbuildings with the expectations that the place would be devised to him upon terms that would be equitable in respect to his brothers, the payment to be without interest during my life time (Van Buren Will).

E. 1863-1874

In the decade following Van Buren's death the ownership of Lindenwald changed hands four times. From 1863 to 1864, it was owned by his son John Van Buren. In 1864 the property was purchased by Leonard Jerome, who owned it until 1867. George Wilder owned the property from 1867 to 1873, and for five months (1873-74) John Van Buren and James Van Alstyne, distant relatives of Martin Van Buren, owned the house. No significant alterations can be dated to this decade.

F. 1874-1917

In 1874 Lindenwald was purchased by the Wagoner family. During the early years of their residency at Lindenwald, physical evidence suggests that they practiced general maintenance on the exterior of the house and limited redecorating of the interior rooms. On the exterior, it seems likely that the house was repainted. Physical evidence indicates that it had been painted last ca. 1850, so that by ca. 1874 it was no doubt in need of repainting. The brick of the house was painted white, the trim brown, the shutters red, and the sash white.

In basement rooms 005 and 006, the woodwork was grained. Probably also at this time, the other painted woodwork in the basement was painted brown. The force pump in the southwest corner of room 006 was replaced when this room was redecorated.

Evidence of redecorating on the first and second floors during the early years of the Wagoners' occupation is sketchy. Room 112 appears to have been repapered twice during these years (WP012 and 013), and the woodwork was grained. The walls in room 114 were repainted a dark green, the woodwork a cream color. In the other first- and second-floor rooms, paint layering sequences indicate that the woodwork was repainted. A Japanese-style wallpaper (016) was hung in rooms 206, 207, and 208 (ca. 1880). At this time a floral paper (007) was hung in room 106.

In ca. 1890 the Wagoners appear to have undertaken a more ambitious campaign of exterior maintenance and interior remodeling. The basement windows on the east side of the house (W001, 002, 005, and 006) were rebuilt. Their sills were raised, reducing the size of the window opening, and new sash installed. The roof on the original portion of the house was reshingled, and the terneplate roof on the Upjohn addition was probably repainted. The final complete repainting of the exterior house was also part of this work. The walls were painted white, the wood trim cream, the shutters brown, and the sash white. The lightning rods may also have been installed as part of this work. Their date of installation is unknown, but they do appear in the earliest photographs of Lindenwald (ca. 1890).

On the interior, ca. 1890 the Wagoners moved the kitchen from room 006 to room 112. The moving of the kitchen to the first floor appears to coincide with the abandonment of the basement rooms for living space. After this time, they were used merely for storage.

To accommodate the kitchen, numerous alterations were made to room 112. A sink was installed along the south wall, and a stove on the west side of the room. The exact location of this stove is unknown; however, the stovepipe ran into the newly built chimney at the west end of the gable above this room. An exterior door (112A) was cut into the west wall. Paint analysis indicates that the original door 118 was reused in this location. This door (ca. 1890) probably had a simple set of steps; later a porch was built across the back part of the house.

The finishes in room 112 were also changed to accommodate the kitchen. Three layers of wallpaper (111, 112, 113) found under the casing of door 112A were stripped from the walls. The walls and ceiling were then painted a tan color. The woodwork was reglained.

Evidence found in rooms 114, 115, and 116 indicates that this bathroom was abandoned when the kitchen was moved to the first floor. The bathtub and sink were removed from room 114 at this time; the water closet and its tank in room 115 were left in place. The cover of the water closet was closed and shelving built between it and the tank above. The bifold door (138) separating room 115 from 116 was removed and reused as door 118. Door 117 was installed between rooms 114 and 118. Door 123 in the southwest corner of room 114 may also date to this remodeling. However, the lack of a casing around this door and an unclear sequence of paint layers on its surface suggests that it may date to the building of the back porch, early in the 20th century. The walls in room 114 were repainted dark green after the bathroom fixtures were removed; the woodwork was grained. In rooms 115 and 116 the woodwork was also grained; the plaster walls retained their original paint.

It is unknown what use rooms 114, 115, and 116 were put to after ca. 1890. They may have served as a large pantry for the adjoining kitchen, but this is merely speculation. Also unknown is whether a bathroom was installed elsewhere in the house at this time. The lack of evidence for one suggests that the indoor and outdoor privies were the only sanitary facilities at Lindenwald until 1920, when bathrooms in the present location were installed.

In room 113, the arched opening at the first-floor level of the tower was filled in with a wooden partition, containing a door in its center. This partition created room 117. The partition and the woodwork in rooms 113 and 117 were grained. No evidence of the ca. 1890 finish on the plaster walls in these rooms has been found.

In the other interior rooms at Lindenwald, some of the woodwork may have been repainted ca. 1890. No wallpaper dating to this period has been found.

G. 1917-1957

During the 20th century minor alterations were made to Lindenwald. With the exception of the work done by Kenneth Campbell ca. 1960, this work was spread over the seven decades and does not represent any identifiable periods of building. On the exterior of the house this work included the following:

A new sloping deck was added over the original tower deck (date unknown).

A tie rod was installed to stabilize the front arch beam of the front porch (date unknown). Before 1925 this tie rod was removed and replaced with interior diagonal braces.

The wood shingle roofs were replaced with slate (ca. 1917).

A porch was added along the west wall of room 112 and part of the west wall of room 114. This porch was probably added ca. 1920. It first appears in the 1936 Weig report photographs.

The front porch was removed in 1950.

Several interior alterations were undertaken. Among these were the following:

Selected first- and second-floor rooms were redecorated in 1921 and 1945. In 1945 the scenic wallpaper was removed from the west wall of room 105, and this wall surface painted. In 1945 many of the carpets were removed and the floors painted gray.

Bathrooms were installed on the first and second floors between the main rooms on the north side of the ca. 1797 house. This work was probably done in the 1920s. A well, pump, and pressure tank, as well as a septic tank, are implied by this work. It was probably at this time that a door was installed at the south end of the east wall of the northwest room on the first floor.

Electricity was installed ca. 1936-37

A kerosene floor heater was installed in room 105 (the central hall) ca. 1935.

A door was installed between the first-floor southwest room and the main stairs. A door was also installed in the arched opening between the stairs and the central hall. These changes probably relate to the 1945-1947 nursing home use of the house.

The bathroom on the south side, first floor, was installed after 1938, probably ca. 1945.

A steam-heating system was installed in the early 1950s.

In 1957 Kenneth Campbell purchased Lindenwald from the DeProse family. As the new owner, he transformed the exterior appearance of the house with the addition of a colossal, tetrastyle porch

across its east elevation. The porch had a flat roof and balustrade. Campbell enlarged window 302 into a door to provide access to the porch roof. On the ca. 1797 portion of the house Campbell replaced the overhanging bracketed cornices and built-in gutters. He also added new siding to the dormers. In the Upjohn addition he replaced the pairs of arched windows in rooms 111 and 112 with large multipaned windows. Campbell also repainted the wood trim, sash, and shutters white. Certain decorative elements of the wood trim were painted black.

On the interior Campbell's major alterations related to kitchens and bathrooms. In room 112 (the existing kitchen) he removed the fireplace mantel and installed a stove along the east wall. He lowered the ceiling in this room and painted the walls and ceiling numerous times. He also installed a kitchen in room 210. This work involved running water and drainage pipes up to the room. Base cabinets were installed along the east wall and a stove in front of the fireplace. The ceiling was lowered in this room. On the second floor, Campbell enlarged the north bathroom by moving the east wall of room 201 approximately 4' to the west. This created an area for the bathtub and a closet. He also lowered ceilings in rooms 201, 205, 114, and 118 and rewallpapered many of the first- and second-floor rooms and repainted their woodwork. During Campbell's residency both the attic and basement were used for storage. Few, if any, alterations were made to these rooms.

IV. Architectural Description

A. Exterior

1. Dimensions and Orientation

In plan, the 1797 portion of Lindenwald is a rectangle, 58'9" across the front and 45'5" deep. The line of the front of the house is oriented 48 degrees east of magnetic north. Compass declination for this location is approximately 12 degrees west of true north; therefore, the line of the front wall of the house is oriented 36 degrees east of true north. For convenience in writing this report, the front wall has been designated the east wall and other compass directions have been assigned accordingly.

The ca. 1850 addition is a rectangle 25' deep and 68'8" long. It is built onto the west wall of the house with its north end in line with the north wall of the 1797 house. A 5'6" by 20'8" bay projects to the west of this rectangle at its south end, and a 10' by 22' by 19'6" bay wraps around the southeast corner of this rectangle and extends 9'10" onto the south wall of the 1797 house.

2. Number and Height of Stories

The 1797 house is two and one-half stories with a full basement. The basement floor varies somewhat in elevation but is roughly 8'5" below the first floor. The second floor is 12'2" above the first, and the third floor is 12'1" above the second. The third floor ceiling is 8'7" above the floor, and the roof ridge is 2'2" above that. The first floor is 3'6" above grade at the front door, thus the roof ridge is 38'6" above grade. Grade is within 6" of level around the foundation.

The 1850 addition is one and one-half stories high except for the tower, which rises to a height of approximately 63'9" above grade. The first-floor level of the addition is the same as that of the 1797 house. The basement floor, for the most part, is 9'2" below the first floor. The attic floor is 13'4" above the first floor.

3. Foundations

The foundation of the 1797 house is of rubble stone construction approximately 2'5" thick. Spread footings at the base of the foundation taper gradually outward to a maximum of 1'4" from the plane of the wall above and rest on a compact sand at 5'2" below grade. The inside surface of the 1797 footings has not been exposed. The above-grade portions of the foundation wall have received a number of finish treatments through the years. The earliest treatment was found under the modern (ca. 1960) front porch (removed summer 1978) in an area that was concealed behind the 1850 porch. At least part of this area (under the front door) may have been concealed behind the earliest front porch or stoop. The finish in this area (the stonework between W003 and W004) consisted of horizontal and vertical lines of white paint over the rubble masonry to give the appearance of coursed ashlar (see IP001). All other areas of the 1797 foundation walls received a light parge coat (or a heavy whitewash) scored in an ashlar pattern, painted brown all over, then penciled white over the score lines. Subsequent paint layers of rust, dark gray, cream, and brown (P350) omitted the white joint lines. The brown paint over cream primer is considered the historic finish and

corresponds to the historic trim color (Munsell 2.5YR 4/2). (For further discussion, see section VI.C. of this report.)

The mortar of the 1797 stone foundation has been found (see section VI.F) to consist of approximately four parts lime, seven parts sand, and four parts fines (passing a no. 200 sieve).* The proportions are subject to variation because of weathering effects and sampling errors. The mortar joints in the stone foundation have deteriorated as a result of normal weathering, structural movements, and "rising damp." About 75 percent of the surface needs to be repointed.

The foundations of the ca. 1850 addition are coursed rubble masonry with exterior brick veneer, laid in American bond and capped by a brownstone water table approximately 3' above present grade. The brick veneer extends 5" to 10" below grade, and the stone foundation extends straight down (without a spread footing) to rest on a compact sand at 6'11" below present grade. The wall is 1'9" thick, with an 8" to 12" spread footing projecting on the inside whose top surface is 7" above the base of the wall. Outside the privy, the footing extends to 9'2" below grade. Information on below-grade configurations of foundation walls is based on archeological testing.** Conditions in other areas may differ from those discussed here. The above-grade portion of this foundation was painted the same color as the 1797 foundation during the historic period (Munsell 2.5YR 4/2).

The mortar formulation for repointing should replace the fines that were present historically with a portion of cement (white Portland) and lime so that the ratio of matrix to sand found in the original mix is maintained. Fines in a mortar require excessive cementitious material to coat the increased surface area presented by many small particles and to reduce the weather resistance of the mortar. The removal of fines from the mix will make exact color matching difficult, but the mortar is to be covered with a coat of paint. The mason's sand readily available at several local sand and gravel suppliers is a very good match for the historic sand without the undesirable fines.

4. Wall Construction and Surface

The exterior walls of the 1797 portion of Lindenwald are of solid brick construction approximately 20" thick including a 1" to 1-1/2" plaster on the inside surface. The bricks vary in size. Length ranges from 9" to 9-3/8", width from 4-1/4" to 4-1/2". The majority of units fall in the middle one-third of those ranges. The height is virtually constant at 2-1/4". Bed joints range from 3/8" to 3/4", head joints from 1/4" to 1/2". Thirteen courses and joints equal 36". The brick bond pattern is English bond (alternating courses of stretchers and headers) on the north and west walls. The closure of these courses at the corners is a rather

*The fines are a very fine sand or silt. The material does not have the cohesion or plasticity of clay.

**For specific areas that were tested and more detailed discussion of findings, see NPS, Fiero 1983.

unusual composition of a stretcher and queen closer added to the header courses and a header added to the stretcher courses (see IP002). The east wall and south wall are laid in Flemish bond (alternating headers and stretchers in each course). The east wall corners are handled with a standard queen closer. The south wall does not have a standard pattern of closure. Some courses have queen closers, others have the unusual closure pattern found on the north and west walls.

The transition between the stone foundation and the east brick wall is accomplished with a molded brick water table consisting of two header courses in a *cyma reversa* profile (convex below, concave above). On the north and south sides the concave upper course is omitted, and on the west side the water table is omitted entirely. Two courses of brick project to form a belt course at the second-floor level on the north, east, and south walls.

The brick walls are four wythes of brick (19") thick from the water table to the eaves level with the third floor. The north and south gables are two wythes (9") thick, with flues projecting on the inside. The east and west gables, also two wythes thick, were added ca. 1849 and are identical to the walls of the rest of the addition.

The 1797 brick walls were first painted brick red with white penciled joints. Early in the 19th century the walls were painted white, at least twice;* they were painted light yellow twice, once before and once during the ca. 1850 building campaign. The walls have been repainted white twice since 1850. Paint layers are completely weathered off of most areas of 1797 brickwork. The samples used to determine the above paint sequence were taken from protected locations (see section VI.C.).

The bricks themselves, though somewhat soft, are generally in good condition. A few bricks have been broken by minor, apparently nonrecurring, structural movement. A few others exhibit general crumbling, probably as a result of moisture penetration or insufficient firing of the brick.

The 1797 mortar joints are tooled and ruled to create the profile shown below:

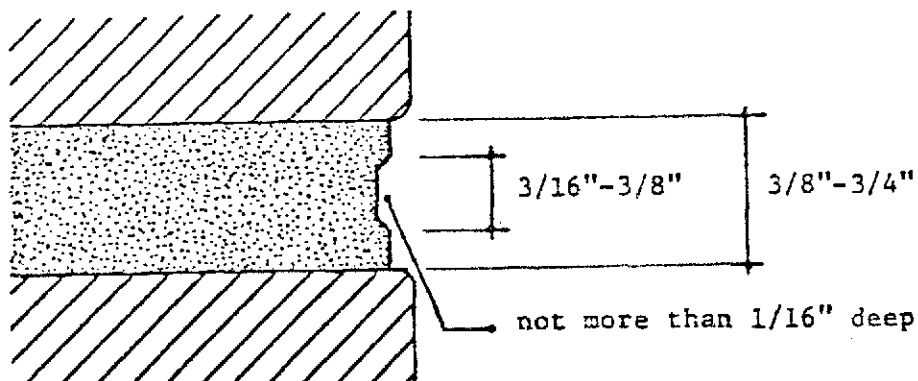

*In a letter referring to an 1845 visit, the house is described as being painted white on the exterior. (See "A Visit to Kinderhook," New York History 35 (1954).

Most of the joints have been weathered to the extent that the joint profile is no longer perceptible. About 50 percent of the mortar joints are so deteriorated that they must be repointed. This deterioration is the result of a variety of causes: normal weathering, slight structural movements, and previous inappropriate repointing with Portland cement mortar. The 1797 brick mortar has been found to consist of roughly two parts lime, two parts sand, and one part fines (passing a no. 200 sieve).

The exterior walls of the 1850 addition to Lindenwald are of brick and wood-frame construction, with a cavity between the brick of the exterior wall and the lath and plaster; the wood studs secure the latter to the interior of the brick and carry wood lath and plaster as an interior finish. The brick walls are laid in American bond with headers every sixth course. Walls are two wythes (8") thick. The 1850 bricks are more regular in size than the earlier bricks. All dimensions are very close to 8" by 2-1/2" by 4". Ten courses equals 2'5". The average mortar joint is approximately 5/8". The 1850 mortar was found to consist of roughly three parts sand to one part lime. This proportion is probably sandier than the original mortar mix. All areas were deteriorated by water leaching out the lime and thereby increasing the concentration of sand. The exterior mortar was so badly deteriorated that the North Atlantic Regional Office found it necessary to undertake a contract (CX-1600-7-0056) for repointing the entire ca. 1850 addition as an emergency stabilization project. The mortar mix used then was one part Ironclad Portland cement, two parts lime, and six parts mason's sand from a local supplier. All brickwork on the ca. 1850 addition was painted a light yellow color during the historic period.

The recommended restoration treatment for the brickwork is to repaint it with a light yellow color (Munsell 2.5YR 9/2) in a vinyl acrylic latex paint. The vinyl acrylic latex is chosen for its high permeability, superior alkali resistance, gloss, and color retention. The brownstone water table should be left unpainted.

The sand used in the brickwork is the same as that used in the stone foundations and can be matched very well by any number of local suppliers. As previously stated, the fines can be omitted as long as the sand/matrix ratio remains the same.

5. Roof Construction and Surface

The original roof of the 1797 part of the house was a simple gable bound at the rakes by four chimneys. Judging from the extant evidence in the sheathing and roof framing, there were no dormers or secondary gables. East and west eaves were level, north and south were raking. The roof slope was (and still is) approximately 25 degrees.

The original roof covering, based on shingle characteristics, nail type, and absence of evidence of other layers of roofing, survives under the east gable and consists of 24" eastern white pine shingles, rived and drawn, with the corners beveled so that the butts appear octagonal or rounded. These shingles are attached with early cut nails, used elsewhere in the 1797 construction, which have two-facet handmade heads. Each course of shingles is exposed 6-1/2" to 7". Documentary evidence suggests the possibility that wood shingles

were painted gray ca. 1815, although the only extant paint evidence consists of red paint remnants on the ca. 1797 shingles. In a letter of May 9, 1815, from H. Skinner to William Van Ness, the following is stated about the roofs: "For the roof you will add such quantity of lampblack as will give it the proper shade - I think a very dark paint is the handsomest" (Van Ness Papers). No traces of such a paint have been found, indicating that Van Ness did not follow the suggestion or that any paint applied ca. 1815 weathered off and the red remnants are from a later period. Other documentary evidence for painting roof shingles (specific roof not indicated) includes the following entry in a list of May-November 1858 expenditures of Smith Thompson Van Buren: "140 pds. of dark color for roofs" (Van Buren Papers, LOC).

The shingles are nailed directly to sash-sawn sheathing boards, 3/4" to 7/8" thick, of widths ranging from 8" to 1'3" (see IP004). The edges are planed square. Boards are spaced about 1" apart and attached to the rafters with rose-headed wrought nails, two per board per rafter, 1" from the edges.

There was a hatch on the west slope adjacent to the ridge and 18'6" from the north edge of the roof (see IP003). This area contains evidence of a number of alterations. The evidence for the original hatch consists of two pairs of 2" by 3" mortises at the tops of the adjacent rafters. The rafter faces are 3'10" apart, and the centers of the mortises are 1'1/2" and 3'10" from the ridge. Thus, the maximum possible original opening would have been 3'10" by 2'7-1/2". The present cover for the opening in the ceiling below is a 3'4-1/2" by 2'6" board-and-batten rectangle assembled with wrought nails. Two additional battens, attached with cut nails, are used to hold in place a 4" board that increases the original width of the cover from 2'2" to the present 2'6". The fact that the original battens are not centered on the cover suggests that one or both ends may have been cut down to fit the present lower opening. There is no evidence to indicate if the opening was flashed or framed in a curb, or what the outside covering material was and whether the outside cover extended all the way to the ridge to obviate the need for flashing.

The second opening in this location covered the original mortises with reused scraps of lumber that framed an opening 3'6" wide and 3'0" along the roof slope. These framing members are painted different colors and contain empty nail holes and inscriptions such as "P. S. Danforth," "1831," and "J. J. Slingerlands." The 3 in 1831 is difficult to read and could be interpreted as a 4 or a 9. Since this date is unclear and could relate to the original use of the board or could have been written much later, it is of no value in dating the alteration.

The sheathing boards currently sealing off the opening contain two sets of shingle nails, plus the slate nails, implying it was sealed during the Upjohn renovations, ca. 1850 (these nail patterns are described in section VI.D.4.a.). This information suggests that the hatch may have been altered when the west slope was reshingled and closed during the ca. 1850 roof alterations, even though a hatch was placed in the ceiling below at the same time. The ceiling hatch gave access to an attic crawl space, and the closing of the roof opening may

have been done when an iron ladder was installed between window 307 and the roof of the addition.

Rafters are hand hewn, tapering from approximately 6" by 8" at the eaves to approximately 5-1/2" by 6-1/2" at the ridge. They are spaced an average of 4'5" on center, with extremes of 3'11" and 5'0". The rafters rest on 6" by 9" posts at the ridge (see IP005) and are mortised-and-tenoned and are pegged into the floor joists at the eaves. The posts are also mortised-and-tenoned and pegged into the floor joists over a central north-south bearing wall. Because of this bearing wall, a structural system that would otherwise be a truss behaves as simply supported rafters (see IP006). The actual behavior of the rafters is complicated somewhat by the presence of vertical braces near the midpoint of each span and diagonal braces between the ridge post and each rafter, but the rafters have been calculated to be structurally adequate as simple spans, so the braces can be ignored.

Flashing would have been required where the chimneys penetrated the roof, but no physical evidence of original flashing has been discovered. (In general, metal flashing was not common at this period.) The gutter, eave, and cornice configuration cannot be determined because all evidence of it was destroyed in the course of constructing the built-in gutter and modillion cornice ca. 1850. A section of cornice molding with a hollowed-out top surface, found in room 004, may be a survivor of the original cornice/gutter treatment. No evidence of the original ridge treatment has been discovered.

Evidence of a later reroofing was found under the ca. 1850 west gable. An area of square-butted, 18", rived-and-drawn eastern white pine shingles were laid (with 5-3/8" to 6" exposed to the weather) and attached directly to the sheathing with 1-3/8" cut nails that had early machine-made heads and rounded points. One nail found in this context has a sheared point. Round points are generally considered to be pre-1830, sheared points post-1830 (see section VI.D.). Although one cannot base a conclusion on one nail, the presence of both types in one context may indicate that the shingles on the west side of the roof were replaced during the transition period, ca. 1830, but probably no later.

This physical evidence conflicts with the documentary evidence and some confirming physical evidence, which suggests strongly that Lindenwald was neglected during William Paulding's ownership from 1824 to 1839. The documentary evidence is contained in a letter dated July 21, 1841, from Martin Van Buren to Levi Woodbury:

My success in improving my place has far exceeded my sanguine anticipations. The expenses, owing to the extent of the place, the size of the house, etc., and the length of time it has been substantially unoccupied, have, it is true been great (Blair Papers).

The physical evidence that tends to confirm this period of neglect is the wholesale replacement of sash ca. 1840 and the extremely weathered paint layer on the shutters (see sections IV.A.10. and VI.C. for further discussions).

The ca. 1850 alterations to the 1797 part of the roof included the addition of secondary gables at the centers of the east and west slopes (see IP007) and narrow dormers on the east slope flanking the secondary gable. The south chimneys were rebuilt to reroute their flues into a single large chimney at the roof ridge. The entire eave, gutter, and cornice assembly was altered.

The secondary gables were added by placing 4" by 5" rafters at a 41.5 degree slope directly on top of the original roof sheathing, with no apparent regard for the locations of the rafters beneath. Thus, concentrated loads from the gables are transferred directly to sheathing boards that are only marginally adequate to carry the uniformly distributed load of the maximum expected snowstorm without this additional concentrated load. Snow loads have not caused the collapse of the sheathing boards and the secondary gables but appear to have caused deflections sufficient to result in leaks along the valleys between the main roof and the secondary gables. Rotted areas at the tops of the rafters under these valleys are a strong indication that this excessive deflection has occurred in the past. Sheathing for the secondary gables is 5/4" boards attached with modern cut nails. In addition to the wire nail holes for the present slate roof, there are two sets of square nail holes (indicating cut nails), both of which exhibit a 5-1/2" spacing of shingle courses. One set of courses represents the ca. 1850 roofing, the other a replacement shingle roof that was probably installed before the 1890s when wire nails are generally considered to have superseded cut nails (Edgerton; Fontana et al. 1962).

To create the space under the east gable, sheathing was removed ca. 1850 from the two central rafter spaces, the central rafter was cut at 7' below the ridge, and its load was transferred to the adjacent rafters using a 1" by 6" header. Normally this would not be an adequate header, but because of the short span and the secondary gable roof above, it will not have to be reinforced. For the space under the west gable, the sheathing was removed from one rafter spacing; the rafters were not disturbed.

Two dormers that were added ca. 1850 to the east slope of the main roof occupy the space between two rafters. Their vertical cheeks rest on the rafters and carry a small gable roof with flared eaves. The east wall of both dormers is dominated by a round-headed, six-over-six, double-hung window and embellished with a box sill, open work scrolls, and a bracket-and-modillion raking cornice. The cheeks are covered with 1" vertical boards of random widths from 8" to 9-1/2". The roof slope is approximately 46 degrees. The virtually level eave area is covered with terne-coated sheet metal with flat seams. Standard pan size of these sheets is 10" by 14". Although in extremely poor condition, these areas of sheet metal appear to be from the 1850 period because of the similarity in pan size and joinery to the surviving 1850 batten seam roof on the addition. Two sets of square nail holes and one set of round holes found on the dormer sheathing match those found on the gable sheathing.

Also ca. 1850, board nailers were installed under the roof sheathing at the midpoints between rafters. They provide no reinforcement for a uniform load, but they do serve to transfer

concentrated loads, such as people walking on the roof, to adjacent sheathing boards. These boards must have been installed prior to the third-floor plaster ceiling (ca. 1850, see section IV.B.4).

Determining the details of the roof alterations made during Upjohn's ca. 1850 renovations involves the examination of a variety of data. Since the addition of gables and dormers to the original roof, as well as alterations to the cornice, involved a considerable disturbance to the roof surface, it can be logically concluded that the roof received a new covering at this time. The nail patterns found on the ca. 1850 gables indicate that this new covering was of wood shingles. Physical evidence for other details is slight because the ca. 1850 shingles were replaced by a later wood shingling, and then these wood shingles were superseded by slate installed ca. 1917* (see HP14). Further information concerning the roof configuration can be seen in photographs of the house exterior. The earliest of these (HP5) was probably taken about 1890 and may well record the most recent, rather than the ca. 1850, wood shingle roof. However, judging from the cornice appearance in this photograph and its correlation to that in the Upjohn rendering (see HP4), as well as other details of the dormers and gables, it would appear that the roof was little changed in 1890 from its 1850 appearance. Much of the 1850 cornice on the main house roof no longer exists because it was altered by Campbell during the 1950s, when rake capping boards were removed and the slate was extended to the outer edge of the cornice.**

In examining the photographs of the house taken after historical photograph 5, a gradual deterioration of roof elements can be recorded. The scrolls bracketing the dormers become loose, dormer box sills are askew, and the box sill returns (ends) are missing. The photographs show a wood shingle roof with comb or ridge boards, a heavy projecting cornice having modillions below the soffit, and rake capping boards with a metal covering. Lacking other evidence, it can be assumed that the comb boards are of exposed wood, as was typically used, and then possibly painted. It is difficult to judge the cause of differences in value seen in black-and-white photographs. A difference in texture, reflectance angle, or color could account for such difference. Since we do not know the color if we were to assume the comb boards were painted, it seems best to assume that they weren't.

The rake capping boards are a different matter. Historical photograph 41, dated between 1946 and 1950, is in color and clearly shows the metal covering painted red, with an additional lapped flashing added on top. This lapped flashing shows in earlier photographs so it

*Recollections of the DeProsse family indicate that they installed the slate roof shortly after purchasing the house in 1917.

**Information supplied by Kenneth Campbell before his death.

can be concluded that the metal covering painted red in historical photograph 41 must have existed and must have been painted red before 1937 (HP18) since both photographs show the lapped flashing. This earlier photograph (HP18) shows work being done on the roof, possibly the slate being installed (ca. 1917), and includes the lapped flashing on the rake. If this photograph does depict the slate installation, then the metal capping boards cover flashing that would predate ca. 1917. Although it is difficult to confirm that the capping boards were covered with metal in 1850, historical photograph 5 (ca. 1890) shows the capping boards as being dark in value, as are the metal roofs, and not as light as the wooden comb boards or shingles. A close examination of historical photograph 6 reveals darker horizontal lines on the capping board, which may be the seams between sheet metal pans. In addition, cut nails similar to those used on the terne-coated metal roof of the ca. 1849 addition still attached small fragments of sheet metal to raking dormer cornices. Therefore, it can be assumed that the metal covering existed ca. 1890 and may well have existed in 1850, as apparently did the dormer eave flashing mentioned above.

A careful examination of historical photograph 10 reveals a change in the slope of the board capping of the south main gable as it approached the level eave on the east side. At first glance the change appears to be a clockwise twist because the distinct shadow at the inner edge of the capping narrows abruptly. The line of the outer edge of the capping is much less distinct because there is less contrast between the capping and the sky/tree branch background, and because there is no vertical plane surface comparable to the one at the inner edge of the board. However, when a straightedge is held against the edges of the capping board, it becomes apparent that both edges change slope twice at about the same points and angles. Since the capping board seems to meet the level eave squarely and the downward tilts do not involve any twisting, the upper portion of the capping board must be parallel to the roof surface. The apparent reason for the change of slope in the capping board is an irregularity in the underlying brickwork such that the top of the bricks at the southeast corner is 2" higher than at the other corners.

The higher brickwork at this corner and on the south gable means that the roof surface must be higher as well. However, the cornice across the front (east) elevation is level from corner to corner. The capping board must therefore slope downward more sharply at the east end of the south gable to meet the level cornice.

Historical photographs 5 and 6 show side views of the east secondary gable and the south dormer. These photographs give the general impression that the peaks of the capping boards are parallel to the ridges (and therefore horizontal). Placing a straightedge along the peaks of the capping boards does not provide much additional information because the line of the peak is so short that the straightedge can be rotated 10 degrees in either direction from horizontal before one notices a discrepancy between the line of the straightedge and the line of the capping board. Enlarging the photographs to make the line longer only results in blurry images, making it impossible to distinguish the actual images from grains of silver in the photographic emulsion. The fact that

the rotation is equal in both directions before a discrepancy is noted could be interpreted as a further indication that the peak is horizontal. In historical photographs 11, 24, 26, 34, and 37, there appears a small block of wood at the eastern end of the north gable capping board. It is applied at an angle, apparently to divert rainwater flowing down the top of the capping board into the gutter. Such a device would only be necessary if the board was parallel to the roof surface, since water would run off one side or the other if the board was canted. There are two items of comparative data which apply to this detail. A drawing labeled "Dormer Windows for C.H. Russell's House/Newport, R.I./Richard Upjohn & Co. Architects" (see IP008) from Avery Library shows a dormer with horizontal capping boards. This was designed by Upjohn in 1852-1853 (Upjohn 1939, 202). The capping boards on the tower and on the west gable of the Upjohn addition to Lindenwald are parallel to the adjacent roof surfaces.

Because all physical evidence of the capping boards was destroyed by Ken Campbell in the 1950s, and the photographic evidence is inconclusive, the project historical architect recommends that the prototypes of Upjohn's designs for the C.H. Russell house and the addition to Lindenwald be followed and that the rake capping boards be restored with their top surfaces parallel to the adjacent roof surfaces except for the east end of the south gable, which should be restored with the two changes in slope.

The evidence pertaining to the configuration of the raking eave capping boards is subject to a second interpretation. The following presentation and interpretation of evidence was prepared by the North Atlantic Historic Preservation Center.

Another detail derived from an examination of these photographs is that the rake copings of the main roof, gables, and dormers were pitched outward so that the coping sloped away from the roof rather than being parallel to it. The reason for such a detail may have been to shed water away from the junction of roof shingles and the raised coping. By placing an extra thickness of shingles along the rake, water running down the roof would also be shed away from this junction. Evidence for the slope of the main rake coping can be seen in historical photograph 8 where the lower end of the coping appears to taper. Actually, the coping twists at this point from the slope to a plane parallel to the roof surface. Historical photograph 10 shows this quite clearly. A straightedge laid along the outer edge of the coping shows this edge to be continuous and straight, whereas the inner edge of the coping is not continuously straight but dips down near its lower end so that it meets the gutter along a common parallel. Similar evidence of slope at the other end of the roof can be seen in historical photograph 34, where the lapped edges of the cover flashing are clearly not parallel to the slate coursing.

Historical photographs 8 and 10 were taken when the roofing was still of wood shingles. The copings on the dormers and gable were removed when the slate roof was installed. However, the coping on the main roof rakes remained, and the slope can be seen on the north rake in historical photograph 34. Evidence of the coping slope

on the dormers and central gable can be seen in historical photographs 6 and 10, which date from the early 20th century. In these photographs it can be seen that a line tangent and parallel to the line of the intersection of the copings when extended does not lie parallel to the dormer ridge. The same is true of the intersection of the gable copings (see HP6). Through the use of reverse perspective, a determination of the slope of the coping has been figured at approximately 6 degrees, or a 1" rise across the coping face.

The North Atlantic Historic Preservation Center is conducting additional research on this subject. If that research leads to a different recommendation, the results will be presented in the project completion report.

Paint lines on the surviving sheet-metal-covered eaves of the dormers suggest that the coping face was 10" wide. Using the reverse perspective technique mentioned above, this dimension for the dormer rake coping was confirmed, as well as the dimensions for the rake coping face of the central gable and the main roof gable. These dimensions were 10" and 12" respectively.

The cornice, gutters, and eaves of the 1797 portion of the house were removed ca. 1850 and replaced by a modillion cornice with built-in (sometimes called "Yankee") gutters. The cornice consists of box modillions roughly 6" wide, 7-1/4" high, and projecting 1'3-3/8" from the brick wall. The joint between these boxes and the soffit is covered by a molding that consists of a cavetto below and torus above linked in one continuous curve. The corona supports a cyma recta and fillet. The tops and bottoms of modillions under the raking eaves are parallel to the roof slope, and the sides are vertical. The dormers have a similar cornice on a smaller scale appropriate to their size. The corners and peaks of the dormer roofs are carried on somewhat intricately shaped brackets. A box sill covers the roof area between the dormer window and the gutter (actually overhangs the gutter) and projects beyond the sides of the dormer where open work scrolls rest on it. The four scrolls survive in pieces (not on the building), with only a small section at the bottom missing from each one. Other small sections that are missing from one scroll are present on one or more of the others. Historic photographs and surviving adjacent materials made it possible to reconstruct the small missing pieces within a tolerance of 1/4".

The valleys between the secondary gables and the main roof slope are flashed with terne-coated iron sheets 14" by 20" laid with the long dimension in the direction of flow. A thin, triangular wood shim was installed under the flashing on the main roof side of the valley. Its purpose was to prevent the runoff from the steeper secondary gable from running over the edge of the valley flashing onto the main roof sheathing. The line of this shim is directly beneath the line of the shingles above. The sheet metal was exposed in an "open valley" approximately 8" wide. The only paint that survives on the metal is a red iron oxide. This kind of paint was used as a primer on ca. 1850 work in other areas. Here, it may be a primer or a later top coat. The top coats found on other ca. 1850 sheet metal were a dark green on the

roof of the one-story addition (see paint sample 005) and dark brown (matching the wood trim color) on the tower deck (see paint sample 727). The dark green paint was also found on sheets of terne-coat flashing between the tower and the main roof and on lead flashing on the south dormer at the juncture of the board capping and the level eaves. Subject to the discovery of contradictory information, it is recommended that all historic flashing and coping be painted dark green. Those flashings for which we have no historic data, and especially those which are added in areas where there was no flashing historically, should be painted to "disappear," i.e., the same color as adjacent materials.

The roof of the one-story addition consists of a flat section and sloping areas intersecting to form two hipped sections and one gable. The "Specifications of Carpenters Work . . ." described "the outer covering to be IX leaded tin and the slope of the roof to be ribbed with 1-1/4 x 1-3/4" pine ribs rounded thus and placed 2.0 ft. from centres" (see appendix C). Each section, or "pan," is a terne (tin and

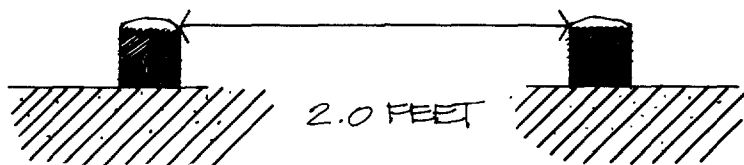

lead) plated iron sheet, 14" by 20", fastened together with flat lock seams of approximately 1/2". The 14" dimension is horizontal. The pans that make the transition between the flat and sloping roof areas are hemmed and soldered onto the sloping roof pans. There are two pan widths for each batten division, with two pans covering the batten in a simple overlap at the top and face-nailed with cut nails. The batten ends are covered with this same overlap and face nailing. The terneplate gutter liner pans originally joined the lower edge of the sloping roof in a flat lock seam, apparently left unsoldered for expansion and contraction.

The composition of the terneplate, examined in a scanning electron microscope with an attached EDAX detector, is a low carbon steel base with a 60 percent lead, 17 to 18 percent tin coating, with traces of silicon, aluminum, and magnesium (see appendix N).

Careful study of the condition of this roof in 1977 resulted in an evaluation report written by John G. Waite of the Preservation/Design Group, dated May 5, 1977 (see appendix J). Contract work was performed during the late summer and autumn months of 1978 and 1979.

The completed terneplate preservation work (documented through North Atlantic Regional Office contract specifications and drawings) has resulted in

a new 30-gauge terne-coated stainless steel flat roof laid in the same joint pattern as the original layout, with 14" by 20" sheets, flat seams, and new flashing along the junction of the flat roof with the west wall of the 1797 structure, the monitor-type skylight, and the tower

new 30-gauge terne-coated carbon steel gutter liners laid in the same manner as the original layout, with exceptions in the drip edge and locking strip between the liner and sloping roof edge

two new 30-gauge terne-coated carbon steel valleys at the west and south

new chimney flashings

paint removal, cleaning, patching, and priming of all original sloping roof terneplates

a change from the existing red paint color to green (see section VI.C.1.)

The primer used on the new terne-coated metal during this work has failed in adhesion.

The following work is recommended:

Restore the roof as shown in construction documents entitled "Lindenwald Roof Restoration" and "Lindenwald Sheet Metal Work."

Repaint the new sections of sheet metal installed under CX-1600-7-0056 and CS-1600-9-0036.

6. Porches and Stoops

During the historic period, Lindenwald had two porches and a stoop. They were the front porch leading to door 101, the north porch leading to door 109, and the back stoop leading to door 112. When it was acquired by the National Park Service in 1974, Lindenwald's front facade was covered by a colossal tetrastyle verandah (see frontispiece). This porch was added ca. 1958 by the last private owner of Lindenwald, Kenneth Campbell. It was removed by the Park Service in the summer of 1978. The Park Service also removed a 20th century screened-in porch that was attached to the west wall of rooms 112 and 114. These two porches were clearly nonhistoric and will not be discussed further.

The front porch was designed by Richard Upjohn and was the last element of his additions to Lindenwald to be completed, according to a letter from Martin Van Buren to Mrs. H.D. Gilpin on December 2, 1850 (Gilpin Papers). It replaced a smaller porch that is known only by a print of unknown origin assumed to be pre-1850 (see HP1 and the archeological evidence presented in NPS, Fiero 1983). The front porch design is amply represented in historic photographs, the Upjohn rendering, and surviving fragments.

Unlike the front porch, the north porch is inadequately represented in historic photographs, and there are no known drawings or surviving pieces. The few historic photographs we have date to the 1930s. There is no way to verify that the porch shown in those photographs is the historic one. The one that appears on the HABS drawings was erected by Kenneth Campbell ca. 1958 and removed by the Park Service ca. 1977. The porch shown in the 1930s photographs has a landing one step below the first-floor level, which fills the recessed area at door 109. Then five risers lead down to exterior grade. All exposed material is wood. Risers and cheeks are closed, stringers are open, and there are no railings. In the absence of information or physical evidence of an earlier porch, we recommend reconstruction of the north porch that appears in 1930s photographs or construction of a new porch to allow handicapped access.

The back stoop at door 112 is shown in photographs from the 1920s and 1930s (HP9 and HP-23). These photographs show stone steps without a landing and a shallow pedimented hood. Paint layers on the hood match other woodwork of the 1850 period. The paint layers on the present board cap and drip edge indicate that it was added at a later date, although it shows in the 1920s photograph (HP9). The upper portion of the face of the pediment is missing the two earliest paint layers. This indicates that the original cornice was applied to the front of the pediment. This cornice should be restored using the paint line as a dimensional guide and the molding profiles from other historic features of the house. The date of construction of the present stone steps is cast into doubt by the fact that they were laid on a concrete block base (reputed to have been done by Kenneth Campbell) and by the presence of a bricked-in door opening (D010) directly below door 112 leading to the vaulted "tunnel" room (see IP009). Archeological investigations in the summer of 1978 revealed a walled-in area under these stone steps. Analysis of artifacts from the fill deposit in this area indicates that it was not filled until after the end of the historic period (1862). (For a more detailed discussion of this point, see NPS, Fiero 1983.) For a total restoration, it is recommended that the stone steps be excavated again, carefully recorded and dismantled, and then reconstructed in a more durable manner. The stone steps should be reconstructed to a configuration consistent with the structure beneath, and utilizing the same stones.

7. Bulkhead

The bulkhead outside door 012 provided the only direct exterior access to the basement during the historic period. The earliest available photograph of this feature (HP11D) dates to the mid-1930s. It shows the brick coping around the bulkhead opening but no cover. The bulkhead is sheltered only by the overhanging roof of the nonhistoric back porch. A rusted iron anchor embedded in the brickwork south of door 012 may have connected the framework for a bulkhead cover to the wall of the house (see the bulkhead section schematic).

The cheeks of the bulkhead are of brick construction, butted against the foundation wall. Each stair tread is a single stone the full width and depth of the step. Height is usually adjusted by use of another masonry material under the tread. Treads are worked into the

Bulkhead Section

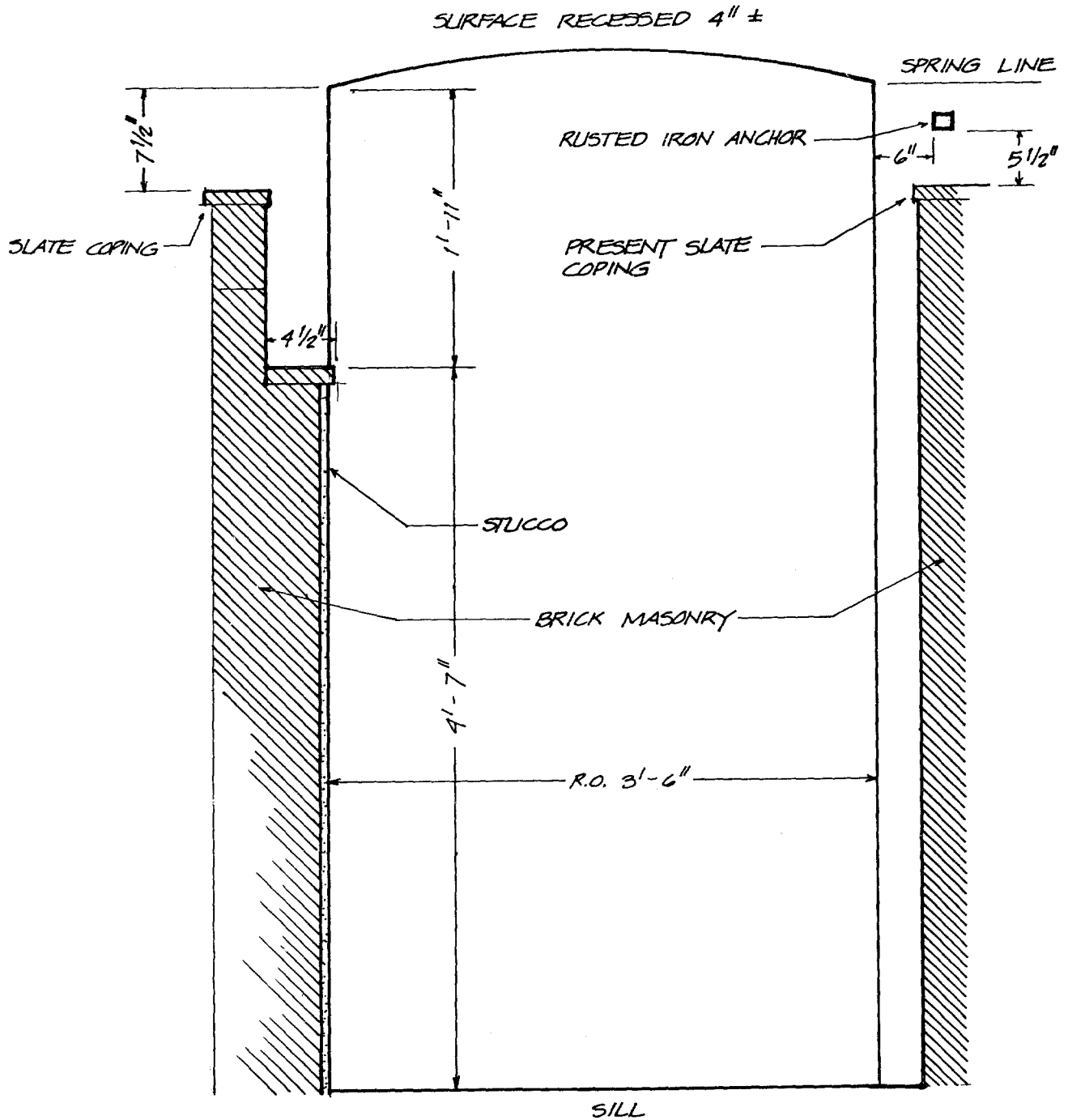

BULKHEAD SECTION

SCALE: 1" = 1' - 0"

brickwork of the cheeks. A rowlock course seems to be the original coping of the cheek walls. As soil accumulated through the years, four courses of brick were added to the cheeks, and the riser heights were adjusted to keep the bulkhead in proper relation to grade. The bulkhead should be restored to its historic height consistent with the present height of the south cheek, and an appropriate bulkhead cover should be constructed.

8. Window Wells

There are eight window wells of varying construction around the perimeter of the house, plus the remains of four (WW001, 002, 005, 006) across the front where the windows were later reduced in size and the wells filled in. They have been given number designations according to the numbers of the windows they surround--window wells 007, 011, 012-013, 014, 015, 016-018, and 019. All but wells 007 and 019 are attached to the ca. 1850 addition. Based on the adjoining window configuration and on archeological data, we can definitely state that window well 019 was built ca. 1850. The segmental brick arch, exterior iron bars, sash, and molding profiles are all typical of this period. Judging from the fact that the ca. 1850 stone sill now lies below grade and its top is level with the bottom of the three brick courses of well 007, it is assumed that the well was added when the wood sill was replaced and raised (see section IV.B.1). Two window wells are oversized (roughly 2'0" by 5'8" and 2'0" by 4'8") to serve the paired windows (W012 and 013, and W016 and 017, respectively). The standard inside dimensions for all the others are 2'0" by 3'6". All the window wells have rowlock brick coping. Other construction details vary from concrete block walls to poured concrete to parged brick to brick over a battered fieldstone foundation. The last is the construction of the only window well (012-013) that seems to have survived undisturbed since its construction. All but well 007 were provided with external iron bars for security (WW007 has internal bars). Window wells 011, 012-013, and 014 were equipped with partial vertical bars covering the upper parts of the windows and horizontal bars over the tops of the window well openings connected to the vertical bars. Window well 012-013 consists of a stone outer wall set 29" from the foundation wall of the addition, battered to about 20" from the window sill at the bottom, and vertical cheek walls of brick. The rowlock coping and three courses of brick in these side walls appear to be set with cement mortar, and they continue across on top of the stone outer wall. Across each window opening is a set of vertical iron rods, pointed at the top and set between two horizontal iron bars (see IP 010) attached to the mortar joints on either side. The lower of these iron bars (through which are bored two holes spaced 19-3/4" apart for the bar across W013 and 19-5/8" for W012) is set vertically against the brick surface. The level of this lower bar is 28-1/4" above the stone sill and even with the top of the outer stone wall and with the bottom of the brick courses laid in cement mortar.* Over this well is an iron grate

*The wood sill at this location is missing and has been replaced with mortar. Evidence of a sloping cut in the stiles shows the pitch and thickness of this earlier sill.

composed of 35 bars (one is missing) set on edge between two longer bars that span the length of the well. One of the longer end bars has two sets of holes through it, one pair spaced at 19-3/4" and the other at 19-5/8". Clearly, the grate was once attached to the lower horizontal bars of the window grills at a level 11-1/2" to 12-1/2" below the top of the present brick coping. William DeProsse, while on a visit to Lindenwald on July 7, 1981, remembered removing large slabs of bluestone coping from the walls of the window wells. Pieces of this bluestone still remain on the site, the side pieces with notches out of one end. The remainder of the window wells are equipped with vertical bars which are set in the window sill, pass through a horizontal bar level with the top of the window well, and terminate in points.

Because it is nonhistoric (and in most cases obviously so), the masonry work of the window wells should be reconstructed to match well 012-013. Iron work should be repaired and missing elements should be replaced in kind. If foundation drains are required, the masonry work on window wells should be coordinated with the installation of drains. This work should be preceded by careful archeological excavation, or it should be monitored by trained archeologists.

9. Coal Chute

A below-grade bricked-in opening (W009) on the north side of room 015 is believed to have served as the outlet for a coal chute during the historic period (see IP011). Upjohn's drawings of other houses around this time frequently include coal chutes. The presence of a coal pile in room 015 and its proximity to the furnace support this hypothesis. Although the furnace was not installed until 1854 or after, fuel was certainly required for other heating equipment. In fact, a letter from Martin Van Buren to Mrs. E. T. Throop, dated February 26, 1852, clearly indicates that the fuel was coal: "By changing our coal we have made our house as comfortable as we could possibly desire it to be" (Throop and Martin Papers). Archeological investigations should be undertaken to determine (if possible) the configuration of the coal chute. Then the coal chute should be reconstructed or restored as necessary.

10. Windows and Shutters

Exterior windows at Lindenwald have been assigned three digit reference numbers. The first digit designates the floor level (0-basement, 1-first, etc.). The second and third digits indicate sequence starting at the south end of the front (east) elevation and proceeding counterclockwise. All windows are in masonry openings. Most are vertical sliding sash; windows 003, 004, 007, 008, 010, 114, 115, 311, 312, 313, 314, 315, 401, 402, and 403 are casements; windows 001, 002, 005, 006, 103, 104, 111, 112, 214, 308, 309, 310, 501, 502, 503, and 504 are fixed; windows 212, 304, 306, 316, and 317 have been bricked in; windows 118, 119, 122, and 123 have been changed from paired windows to multiple-pane fixed "picture" windows; and window 302 has been changed to a door.

a. Vertical Sliding Sash

There are two styles of vertical sliding sash windows: the six-over-six rectangular openings spanned by brick flat arches in the 1797 portion of the house, and the segmental-arched six-over-six sash in

the ca. 1850 addition. The 1797 openings average 6'7" by 3'9" (see IP012). The wood frame members measure roughly 2" by 6" overall, with a beaded stop, parting strip, and interior stop bead applied. The lower sash measures 3'4" by 3'9" and the upper sash 3'3-1/2" by 3'9". Only the lower sash is counterbalanced. Each sash contains six lights (three wide) 18-13/16" by 13-7/16". This is an odd dimension; window glass is normally supplied in full inch sizes. The round-headed, or Gothic, sash of the Palladian window (204), which has four lights across (see IP013), is the only remaining original sash on the first or second floor.* It suggests that the original sash were twelve-over-twelve with 10" by 12" lights (the size present in W204 and calculated to fit perfectly the other 1797 sash openings). As a result of paint analysis and hardware study (see sections VI.C. and D.), the six-over-six sash have been determined to date from Van Buren's ca. 1840 improvements, with the odd dimension of the lights the result of having to fit a three-light-wide sash into a four-light-wide opening.

The exterior shutters (actually shutter blinds according to Cyril Harris, Dictionary of Architecture and Construction, 1975) for these windows measure 6'7" by 1'11". The frames are of mortise-and-tenon construction, with a middle rail forming two panel areas of movable slats. Hinges are wrought straps with round ends, offset in the plane of the blind and perpendicular to the blind so that they will lie flat against the brick walls in the open position. The shutter blinds swing on wrought-iron pintles with integral baseplates which are attached to the window frames by handmade screws. One pindle at W208 is a "drive" type, having a wrought spike with a diamond-shaped head that holds the pin upright. The holdbacks (dogs) on the north and south sides are wrought spikes with strips of spring steel riveted to their tops and driven into mortar joints. The bottom rail of the blind slides over the spring, forcing it down as it passes over and then allowing it to spring back to hold the blind against the wall. The dogs on the east (front) side of the house are propeller-shaped wrought iron bars that pivot on the end of a wrought spike driven into the mortar joint.

It is not possible to precisely date the installation of these shutter blinds. The wrought-iron hardware suggests a date before 1850 when cast-iron shutter hinges with integral holdbacks became readily available. Movable louvers are believed to date after 1810. Paint evidence indicates a date in the range 1810 to 1830. The first finish coat of green is weathered; therefore, it was exposed for some time before being painted over with a second coat. The second coat of green has been associated with Van Buren's 1840 alterations because the third coat (cream) matches the 1850 paint for the body of the house. The physical evidence also points to a date between 1810 and 1830. The use of louvered shutter blinds painted green is generally indicative of the Greek

*This is based on the style of muntin and the paint layers found in this sash and the fact that it was common in many New England churches when modernizing or replacing sash to retain the upper Palladian sash because of the difficulty in its replacement.

Revival stylistic period and would probably not be found much before 1820. The general state of neglect that seems to have prevailed before Van Buren's purchase of the property in 1839 suggests that Paulding did not maintain the house. If this is true, then the shutter blinds were probably installed before his purchase of the property in 1824. The weathered first finish coat of green paint would relate to this period of neglect.

The second major group of vertical sliding sash at Lindenwald are the double hung, segmental-arched windows in the ca. 1850 addition. These vary in size from the eight-over-eight basement windows with nine-by-twelve lights that measure 3'4" by 4'7" overall (011, 014, 015, 018, and 019); to the four-over-four basement windows with nine-by-twelve lights that measure 1'9" by 4'7" overall (012, 013, 016, and 017); to the four-over-four first-floor windows with twelve-by-eighteen lights that measure 2'4" by 6'7" (118, 119, 122, and 123); to the six-over-six first-floor windows with twelve-by-eighteen lights that measure 3'4" by 6'7" overall (see IP014); to the six-over-six dormer windows with ten-by-sixteen lights that measure 2'11" by 5'10" overall; and finally to the four-over-four gable windows with twelve-by-sixteen lights that measure 2'6" by 6'0" overall. All of these windows share the construction details shown on sheet 6 of drawing 460/25,000. Paint sequences for all of these windows are standard for the ca. 1850 addition. Some of these windows have been damaged by condensation and subsequent fungal attack, but only minor repairs will be required to return them to service.

b. Casements

The six-light (three across, two high) casement sash at windows 003 and 004 contain seven-by-nine lights and measure 2'1-1/2" by 1'11-1/2" overall. Paint layering (P516), molding profiles, and hardware (wrought-iron HL hinges) all indicate a 1797 date for these frames and sash. The sash are in good condition, but the frames, especially the heads, are badly rotted. Consolidation with epoxies should be sufficient for most of the frames, but the lintels will require partial or total replacement with new material.

Window 007 is a double in-swinging casement with two four-light sash. The muntin profile of the sash is typical of ca. 1850 work. The frame and surrounding masonry date to 1797. The exterior sill was inaccessible; however, the interior shows clearly that the sill was raised by masonry infill. This change either predated or coincided with the installation of the ca. 1850 casement sash. Mortar analysis was inconclusive. The sash and frame are in good condition and need only normal maintenance work.

Window 008 is a single-light, in-swinging sash hinged at the top. The masonry opening is 2'9" by 1'4-1/2"; the sash is 2'5-3/4" by 1'2"; and the light is 2'2" by 10". The single layer of latex paint and the standard 1-5/8" by 5-1/2" size of the frame members indicate recent construction but the masonry opening appears to be historic. Because its present appearance is obtrusively modern, the entire window unit should be replaced with something modeled after W007.

Window 010 is a single-light, hopper-style sash 1'3-1/2" by 1'11-3/4" in a frame measuring 1'8" by 2'3-1/2" overall. The presence of a joist bearing on a 1" by 3" plate spanning the window opening leads one to doubt that this opening is historic. The exterior masonry around this opening is different from all of the known ca. 1850 openings. There is no brick arch. The opening is spanned by the stone water table.

Windows 114 and 115 are paired, narrow, arched-top windows that share a hood. Window 114 provides light for room 122, and window 115 for room 121, the privy. Both windows are casements hung on butt hinges with four lights arranged vertically. Both are in good condition and require only normal maintenance work.

Windows 311 and 315 are narrow, arched-top windows that were inserted in the 1797 brickwork during the ca. 1850 alterations. Both provide light to room 307, and window 315 also provides light to room 211. Both are casements with three lights arranged vertically, but window 315 is both wider and taller. These windows are in good condition and need only normal maintenance work.

Windows 312, 313, 314, 401, 402, and 403 are narrow, arched-top casement windows that provide light for the tower stair. All have four lights arranged vertically. All are in good condition and need only normal maintenance work.

c. Fixed Windows

Windows 001, 002, 005, and 006 are three-light (arranged horizontally) sash measuring 1'2" by 3'4" and held in place by "cupboard buttons" or "thumb turns" of the modern stamped sheet metal variety. The millwork of the frames is standard dimension lumber, but cut nails were used in the assembly. Of course, cut nails are still being used, but their incidence of use decreased drastically after 1900. Heads and sills are dadoed to receive the jambs, and nails are driven through the heads and sills into the end grain of the jambs. The only paint found on the sash or frames is latex except for one sample from the frame of window 001, which tested positive for lead-based pigment. Thus, the present sash must have been installed in the past 25 years, but the frames seem to be older. Historic photographs of ca. 1900 show windows of the same configuration; however, brick infill within the stone masonry openings clearly indicates that the original window openings were 11" deeper than the present openings. When this change occurred cannot be determined. The mortar in the brickwork is indistinguishable from ca. 1850 mortar, but there is no reason to think that such a mortar could not have been used anytime in the 19th century. The present sash are not the ones that were installed at the time of the change, so no useful information can be obtained from them. Since the present sash are obtrusively modern, replacement windows should be reconstructed as they appear in the earliest photographs. Masonry openings should remain the same as they are now. Window frames and sash should be based on the historic photographs and the historic muntin profile.

Windows 103 and 104 are the sidelights to the front door. They are 5'1-1/2" by 1'10-5/8" with fifteen lights arranged as

three central lights, each of which is 1'3/4" by 1'5", and with a 3" border all around. These sash occupy the inner tracks of former vertical sliding sash windows. The upper sash were 2'1" by 1'10-5/8" and lower sash were 3'1-1/2" by 1'10-5/8". One of the upper sash was found in the basement reused as window 026. It has four 9" by 11" lights. Paint studies confirm that the present fixed sash were installed ca. 1840 when other sash were changed from twelve-over-twelve to six-over-six. The muntin pattern for these windows is similar to that for windows 203 and 205, but the latter are vertical sliding sash. Windows 103 and 104 are in good condition and need only normal maintenance work.

Windows 111 and 112 are the sidelights and arched-transom lights for door 109. The sidelights are 6'4-3/4" by 1'3-3/4" with four 12" by 18" lights arranged vertically. The transoms are paired continuations of the sidelights curving inward over the door to form an arch. Two sidelights and two transom lights are broken and should be repaired or replaced. Otherwise, these windows are in good condition and need only normal maintenance.

Window 214 is a round fixed window in the west gable of the ca. 1850 addition. It contains four quarter-circle lights. It has recently been repaired by the park maintenance staff and will require no further treatment at this time.

Windows 308, 309, and 310 occupy the three sides of the skylights on the ca. 1850 addition. They are all 6'9" by 1'10" six-light sash with 12" by 16" panes.

In place on the skylight there are also eight-light storm sash 1'1-1/2" by 5'0" with 5" by 14" lights and additional wood framing pieces added to all four sides to bring the sash out to fill the opening. The muntin profile indicates that the prime sash are historic, but the jury-rigged nature of the storm sash and their muntin profile indicate that they are not historic. The discrepancy between the muntin pattern of the storm sash and the prime sash makes the former obtrusive. Since storm sash are desirable for energy conservation, particularly in this location, the nonhistoric storm sash should be removed and replaced with ones that duplicate the muntin pattern of the prime sash. The difference should not be noticeable to visitors. The prime windows are in good condition and need only normal maintenance.

Windows 501, 502, 503, and 504 are tall, arched windows that are paired on the north and south sides of the top of the tower. They are 8'1" by 1'4" overall with five 12" by 18" lights. They have recently been repaired by the park maintenance staff and will require no further treatment at this time.

d. Bricked-in Windows

Windows 212, 304, 306, 316, and 317 were all bricked in during the ca. 1850 additions and alterations. Window 212 was closed because the roof of the addition cut across it. Windows 304 and 306 were apparently closed for reasons of style. They were replaced with window 305, a round-headed window on the north facade. Window 304 would have supplied light to room 303, but the dormer (W303) gave it light instead.

Window 306 was at the end of an interior partition, but such interference was readily resolved in favor of style in the case of window 305, where a king post was removed from the roof structure and a partition was offset so that a central window could give light to an off-center hallway. Windows 316 and 317 were closed for stylistic and technical reasons. Upjohn's design for the south elevation of Lindenwald called for a massive single chimney at the peak of the gable. Flues running into this massive chimney traversed the former locations of windows 316 and 317, requiring that they be filled in. All of this infill brickwork is laid in American bond, butted to the old openings, and distinct from the Flemish or English bond of the surrounding brickwork. The original brick flat arches over the openings were left in place.

e. Picture Windows

Historically windows 118, 119, 122, and 123 were double-hung arched-top four-over-four windows paired under window hoods. They were removed ca. 1960 and replaced with large pseudo-Colonial multipaned picture windows. These windows should now be removed and replaced with reproductions or restorations of the historic windows. Ample evidence survives in photographs and actual pieces of millwork for the restoration of these windows.

f. Window Changed to Door

Window 302 was changed to a door to provide access to the roof of the front porch that was added ca. 1960. Evidence for the window configuration is found in photographs, in sash tracks in the opening, and in butt joints where the sill originally joined the window frame. This window should be restored.

g. Recommendations

The "normal maintenance" work required for most windows will include complete removal and replacement of putty. All putty is badly weathered, cracked, and missing in places. This will enable untraviolet filter material to be applied to the full inner surface of the glass while it is removed for reputtying and will avoid the usual telltale clear lines around the edges of each pane.

11. Doors and Doorways

When acquired by the National Park Service, Lindenwald had seven exterior doors. Three were not historic. Door 302 was historically a window as described above. The upper portion of this door originally came from first-floor window 118, 119, 122, or 123 and had an arched head and was sized to fit these openings. The lower portion of door 302 is of the correct size and number of panels to fit the space for the missing interior sliding shutter of window 118 or 119. Doors 123 and 124 were cut through the historic brick walls some time late in the 19th century. Dating evidence is presented in the descriptions of rooms 112 and 114. The exterior evidence consists of broken bricks, irregular bonding of the door jambs, and the lack of brick arches over the openings. Moldings, hardware, and paint evidence confirm this conclusion.

The historic exterior doors are 101, 109, 112, and 012. Door 101 is the front door of the 1797 house. It is a Dutch door 3'11" wide by 7'11" high overall. The lower leaf is 3'4" high; the upper leaf is

4'8" high and carries a copper alloy door knocker with a silver plate engraved "1797," which is believed to be original to the house (see IP015). There is no cause to doubt that this is the same door and knocker that Van Buren "preserved . . . as interesting memorials of my last interview with its original owner" (Fitzpatrick 1920, 7). The design of the knocker is quite similar to one "found in a Birmingham [England] trade catalogue, item No. 489, page watermarked 1803" (Newark Museum 1963, 150, 158). Both leaves of the door still swing on their original HL hinges. Other hardware has been altered. Paint lines on the door and a dutchman in the jamb indicate the former presence of a 6-3/4" by 11-3/4" rimlock. The present lock is a mortise lock with a night bolt; it is fully described in section VI.D. and dated to Van Buren's ca. 1840 alterations. The doorway is surrounded by an architrave that is in turn framed by pilasters and an entablature. The shaft of the pilaster is a recessed panel; its "capital" is a gougework sunburst motif. The jambs and head of the doorway are decorated with panels that correspond to the panels on the door itself. The doorway is flanked by the sidelights (W103 and 104) described in the preceding section. During restoration work in the summer of 1980, two areas of stucco, tooled and painted to look like brick, were discovered above the sidelights. The paint layering on these patches indicated that they were part of the original construction. The patches cover the wood lintel that spans the door and sidelight openings.

Door 109 was the main entrance to the ca. 1850 addition designed by Richard Upjohn. It is on the north side of the house where the addition joins the main structure. The opening for the door is formed by a semicircular brick arch that springs from brick walls on both sides. The door itself is a double door with a round head and three panels on each leaf. Sidelights and quarter-circle transoms fill the space between the door and the masonry surround. The sill under this door is so badly rotted that it must be replaced with preservative-treated wood. Otherwise, the doorway is in excellent condition and needs only to be given normal maintenance and painted the historic color. The 20th century screen door and screen transom panel should be removed.

12. Chimneys and Flashing

Of the three chimneys on the 1797 roof, two are in their original locations. They are on the north end of the house at the midpoints of either side of the gable roof. Each chimney serves two fireplaces; the northwest chimney contained the historic furnace flue and contains the present furnace flue.

The earliest illustration showing the north chimneys is the ca. 1849 Upjohn rendering.* It shows a small portion of the top of the northeast chimney. The south side of the chimney appears to have two arched openings formed by colonnettes, with a capping of corbeled brick and dentils. This treatment is the same as on the south chimney but at a smaller scale. No evidence, either photographic or physical, has been found that indicates that the alterations proposed by Upjohn were ever carried out.

*The north chimneys do not appear in the ca. 1847 engraving of Lindenwald.

The next illustration that shows the north chimneys in detail is in the 1936 Weig report. Earlier photographs (HP5 and HP8 dating to ca. 1890 and ca. 1900 respectively) show only the south chimney. In the ca. 1890 photograph the south chimney appears to have a final course of brownstone; in the ca. 1900 photograph this chimney has five courses of corbeling. It is impossible to determine whether the north chimneys ever had the simple brownstone capping found on the south chimney; however, since photographic and physical evidence indicates these chimneys were rebuilt several times, it should be considered a distinct possibility.

In the Weig report, the north chimneys appear as follows. Counting up from the lower edge of the gable roof, there are twelve courses of brick, a bluestone water table, three courses of brick, a fourth and fifth course of brick containing brownstone ledges (two on the south and north sides and one on the east and west sides), and thirteen additional courses of brick on the northeast chimney, twelve on the northwest chimney topped by five courses of corbeling.

When Lindenwald was acquired by the National Park Service in 1974, these chimneys appeared to have been extensively rebuilt and repointed. Joints and the edges of the water table showed extensive decay and were filled with a Portland cement.

In 1978 the northwest chimney was repointed and its upper five courses were relaid as part of the terne plate roof preservation contract. This northwest chimney received attention because of its deteriorated mortar joints and active function as the furnace flue. During the summer of 1980 both the northwest and the northeast chimneys were completely rebuilt above the water table. As a result, they consist of twelve courses of brick, the bluestone water table, three courses of brick, and fourth and fifth courses of brick containing the brownstone ledges. Above the ledges are twelve additional courses of brick, capped by four courses of corbeling. The fifth course of corbeling will be simulated by a sheet metal chimney cap. The brick in the chimneys measures approximately 8" long, 3-1/2" wide, and 2-1/4" thick. The mortar joints are approximately 3/4" wide. The mortar used to repoint the chimneys consists of ten parts sand, four parts lime, and one-half part White Medusa Portland cement. The present chimneys are similar to the chimneys shown in the 1936 Weig photographs.

No evidence has been found of the early flashing for the north chimneys. Its location, running down a gable roof, suggests that it was probably a type of step flashing; however, its exact design cannot be determined. The chimneys were reflashed in 1980 with a terne-coated stainless step flashing.

The single large chimney at the south end of the house dates to the ca. 1849 Upjohn remodeling. This chimney combined the flues from the two small chimneys that were originally located on the south side of the ca. 1797 house. Like the pair of chimneys on the north end of the house, each chimney at the south end of the house probably served two fireplaces.

The ca. 1847 engraving of Lindenwald shows a single chimney on the west side of the south end of the roof. Because of physical evidence in the house, the absence of a second chimney is considered an inaccuracy in the drawing rather than evidence that prior to 1849 the south fireplaces were served by only one chimney.

In the 1849 Upjohn rendering, a large chimney is shown on the south side of the house in the location of the present chimney. Its distinguishing characteristics include a water table separating the lower and upper courses of brick, twelve colonettes (possibly intended to be brownstone), and a cornice capping of dentils and corbeled brick. The rendering shows no brownstone ledges as found in the north chimneys. As with the north chimneys there is no photographic or physical evidence that indicates the colonettes and corbeling were ever incorporated into the south chimney construction.

The flues that run into this large chimney provide additional evidence that it dates to the Upjohn work. Flues from fireplaces in five of the rooms in the Upjohn addition--the kitchen, washroom, library, bedroom, and bathroom--run into this chimney. The routes of the complex flue system on the south side of Lindenwald are described in detail in section IV.C.2.

In the earliest photograph of Lindenwald (HP5, ca. 1890) the south chimney straddles the roof's ridge. It consists of a water table separating the upper and lower courses of brick. The top of the chimney has a simple, possibly brownstone cap. The brickwork below the water table appears unpainted; the brickwork above the table is painted a light color, probably the same as the body of the house; the cap appears to be unpainted brownstone.

In a ca. 1910 photograph of Lindenwald from the Frisbee Collection (HP8) the top of the chimney has been altered. The brownstone cap has been removed and replaced by five courses of corbeling. The brickwork of this chimney appears to be unpainted.

The 1936 Weig photograph of this chimney (HP3) shows a chimney similar to the one in the ca. 1910 photograph (HP8). It consists of twelve courses of brick below the bluestone water table, followed by twelve more courses of plain brick and five courses of corbeling. The corbeling is deteriorated significantly--the irregular outline indicates that bricks are missing.

In 1974 this chimney was significantly deteriorated. The stone water table and many mortar joints had been patched with Portland cement. Other mortar joints were severely weathered. When compared with HP23 (taken in 1936), only ten of the twelve courses of brick above the water table were present; all the corbeling was missing. In 1980 the portion of this chimney above the water table was completely rebuilt. The present chimney consists of twelve courses of brick and a bluestone water table. Many of the stones in this water table are reused. Their edges are angled and the gaps between them are filled in with mortar. The similarities between this stone and the water table stones in the north chimneys suggest they were reused from the original pair of

chimneys at the south end of the house. Above the water table are an additional twelve courses of brick and four courses of corbeling with a fifth course simulated by a short metal chimney cap. The size of the brick, the size of the mortar joints, and the mortar mix used to rebuild the chimney are the same as the north chimneys. As rebuilt, this chimney is similar to the chimney shown in the post-1910 photographs.

As with the north chimneys, no physical evidence of the original flashing for the south chimney has been found. The location of the chimney straddling the roof ridge suggests stepped flashing, as is shown in the 1936 Weig report photograph. The type of metal used for the flashing is unknown. During the 1980 rebuilding of the chimney, it was reflashed with terne-coated stainless step flashing.

There are two additional chimneys on the 1849 one-story Upjohn addition. One chimney is above room 118, the other at the gable end of room 112.

The chimney above room 118 serves the fireplaces in this room and in room 011. The chimney has a third flue whose function is unknown. The earliest photographs showing this chimney are from the Weig report (HP27, 28, and 29). In these photographs the chimney is composed of eight courses of brick (counting up from the lowest point of the terneplate roof), a stone water table, three courses of brick, fourth and fifth courses into which brownstone corbels were set--two on the south and north sides and one on the east and west sides--followed by about fourteen more courses of brick. The top of the chimney appears to be corbeled; however, the quality of historical photograph 27 and the branch covering the top of the chimney in historical photograph 29 prevent positive verification.

By 1974 the chimney above room 118 had been completely rebuilt. It consisted of a five- to eight-course brick base straddling the flat and sloping sides of the terneplate roof, a brownstone water table made of stone used previously in ledges, and a straight run of twenty-four courses of brick. The number of brownstone ledges used in the water table is greater than the number that would have been used for its earlier design, suggesting that prior to 1850 the south chimneys might have had ledges. No physical or photographic evidence for such ledges has been found.

In 1978, as part of contractual work on the terneplate roof, this chimney was again rebuilt. Its reconstruction was based on historical photograph 29, as interpreted at the site. It now consists of the five to eight base courses, the water table made of used ledges, three courses of brick, and fourth and fifth courses into which new brownstone ledges are set--two on the north and south sides and one on the east and west sides. The brick in the chimney is approximately the same size as the brick in the chimneys of the ca. 1797 house. Mortar joints are 3/4" wide; the mortar mix is Ironclad Portland.

By 1974 the flashing for this chimney had been coated heavily with roofing cement. Although the flashing was considered to be original, its condition necessitated replacement with terne-coated stainless

steel when the flat roof was reconstructed. This work was part of a 1978 contract. The flashing at the sloping roof junctions remains as originally built and consists of base flashing only.

The chimney at the west end of the gable in room 112, unlike the other Lindenwald chimneys, is not connected to a fireplace. At present, this chimney contains no active flue. A stove pipe hole leading into the chimney in room 112 indicates that it was formerly used with a stove, probably a kitchen cookstove. The evidence found in room 112 and the brick size and color of the chimney all confirm that it dates after the historic period (see the room 112 description, section IV.B.2.i.). The earliest photograph showing it (HP18) has been dated between 1917 and 1925. The chimney does not appear in a photograph dating to ca. 1900 (HP6). Thus, it was built between 1900 and 1925. The first clear photograph (from the 1936 Weig report) shows a small, nearly square chimney consisting of a straight run of approximately sixteen courses of brick topped with four courses of corbeling. It has no water table or brownstone ledges.

By 1978 this chimney had been rebuilt with Portland cement and a brick of an irregular color. The corbeling detail had been eliminated, and it was lined with a modern clay liner. As part of the 1978 ternplate roof contract, this chimney was rebuilt according to its appearance ca. 1920 (see HP14). The flashing for this chimney was also removed in 1978 and replaced with terne-coated stainless.

There are other areas of roof flashing at the intersection of the two buildings. The sloping roof sections have been flashed only with a slight reglet into the masonry. These areas were cleaned and tested for leakage, had bricks replaced and mortar repointed, and were caulked--remaining substantially original and functional. Other flashing along the flat roof and tower was too heavily coated with asphalt and tar compound to be salvaged. The original design was followed, using a new wood cant with 28-gauge terne-coated stainless steel as a base flashing, with a reglet into the masonry. Details are shown on drawing 13 of contract CX-1600-7-0056.

13. Cornices, Gutters, and Leaders

None of the 1797 wood cornices has survived. They were removed when the cornices were rebuilt during the Upjohn remodeling.

The only evidence of a pre-Upjohn cornice is found in the reputed 1847 engraving of Lindenwald. In this engraving the east elevation of the house has a simple cornice consisting of two fascia boards; the upper fascia board overhangs the lower. A balustrade appears to be made from large boards in which decorative openings are cut. The gable ends of the house have a simple molded cornice, the exact configuration of which cannot be determined from the engraving. No gutters or leaders are shown in this engraving.

Surviving elements of the Upjohn wood cornices on the ca. 1797 part of the house include the west dormer soffit and crown molding, the complete cornices for the small east dormers, modillions scattered about the grounds, and some of the wooden outriggers to which the

wooden cornice assembly was attached. These elements confirmed that the 1849 cornices accurately followed the cornices illustrated in the Upjohn rendering and have served as the basis for the reconstructed cornices.

The overhanging cornice on the ca. 1797 part of the house consisted of a crown molding, with capping on the gable slopes and built-in gutters on the level eaves. Modillions were placed under the cornice overhang at approximately 24" intervals on all sides of the house. They were cut to conform to their specific locations.

Downspouts were located at both the north and south ends of the gutter on the east side of the house. In the ca. 1890 photograph of Lindenwald, the downspout at the southeast corner of the house appears to be of circular cross section, 4" in diameter. The run of the downspout is straight, except for the angles below the cornices, the dogleg at the water table, and the angle at the end. The end of the downspout is approximately 6" from the ground, indicating that it was not connected to a dry well. It may have emptied onto a splash block. Several brownstone splash blocks have been found at the site. Two are apparently in their original locations at the north and south ends of the front facade under the ca. 1960 porch. The downspout is painted the same color as the house. It is assumed that this downspout dates to ca. 1849.

In 1974, the majority of the terneplate gutter liners and wood cornice elements remained on the Upjohn addition. Several changes had been made to the cornices and gutters in the 20th century, including the removal of modillions, reinforcement and replacement of the gutter liner in several areas with a larger-sized metal pan, and successive coating of the liner surface with roofing cement. None of the original downspouts were found in place, although pieces were found scattered about the grounds.

Photographic evidence (HP24) indicates that the cornice detail and downspouts on the Upjohn addition were of the same design as those on the ca. 1797 portion of the house, scaled down for the lower smaller building.

Contract work on the Upjohn addition in 1978 and 1979 included study of the gutter system pitch, identification of original elements, reconstruction of the entire wood cornice (and outrigger reinforcement) according to original details, reconstruction of the entire liner using 28-gauge terne-coated carbon steel with a locking strip for securing the original sloping roof terneplate to the new gutter liner, newly designed drip edges, and reconstruction of 3" and 4" diameter downspouts from photographic interpretation and several elbows found on the grounds (see IP016). Specifications, drawings, and completion reports under contracts CX-1600-7-0056 and CX-1600-9-0036 may be consulted for further elaboration.

14. Skylight

The skylight is located in the flat part of the Upjohn terneplate metal roof. It is centered on the arched window opening in the west wall of room 206 and provides light to this room and to the south portion of room 119 (see IP017).

The skylight is a monitor type. Its north, south, and west walls are of post-and-beam construction and contain three fixed sash with six lights in a horizontal row. The east wall of the skylight is formed by the brick west wall of the ca. 1797 house and the window opening in room 206. Later storm sash cover the fixed exterior sash.

The skylight has a hipped roof, covered with its original terneplate roofing and flashing where it joins the ca. 1797 portion of the house. Both the roof terne and the flashing were cleaned and repainted during 1978 contract work.

In 1974 the skylight had a simple cornice consisting of cavetto and cyma recta as bed molding beneath a protecting fascia. Since the profile of the bed molding matches the ca. 1960 crown molding on the main house, this cornice is considered to be a ca. 1960 replacement. When it was removed, paint lines and rafter ends provided the evidence for reconstructing the historic bracketed cornice. A box of small wooden brackets found in the house matched the paint line evidence in shape and numbers. A plain wood base, topped by a cove, surrounds the skylight. This base was covered with terne-coated stainless steel flashing during the 1978 contract work.

15. Walks, Drives, and Related Site Features

These features are addressed in a two-volume "Historic Grounds Report" prepared for the North Atlantic Regional Office, National Park Service (see Stokinger 1981 and Simon 1982).

B. Interior

1. Basement

a. Room 001 - Furnace

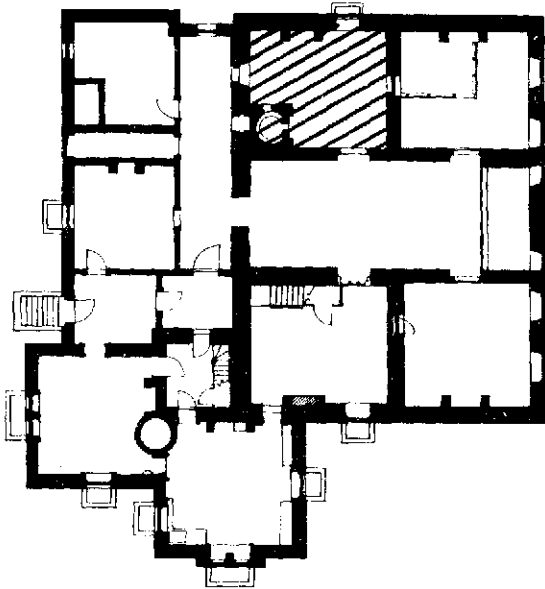

Room 001 occupies the northwest corner of the 1797 house. To the best of our knowledge, there is no documentary or photographic evidence concerning the earliest appearance or uses of this room. The historic hot-air furnace and the modern oil-fired boiler in this room provide eloquent proof of its use from the last years of Van Buren's life to the present. (The furnace is dated to Van Buren's lifetime by the patent date "August 22, 1854" on its cast-iron firebox door and by the inscription on its sheet metal access door, "Hon. M. Van Buren/Kinderhook, N.Y.") See section IV.C.2. for a full description of the historic heating system.

Walls are unpainted stone rubble except for the white-painted brick furnace enclosure in the southwest corner and the unpainted arched brick chimney foundation on the north wall. High on the north wall west of the chimney foundation is an area of loose stonework. Near the base of all walls and especially on the furnace, mortar is powdery or has fallen out of the joints because of "rising damp." The floor is a lime mortar wash, roughly $\frac{1}{2}$ " thick, over sand. In the middle of the room, the lime mortar has been destroyed by moisture and wear. The lime mortar is intact near the walls and extends roughly 10" up the wall surface. The floor level is lower than that of any other room in the 1797 portion of the basement. This level coincides with the bottom of the ash clean-out door of the furnace, and the furnace occupies the full height of the room, so it is assumed that the floor of this room was excavated to accommodate the furnace. (For further discussion of this point, see NPS, Fiero 1983.)

The ceiling consists of exposed handhewn pine joists roughly 6-1/2" by 8-1/2" at an average of 36" on center, running east/west, and vertical sawn tongue-and-groove floorboards running north/south.

Access to room 001 is by door 005 from room 003. The opening is framed by heavy timbers, mortised-and-tenoned and pegged at the corners, and rabbetted to receive the door. Square holes in the frame indicate the locations of wrought-iron pintles on the north (in-) side of the east jamb. A chiseled area on the west jamb indicates the former location of an iron keeper. Door X02, found stored elsewhere in the basement, fits this opening, and the hardware locations match. It is of batten construction with 2'0" wrought-iron strap hinges that have

oval bulges near the socket ends--a common detail in Dutch American culture (Sonn 1928). There is a sheet-iron rim lock, which is described in detail in section VI.D.1. The door also has evidence of an earlier lock and a wrought-iron thumb latch. This evidence suggests that the door dates to ca. 1797. It could not have remained in place after the installation of the furnace, because the main duct to the first and second floors crosses the doorway in such a way that the door could not have been opened. The 1938 floor plan by Victor DeProse shows a door here. Perhaps he was using the evidence of a former door to indicate the original door swing.

Room 001 has four windows (007, 022, 023, and 024). Window 022 has a solid timber, mortise-and-tenon pegged frame, which appears to be a part of the 1797 construction. Window 007 has a box frame fastened with cut nails. Windows 023 and 024 have nailed board frames that have been extended outward during the ca. 1850 construction. Windows 022, 023, and 024 are interior windows and have no sash at present. Evidence of window hardware indicates that window 022 had casement sash at one time. It has always been an interior window sharing light between rooms 001 and 002. Windows 023 and 024 were probably exterior windows until the addition was attached to this part of the house ca. 1850. When the furnace was installed (1854-62), window 024 became the return air inlet. Window 007 is an exterior window in the north wall, east of the chimney foundation. The exterior molding around the frame is different from the moldings around the other two surviving exterior 1797 basement window frames (W003 and 004), and cut lines in both jambs indicate that the original wood sill was replaced. This window also has a set of wrought-iron bars similar to those found on the other 1797 basement windows; however, these bars were fabricated to pivot on a pintle, an eye for which still remains on one end. The sash are twin in-swinging casements hung on surface-mounted loose-pin sheet-iron butt hinges (probably of a later date). The muntins have the distinctive Upjohn profile. The Upjohn sash, brownstone sill, brick framing of the opening (none of the 1797 window openings are framed with brick), and the mortar type all indicate that this window opening was cut through ca. 1850. Because of a rising grade and a deteriorated wood sill, the sill was replaced and a shallow window well built outside the opening using cement for the mortar ca. 1890 (see sketch). Perhaps windows 001, 002, 005, and 006 were treated the same way ca. 1890.

There is a jumble of cast-iron drain pipes in the northeast corner adjacent to the house sewer that penetrates the north wall and leads to a septic tank in the yard north of the house. These pipes were removed in the summer of 1980. Remnants of the bell pull system abound in room 001. The system is discussed in detail in section IV.C.5. The heating system elements, the historic furnace, and modern boiler are discussed in detail in section IV.C.2.

The changes that have occurred in this room include the installation of window 007 (ca. 1849); installation of the furnace and ducts, removal of door 005, and excavation of the floor (dated between 1854 and 1862); installation of modern plumbing (dated to ca. 1920 by the oral account of former owners); installation of an electrical light fixture; and installation of a modern steam-heating system (ca. 1950). The present steam boiler was installed by the National Park Service in 1977.

The preservation and restoration work recommended for room 001 includes the following items:

Remove the boiler and heating system pipes.

Install a new boiler and fan coil unit attached to the historic furnace to circulate air through the restored historic ducts.

Remove the plumbing and patch holes.

Restore the historic floor finish.

Repoint the lower portion of the walls.

Repair and paint the furnace.

Repair window 007.

Restore the bell pull system.

b. Room 002 - Storage

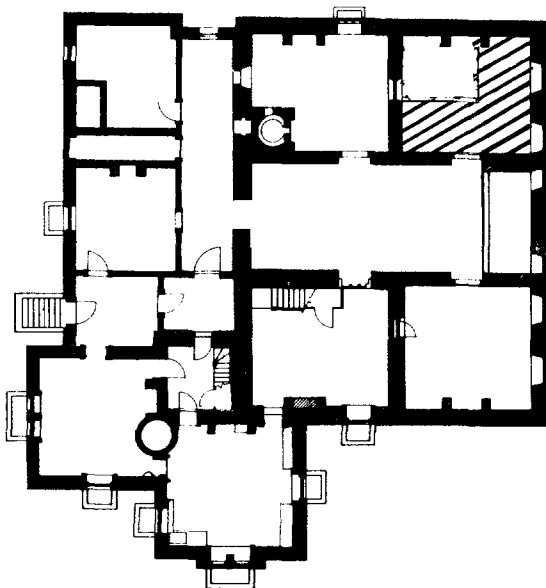

Room 002 occupies the northeast corner of the 1797 house. The northwest corner of this room was separated by a wood stud and board partition creating room 002A (discussed below). No documentary or photographic evidence relating to the historic use and appearance of this room survives. However, wrought-iron hooks in the ceiling, a "cistern" in the floor, and shelves in room 002A suggest that its primary function was food storage of some sort.

The original walls of this room are whitewashed rubble masonry with lime mortar except for the arched chimney foundation on the north wall, which is whitewashed brick, and the whitewashed board-on-studs partition, which separates room 002A from room 002. The boards in this partition are sash-sawn, and they are attached to the studs with cut nails. The plates and some of the studs used in this partition have empty mortises with no associated evidence of missing members, suggesting that they are reused. Because of the way the different materials meet, it is clear that the partition predates both the floor and ceiling finishes.

The floor is a lime mortar wash over sand and cobbles. This floor finish extends 6" to 8" up the masonry walls. There is an unidentified feature in the southeast corner of the floor (see IP018). It consists of a hole (apparently intentional) filled with sand and

cobbles and surrounded at a distance of 6" to 12" by a raised, more or less rectangular rim of lime mortar applied over the floor material (not integral with it). It has been suggested that it might have been used as a cistern or beverage cooler. The 1938 floor plan by DeProsse labels it as a cistern and represents it with a dashed circular outline. The existing evidence does not support such a representation. Perhaps there was a circular tank above the floor, and the hole served as a drain for waste or overflow. But there is no evidence of such a tank or of the pipes that would have led to it. The beverage cooler theory supposes that bottles were laid on their sides within the rim and covered with ice or partially submerged in cold water. The hole would have allowed excess water to drain into the soil under the house. Another possibility is that a beverage cooler was arranged as a tank raised off the floor similar to the cistern described above. For this use, water supply pipes would not have been required.

The ceiling of room 002 is whitewashed, one-coat plaster on circular sawed wood lath. Lath nails are ca. 1850 type, and the plaster analysis shows a strong similarity to other ca. 1850 plaster (see sample M008). Other evidence, to be discussed under room 003, indicates that the ceilings in this part of the basement were installed after the furnace (ca. 1854-62). Above the ceiling are 6" by 8" hewn joists and sash-sawn tongue-and-groove flooring dating to 1797. The ceiling post-dates the construction of the previously mentioned partition because the plaster is a continuous surface butting against the partition with no sign of cutting and patching.

Door 003 connects to room 003, the central hall of the basement, and door 004 connects to room 002A. Door 003 is a 6'3-1/2" by 3'10-1/4" opening in a mortise-and-tenon pegged timber frame with a rabbet on the inside (room 002). On the west inside face of this frame are two square holes indicating the former locations of wrought-iron pintles. On the east face is a wrought-iron staple that engaged the bolt of the 5" by 8" stock lock, which is still present on door X01. This is a 6'4-1/2" by 3'10" board-and-batten door whose surviving hardware matches the staple and pintle holes at door 003. The 1938 basement floor plan by DeProsse shows this door in place and notes the "wooden lock." Door 004 is a 6'1-1/2" by 2'8" board-and-batten door with broken HL hinges and surface-mounted butt hinges. It is assembled with wrought nails. The wrought nails and HL hinges suggest that the door was made earlier than the partition (with cut nails). Although there is no lock present, several keyholes indicate that the door had locks at various times in the past.

Room 002 has two windows (005 and 006) in the east (exterior) wall. These are discussed in the exterior description, section IV.A.10. Wrought-iron bars are mounted on these windows at the interior wall plane. They are attached to the lintels with wrought-iron staples, to the jambs with wrought-iron hooks embedded in the masonry, and to the wall below the sill with a wrought-iron bolt embedded in the masonry.

The only evidence of mechanical systems in this room is a length of modern heating pipe that enters through the east wall of

room 002A, immediately turns south, and exits through door 003. Just north of the door it branches to the east and penetrates the ceiling at the southeast corner of the room.

The major changes that have occurred in this room are the installation of the partition, ceiling, and floor; the alterations to windows 005 and 006; the installation of an electrical light fixture; and the installation of the steam heating pipes. DeProsse family interviews date the installation of the steam heating system to ca. 1950.

The preservation and restoration work recommended for room 002 includes the following items:

- Repoint the walls as necessary.
- Remove the steam-heating pipes.
- Repair the ceiling.
- Repair the partition.
- Replace the doors.
- Repair or reconstruct the windows.
- Whitewash the wall and ceiling surfaces.
- Restore the floor.

c. Room 002A - Storage

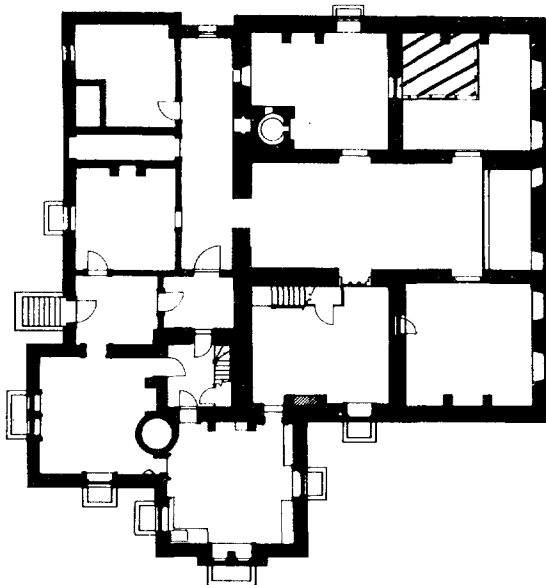

Room 002A is the space that was partitioned off in the northwest corner of room 002. It is apparent from the shelving, the lock evidence on the door, and the jars and bottles still on the floor and shelves that the room was used for food storage.

The walls of room 002A are the same as those of room 002 except that the stone walls are the north and west walls and the board partition forms the south and east walls.

The floor consists of a lime mortar wash over sand and cobbles. The ceiling is also the same as that in room 002. In the

northwest corner of the room, a hole in the plaster, created for the heating pipes, reveals cranks and wires that are part of the historic bell pull system. Door 004 was discussed in conjunction with room 002. The windows in room 002A are windows 022 and 027. Window 022 was

described in conjunction with room 001. Window 027 is simply an area between studs in the board partition that was covered with spaced slats rather than solid boards.

A steam-heating pipe enters room 002A through window 022, passes directly across the room, and exits through a hole in the board partition created by the simple expedient of removing a board. A branch runs parallel to the west wall of the room and penetrates the ceiling at its northwest corner.

The changes in this room are the same as those discussed for room 002. This or room 003A may be the storeroom mentioned by Harriet Butler in a letter of May 17, 1841, to Martin Van Buren: "I am glad to hear from Smith that your store room is made. It will need a good lock and key always in the hands of a trusty person" (Van Buren Papers, CCHS).

The preservation and restoration work recommended for room 002A includes the following items:

Have park curator evaluate the objects in this room for accession into the park collection.

Remove the heating pipes.

Repair elements of the bell system.

Patch the ceiling.

Whitewash the wall and ceiling surfaces.

Repair the shelves.

d. Room 003 - Hall

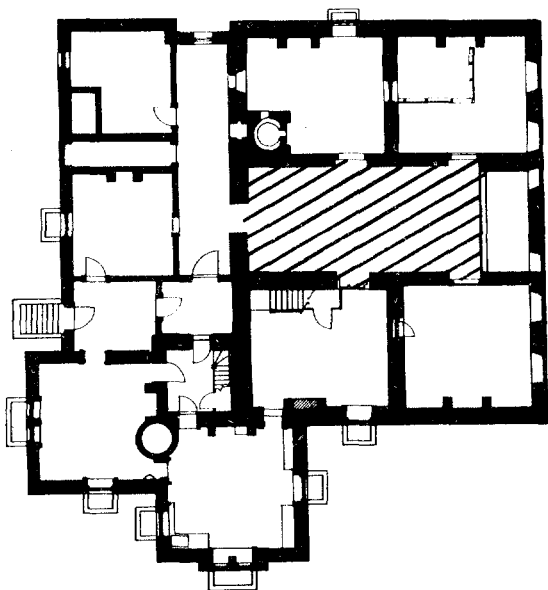

Room 003 is the central hall of the 1797 part of the basement. It provides access to rooms 001, 002, 003A, 004, and (originally but not during the historic period, 1850-62) 005. It is entered from room 012. Access was its primary function, but it may also have been used as a nonsecure storage area.

The north, south, and west walls are rubble masonry, parged and whitewashed. Crumbling mortar and peeling whitewash at the base of these walls indicate a "rising damp" problem. The east wall is a board partition, which was installed before the floor and ceiling finishes because the ends

of the boards are covered with mortar and plaster respectively. The ends of handhewn wood plates, which are embedded in the masonry of the walls between rooms 001 and 002 and between rooms 004 and 005, project from the north and south walls just below ceiling level.

The present floor surface is a very badly deteriorated lime mortar wash over sand and cobbles. The main traffic areas are so badly deteriorated that there is hardly any evidence of the lime surface remaining. At the west entrance to room 003 (D006) there is a brick paved surface 5" below the present floor level. The paving is continuous with the paving in room 012 and may be continuous in room 003 under the present surface. This was not investigated because to do so would have disturbed the present historic floor.

The ceiling of room 003 is a whitewashed one-coat plaster on circular-sawn wood lath with ca. 1850-type cut nails. Four of the handhewn joists that support the floor above are deeper than the others and project below the plaster plane at irregular intervals. Near the southwest corner of the room, there was a stair leading up to room 105. The stair was removed by Van Buren ca. 1840, and no evidence of it survives in room 003 because the opening it occupied has been completely covered with plaster. Evidence for this stair is discussed in more detail in the description of room 105. Near the northwest corner of the room, a framed opening indicates the location where a duct passed through the ceiling to supply hot air to a floor register in room 105. A metal-lined duct opening in the north wall and sheet metal protection of nearby wooden members confirm this observation. The fact that the plaster meets this frame in a continuous layer without patching shows that the ceiling was installed after the furnace. This raises a minor conflict since the ceiling construction is very similar to known ca. 1850 work, but its relationship to the furnace dates it after 1854. There are two possible resolutions for this conflict: (1) later plasterwork was executed in the same manner as ca. 1850 work, or (2) the furnace ducts were actually installed ca. 1850 and the 1854 firebox door was a replacement for an earlier one. A few feet to the east of this opening is a larger one that, according to DeProse family recollections, was the location of a kerosene floor heater. One of the historic floor joists was cut in order to install this heater. A nearby hole in the north wall may have served as passage for a sheet metal flue from this kerosene heater to the chimney in room 001. Ceiling plaster is missing entirely in spots and sagging in many other areas because of broken keys.

Room 003 was historically served by five doors (001, 002, 003, 005, and 006). Doors 003 and 005 have been discussed previously. Door 001 is a 6'3-1/2" by 3'10-3/4" opening framed in the same manner as doors 003 and 005. The door is missing but pintle holes on the west inside (room 004) jamb indicate the direction of swing. A wrought-iron latch keeper is still in place on the east jamb just below a mortise, which once housed the keeper for a rim lock. Door 002 is a 6'4" by 2'7" opening in the board partition. There is no frame as such; the door was hung on H or HL hinges on the room 003 side of the north jamb (simply one of the boards constituting the partition). A 3" sheet metal keeper survives on the south jamb. Door 006, judging by the evidence of reused painted brick found elsewhere in the addition, was shifted northward approximately 2' ca. 1850. The original opening is indicated

by the south jamb and lintel of the original mortise-and-tenon pegged frame, which is still embedded in the masonry. This opening was 3'2-1/2" by 6'6-1/2" (presuming the original floor level to have been the brick paving in this door opening, 5" below the present floor). A wrought-iron pintle survives in the south jamb, room 003 side. The present door opening is 2'4" north of the original one and measures 4'1" by 5'7" (present room 003 floor level to door head). This door is mounted on the room 012 side and will be discussed with that room.

Window 021 opens into room 005. As evidenced by the similarity of the structural frame in this opening to those in doors 001, 003, and 005, this was originally a doorway. The window was created when the walls of room 005 were furred out and plastered. Therefore, this window will be discussed in more detail with room 005. For similar reasons, window 026 will be discussed with room 003A.

Steam-heating pipes run across room 003 between doors 001 and 003, between door 005 and window 021, and between doors 005 and 006. The National Park Service has installed temporary bracing for the floor of room 105 above. It consists of a composite girder of three 2 by 6s spliced with machine bolts and supported on seven jackposts at 4' to 5' centers.

The changes that have occurred in this room include the shifting of door 006; the installation of the board partition; the removal of a stair in the southwest corner; the installation of heating ducts, floor and ceiling finishes, electrical light fixtures, modern plumbing, and modern heating; and structural reinforcement.

The preservation and restoration work recommended for room 003 includes the following items:

Repoint the walls.

Remove the heating pipes.

Restore the heating ducts.

Patch and repair the ceiling.

Restore the floor surface.

Improve structural reinforcement, with better footings and columns.

e. Room 003A - Vegetable Bin

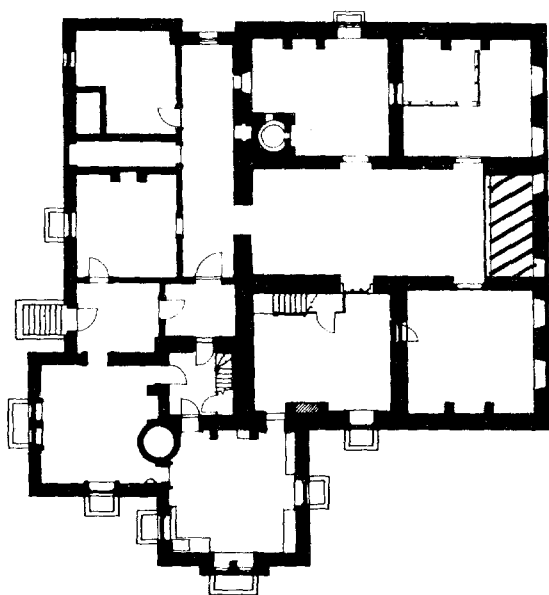

Room 003A is at the east end of room 003. Archeological investigation seems to confirm the tradition that this room was used for vegetable storage. It may be the storeroom mentioned by Harriet Butler in her letter of May 17, 1841: "I am glad to hear from Smith that your store room is made. It will need a good lock and the key always in the hands of a trusty person" (Van Buren Papers, CCHS).

The east and south walls are parged and whitewashed rubble masonry. The north wall is two wythes of brick laid in American bond, with headers every fourth or fifth course, and whitewashed over rubble masonry. The west wall is a board partition nailed to the west sides of a 10" by 6" sill and a 9" by 6" beam (see IP019). Some of the boards are planed square, some are tongue-and-groove, and some are tongue-and-groove and beaded. The beaded boards range from 7" to 10" wide. The square edge and tongue-and-groove boards range from 10" to 11-1/2" wide. This partition was installed after the north and south walls and before the floor and ceiling.

The floor is a well-preserved lime mortar wash covered with dirt and vegetable matter. This is the best preserved section of this type of floor finish and should be used as the model for restoration in other areas. The floor finish butts against the side of the partition sill plate.

The ceiling of room 003A is a one-coat plaster system on circular-sawn wood lath attached with ca. 1850 cut nails. The west side of the ceiling curves down to meet the handhewn beam to which the board partition is nailed.

Door 002 connects this room to room 003. It has already been discussed in conjunction with room 003.

Room 003A has three windows. Windows 003 and 004 are exterior windows in the east wall. They are six-light casements 1'11-1/2" by 2'1-1/2" with 7" by 9" lights and HL hinges that appear to date to the original 1797 construction. The frames are heavy, mortise-and-tenon pegged timber frames with a molded exterior architrave. They probably survived because they were protected by the 1850 front porch. Even so, the frames are now so severely rotted that they will have to be replaced in kind. These windows are covered with wrought-iron bars similar to those on all other exterior windows that date to 1797. Window 026 is a four-light wood sash 1'10-3/8" by 2'1-1/2" with 9" by 11" lights originally intended for use as the upper sash in a

double-hung window (see IP019). The size indicates that its original location was probably window 103, 104, 203, or 205 (the sidelights to the front door and the Palladian window). The sash is now fixed to an opening in the board partition. It seems very likely that it was installed in its present position in ca. 1840 or later because there was major replacement of exterior sash at that time. That may also be the time when the partition itself was created.

One heating pipe runs through the south end of the board partition, along the south wall, and up through the ceiling at the southeast corner to a fin coil unit above.

The major changes that have taken place in this room are the brick veneering on the north wall (which may be original), the installation of the board partition that created the room, the floor and ceiling finishes, the intrusion of the heating pipe, and the removal of door 002.

The preservation and restoration work recommended for room 003A includes the following items:

Remove the dirt and vegetable matter from floor; screen for artifacts.

Remove the heating pipe and patch holes.

Stabilize and repair the ceiling.

Whitewash the walls.

f. Room 004 - Wine Storage

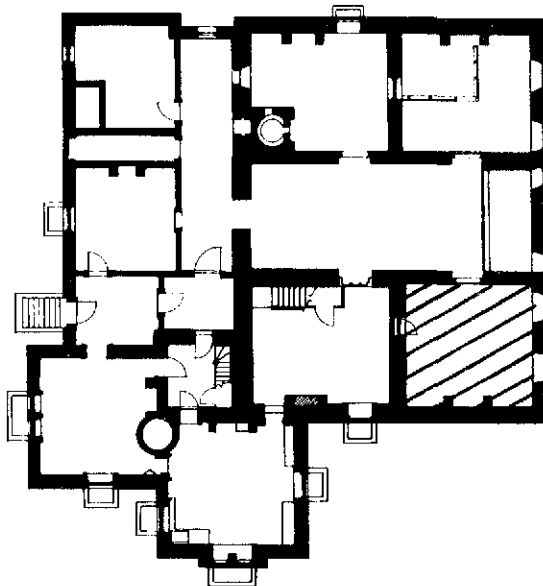

Room 004 occupies the southeast corner of the 1797 basement. The surviving racks and barrels suggest that the room was used for storage of beverages. Evidence below leads to the conclusion that these fixtures are historic.

The walls are whitewashed rubble masonry with heavily mortared joints. The arched brick chimney foundation against the south wall is also whitewashed. Due to "rising damp" or infiltration of rainwater, the mortar at the base of the walls is slightly deteriorated.

The floor of room 004 is a lime mortar wash over sand and cobbles. Except for a small area near door 001, the floor is in good condition.

The ceiling is the familiar whitewashed one-coat plaster on circular-sawn wood lath with ca. 1850 nails that has also been found in rooms 002, 002A, 003, and 003A. Because of broken keys, the plaster is sagging in several areas and totally missing in others.

Door 001 is missing. The opening on the north wall is a 6'3-1/2" by 3'10-3/4" heavy timber frame similar to those on doors 003 and 005. Square holes indicate the former locations of two pintles on the south face of the west jamb. A wrought-iron latch keeper is still in place on the east jamb below the ghost of a rim lock keeper.

Windows 001 and 002 are exterior windows on the east wall (see IP020). They are discussed in the exterior description, section IV.A.10. Wrought-iron bars identical to those in room 002 secure these windows. Window 020, located in the west wall, is a six-light casement 1'11-3/4" by 2'1-3/4" with 7" by 9" lights and HL hinges. It fits in a heavy timber, mortise-and-tenon pegged frame that is integral to the 1797 construction of this wall. Its original function may have been to share light and allow ventilation between rooms 004 and 005. This function was superseded ca. 1850, or before, when the opening was sealed with brick on the room 005 side. See the room 005 description of chronological evidence of this work.

A heating pipe enters the room at about 5' 6" above the floor through door 001, traverses along the north wall, and turns up through the ceiling at the northeast corner. A return pipe descends to near floor level at the northeast corner, traverses the north wall, and exits through door 001 at its sill. Two racks, each 3' by 10', consisting of parallel wooden beams with areas hollowed out of their tops are located against the east and west walls respectively (see IP021). Most of the fourteen original barrels survive, but a few have dried out and shrunk so much that they have fallen apart. The barrels, with their iron hoops and handcrafted wooden staves and heads, are products of the traditional cooper's craft. The appearance of the barrels and the racks is in every way consistent with the historic period. Since the racks appear in the 1938 measured drawings by DeProsse, they cannot be dismissed as part of Kenneth Campbell's collection. Elements of the bell pull system protrude through the ceiling at the west side of the chimney foundation. The way the plaster is applied clearly indicates that the bell pull predates the ceiling.

The changes that have occurred in this room include the installation of the bell pull system, the installation of floor and ceiling finishes, the raising of the sills in windows 001 and 002, the installation of the racks and barrels, the closing of window 020, and the installation of an electrical light fixture and the heating system.

The preservation and restoration work recommended for room 004 includes the following items:

Under the direction of the project supervisor or a historical architect, sort building materials in this room into nonhistoric and historic groups. The historic materials should then be sorted according to those that can be reused and those that cannot. The latter group should be carefully recorded and submitted to the park

curator for accession into the park collection or disposal at the curator's discretion.

Remove the heating pipes.

Repair windows 001 and 002.

Repoint and whitewash the walls.

Restore the ceiling plaster.

Restore the floor finish.

Restore the barrels.

Restore the bell pull system.

g. Room 005 - Servants' Dining and Stair

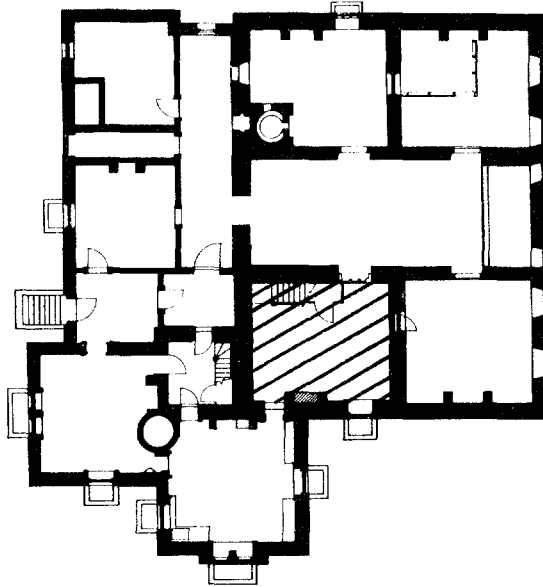

Room 005 is in the southwest corner of the 1797 part of the house. According to tradition, it was used as the servants' dining room during the historic period. The evidence of call bells, the stairs, the wallpaper, and the proximity to the kitchen (room 006) combine to add credence to the tradition.

The walls of room 005 are a two-coat plaster on wood lath attached to furring strips with ca. 1850 nails. Behind the furring strips, the rubble masonry walls are whitewashed. The plaster is covered with a striped floral wallpaper. Analysis of this wallpaper is presented in section VI.C.

A chimney breast or foundation projects into the room at the middle of the south wall. It too is plastered and wallpapered. Because it is covered with historic plaster and wallpaper, it is impossible to determine if the opening was a fireplace or merely another arched chimney foundation similar to those in rooms 001, 002, and 004. In a letter of December 3, 1849, from Smith Thompson Van Buren to Richard Upjohn, the following statement suggests that this chimney breast may have contained a fireplace before the 1849 alterations: "For the accommodation of the glazier a fire was started in the room in the old house under the breakfast room, [this would be room 005] where a fire has been used every winter since the house was occupied by my father" (Upjohn Papers). There is a plugged stovepipe opening in the chimney breast near the ceiling. Its presence suggests that there may have been a flue to this level during the historic period and possibly as part of the original construction. The fact that the firebox in room 109 seems not to

have been disturbed since the installation of the exterior ventilation ducts gives support to the theory that room 005 was served by a flue during the historic period. The reason for the great interest in the possible presence of a fireplace behind the historic wall finish is the mystery of where the kitchen was located before 1850. This is the only plausible location that survives. Most of the evidence supporting this hypothesis is circumstantial: The walls, the ceiling beams, and the underside of the flooring were whitewashed, and it was close to the stair leading from room 003 to room 105. On the other hand, the fireplace opening is smaller than one would expect for a fireplace that was used for cooking for a large household, and there may have been other spaces (demolished ca. 1849) suitable for use as a kitchen. The L-shaped partition that encloses the space under the stair is composed of tongue-and-groove boards with a wood grain painted finish. The typical baseboard for secondary spaces in the Upjohn work (a plain board with a cavetto and no shoe molding) is found on all walls of the room except the board partition under the stairs. Here the baseboard follows the plaster wall behind the partition. Paint samples (P758 and P759) from this partition do not contain the first layers of cream paint found on the other woodwork in this room. However, the absence of wallpaper suggests that the partition predates the wallpaper.

Areas where the historic wallpaper was not applied indicate that a base cabinet surmounted by shelves occupied the northeast corner of the room. The cabinet was 5'11" wide along the east wall and extended up to the ceiling. The base was 1'4" deep and 2'6" high. Shelves were 10-1/2" deep and placed at 3'9-1/2", 4'11-1/4", and 6'0-3/4" above the floor.

The floor consists of random-width (5-1/2" to 8") tongue-and-groove boards, face-nailed to sleepers that are set in a sand-and-cobble bed with lime mortar topping between sleepers. This floor construction was specified by Upjohn: "The floor timbers to be as follows for the wash room, kitchen, lower passages and all other places that is not floored with brick paving to have sleepers of locust cedar or chestnut wood, hewn on the upper side straight and sufficiently smooth to lay a floor well upon them--placed 20 inches from centres--to average 5 inches diameter." The boards run north-south. Two sleepers, already severely rotted, and several floorboards were removed from the northeast corner of this room in 1978 to allow archeological investigations to be conducted.

Access to room 005 is through door 021, which connects to room 006, the historic kitchen, and through door 131 at the top of the stairs in the northwest corner. Before the historic period window 021 was also a door. Door 022 is a batten door that provides access to the storage space under the stair. The stair consists of one riser to a landing in the northwest corner and a run of twelve risers to the east terminating at door 131. This door is described in conjunction with room 108. An irregular-shaped handrail is supported by a massive, turned newel post and slender rectangular balusters, two per tread. Five of the balusters are missing and six others have been severely weakened by insect damage. Two steps lead down to door 021, which no longer hangs in the opening. Hinge and strike mortises indicate that the door hung on the east jamb and swung into room 006. The opening is

trimmed on both sides with typical ca. 1850 architrave molding. However, a close inspection of an area of exposed masonry wall on the room 006 side above this opening indicates that the opening predates 1850. A parge coat on the masonry surface has been carefully finished to form reveals at the head and jambs of an opening. Whether the opening was a door or a window cannot be determined because the pertinent areas of the jambs are concealed behind historic construction. Finding an answer to this academic question does not justify disturbing the historic fabric.

Window 019 is on the south wall east of the chimney breast. It is a segmental-arched double-hung six-over-six window with external iron bars and a window well. All these features plus the muntin and architrave profiles and paint layering are typical of the Upjohn work (ca. 1850). The vertical architraves extend to the floor, and the panel under the window stool is finished with vertical tongue-and-groove boards. There is evidence of an earlier window well, bulkhead, or areaway outside window 019 (NPS, Fiero 1983), but there is no accessible physical evidence that it existed as a window or door before 1850. The archeological evidence may be related to the earlier opening at door 021 as part of an areaway leading to it. Window 021, near the east end of the north wall, was originally a door, similar to doors 001, 003, and 005. All that remains in place is the heavy timber frame. Door X03 may fit this opening; the size is correct and the hardware is mounted on the proper sides of the door, but historic construction prevents fitting the door in place. This doorway was converted to an interior window by inserting a wood frame covered with circular-sawn wood lath and plaster (contemporary with other ca. 1850 plaster in the room) and applying reveal boards and architrave moldings. There is no sash in this opening and no indication that there ever was one. Window 020 was originally an opening in the east wall that provided light and ventilation between rooms 004 and 005. The opening was bricked in on the room 005 side during or before the ca. 1850 plaster installation. The plaster now covers this entire wall without a break or other indication of where the opening was.

Numerous cast-iron drain pipes, copper water supply pipes, heating pipes, and electrical cables traverse the room. There is evidence of call bells on the east and south walls (see section IV.C.5). A row of three or four wrought-iron pipe hangers, driven into a ceiling joist, runs east-west across the room near the south wall and above the plaster ceiling. Whatever pipe they may have held was removed before the ceiling was installed. Perhaps it led to the bathtub that Van Buren mentioned in his letter of November 6, 1846, to Gorham A. Worth (see Van Buren Papers, LOC), or perhaps it led to the feature in the southeast corner of room 002.

Changes to this room include the installation of a stair to room 108, the flooring, plaster, wallpaper, and wood trim, the call bells, the water supply drainage, and heating pipes, and the electrical cables.

The preservation and restoration work recommended for room 005 includes the following items:

Remove the pipes and electrical wiring.

Restore the floor in northeast corner.

Stabilize and repair the plaster walls and ceiling.

Consolidate weak balusters and replace missing ones.

Reproduce wallpaper using original samples in room 108.

Whitewash the ceiling.

Restore elements of the bell pull system.

Paint all woodwork (cream, Munsell 5Y 9/2, Benjamin Moore GB-60).

h. Room 006 - Kitchen

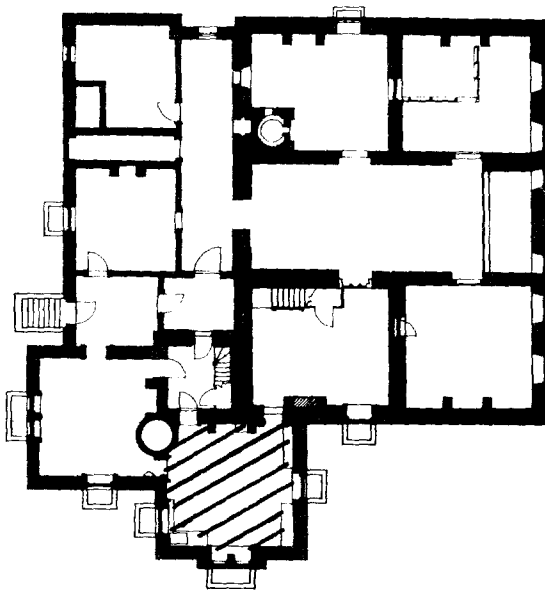

Room 006 is in the south bay of the ca. 1850 addition. It was the kitchen for the Van Buren household during the historic period. The evidence for this use consists of the cast-iron range and ovens in the north wall, the water supply, the cupboards, and the circular brick oven in the northwest corner of the room.

All of the plaster, lath, and furring strips are completely gone from the walls of this room. The exterior walls (east, south, and west) are of coursed rubble masonry with horizontal wood nailers incorporated into the construction for attachment of

vertical furring strips. The jambs of window openings are trimmed with brick. Openings are spanned with wood lintels. A veneer of brick covers the exterior from just below grade to a brownstone water table. The north wall and the circular oven are brick (except for the bottom 2'6" of the oven, which is rubble masonry). Paint evidence from shelving found in room 114 indicates that it came from room 006. Paint samples also indicate that one of the cabinets still in room 006 is original. Pipes and markings on the floor and walls indicate the probable location of a sink in the southwest corner. It was 5'6" by 2'0" by 2'4" high. A stone sink has been found in the house. It measures 4'10-1/2" by 2'0". Because the force pump is known to have been located within the area, this sink cannot have been there. A hole at the upper west corner of the north wall adjacent to the brick oven shows where a pipe chase led from the force pump toward the bathroom.

The floor of room 006 shows several different materials and methods of construction. A strip of floor 5' wide along the

north wall and continuous across the room except for 4' at the east side is paved with large, rectangular slate flagstones. A 4' square in the center of the room is a poured-in-place concrete slab with handprints signed by members of the DeProsse family. Rectangles to the east and west of this slab are constructed of square-edge, butted boards, probably of 20th century origin. Flooring in the south side of the room is tongue-and-groove random-width boards, 5-1/2" to 8-1/2" wide, face-nailed to sleepers set in a sand and cobble bed with a lime mortar topping between the sleepers. This flooring matches that in room 005 and is therefore considered historic. The slate is also probably historic.

All plaster and lath are missing from the ceiling of room 006. This provides an excellent opportunity to observe the structure and deafening of the floor above. Here is the way Upjohn specified the construction: "Floor timbers of the first floor to be 2 in. thick, 12 inches from centres & 12 in deep--or 3 in. thick 14 in. from centres and 12 in deep, hewing have bridging well nailed and fitted to be fixed to all the naked floors--This floor to be deafened perfectly." The joists are actually 3" by 12" on 16" centers. The deafening consists of ledgers nailed to both sides of each joist, with circular-sawn 1" by 6" boards laid on top and butted together loosely. The space between these boards and the underside of the floorboards is filled with bits of mortar, brick, plaster, straw, sawdust, and other construction debris. A small rectangular hole penetrates the ceiling/floor at the extreme southwest corner. It may be related to the water supply system.

An opening 1'2" by 1'6" is 1'11" from the east wall and 2'10" from the north wall. The plaster marks on adjacent joists indicate the opening was made after the ceiling was plastered. The patch in the floor above is larger than the opening and appears to be of recent origin. A 1'11" by 1'2" opening, 9" from the brick oven and 2'10" from the north wall, was patched in a similar manner. A 1'2" square opening in the deafening, 3'8" from the brick oven and 2'10" from the north wall, appears never to have penetrated the floor above. These openings may have contained registers, which would have allowed heat from cooking activities to rise and warm room 111.

Doors 019, 020, and 021 connect room 006 to rooms 008, 007, and 005 respectively. Door 019 is a four-panel door with the standard Upjohn panel molding profile (see section VI.B.). Door 020 is no longer in place. The south jamb has been replaced with a planed board attached with wire nails. The north jamb is concealed behind a similar board used to support a temporary brace that carries the brick arch above. Door 021 was discussed in conjunction with room 005.

The windows in room 006 are 015, 016, 017, and 018. Windows 016 and 017 are paired in a projecting bay on the south side. Both are double-hung four-over-four sash with segmental-arched tops. The base of the bay is occupied by a storage cabinet whose top serves as a large window seat. Window 015 on the west wall and window 018 on the east wall are double-hung eight-over-eight sash with segmental-arched tops. All of this millwork has Upjohn-type moldings, including architraves that extend to the floor, and is considered historic.

Systems represented in this room include the modern hot-water heating pipes, modern electrical wiring, historic water supply and drainage, historic cast-iron range and ovens, and historic brick bake oven. The heating pipes traverse the perimeter of the room from door 020 to door 021, with risers above each window. The primary electrical service panel and supply entry are in the cabinet in the northeast corner of the room. The panel is actually a collection of separate fuse and circuit breaker boxes surrounded by a confusing and unsafe tangle of wires. There is a convenience outlet on this panel and a single bare bulb with pull cord in the center of the room. The cooking equipment is discussed in section IV.C.2. The historic water system is discussed in section IV.C.3.

The major changes that have occurred in room 006 are the abandonment of the brick bake oven, the insertion of the Moses Pond Union range in the large fireplace opening, the removal of the historic water system, the insertion and subsequent abandonment of a stove pipe opening above the fireplace, the installation of the electrical system, the installation of the heating pipes, and changes to the storage cabinets.

The preservation and restoration work recommended for room 006 includes the following items:

Repair and restore the wood flooring.

Repoint the masonry.

Repair the masonry at door 020.

Restore the plaster ceiling.

Paint all woodwork (tan, Munsell 10YR 8/2, Benjamin Moore CB-35).

Remove the modern pipes and electrical equipment.

Treat the cast-iron cooking range and ovens to reduce the rate of deterioration.

Preserve other aspects of the room "as is."

If plaster is replaced on walls, design to allow ventilation of the cavity between the plaster and masonry wall.

Return the shelving in room 114 to room 006.

i. Room 007 - Laundry

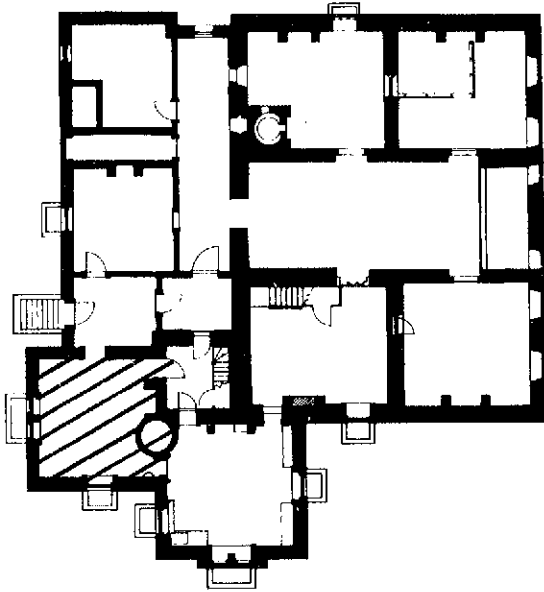

Room 007 is in the southwest corner of the ca. 1850 addition. It was apparently the "wash room" referred to in Upjohn's specification for basement floors. This hypothesis is drawn from the survival of a hand pump and lead-lined wood sink on the south wall of the room. Also the uses of the other rooms in the ca. 1850 portion of the basement have already been determined, or the rooms do not have the water supply required for a washroom.

The south, west, and north walls of room 007 are coursed rubble masonry with built-in wood nailers for the attachment of furring strips. The east wall is brick

with a two-coat plaster applied directly. Furring strips, lath, and plaster are missing from the exterior walls except in the upper portion of the northwest corner. The north and east walls retain most of their plaster except near the floor where "rising damp" has caused it to deteriorate into a powder or to lose its bond with the brick work and spall off in sheets. There is no surviving evidence of baseboards in this room. At the center of the east wall is a large fireplace and chimney breast adjacent to the cylindrical brick bake oven (see IP022). The fireplace opening is approximately 2'6" square with perpendicular reveals and a cast-iron fireback. The opening was originally 1'4" higher than at present. Two soldier courses of brick laid in a pseudo-arch on top of an iron strap served to reduce the opening height. The fact that the plaster wall finish turns under the original lintel to form a soffit above the later two courses of brick proves that this work was done at a later time, probably before 1862. There was long correspondence between Smith Thompson Van Buren and Richard Upjohn concerning the smoking of this fireplace, the one in the bedroom above, and the one in the bathroom. This correspondence indicates that alterations were made to this fireplace during 1850 construction work to correct this problem. Lowering the opening probably solved the smoke problem.

In the south wall of this firebox, above the level of the lowered lintel, is a cast-iron frame and a door with sunburst patterns at its corners. This door originally led into the bake oven, but the opening has been bricked in. Smith Thompson Van Buren's letter to Richard Upjohn of December 3, 1849, spoke of smoke from a fire in the washroom fireplace entering the kitchen through the oven door. The cast-iron ovens could not have been the culprits because those ovens were completely sealed off from the flues. The offending door must have been the opening on the room 006 side of the cylindrical brick oven, which is now bricked in and shows no trace of ever having had a door. So, obviously the brick bake oven was present in 1850, but it was probably bricked in and appeared much as it does today except that the

brick was plastered. A 2"-thick plank mantelshelf above the fireplace in room 007 is supported on copper-clad iron rods, similar to those used for grounding lightning rod systems, driven into the chimney breast. This appears to be a nonhistoric alteration, but the evidence is inconclusive.

The floor of room 007 consists of 10-1/2" tongue-and-groove boards face-nailed to sleepers. The sleepers are laid in a sand and cobble bed topped with lime mortar. A hearth of slate flagstones extends 3'9" out from the chimney breast and from the north wall to a point about 3' from the south wall. A strip of flooring, probably tongue-and-groove boards on sleepers, is missing along the south wall. This is the area where the sink and pump are located. As in room 006, the flooring in the sink area has rotted away.

The ceiling was a whitewashed two-coat plaster on circular-sawn wood lath. Most of the lath is still in place, but only two small areas of plaster remain near the east wall. There are two stovepipe holes in the ceiling/floor structure approximately on the central east/west axis and 2' and 6' west of the chimney breast respectively. There are only two pieces of chronological evidence pertaining to these openings: They were cut into the plaster after it was installed; and the patches are fastened with wire nails and therefore were probably made after 1890. This tells us absolutely nothing about whether or not stove pipes were present before 1862.

Door 013 leads to room 009, door 017 to room 008, and door 020 to room 006. The last doorway has already been described in conjunction with room 006. Door 013 is missing and its west jamb is severely rotted. A large section of the west jamb roughly 1' wide and 5' high is missing. The opening is 2'9" by 6'10-1/2", trimmed with typical ca. 1850 moldings. The door originally hung on the west jamb and opened into room 009. There are several abandoned and patched hinge mortises, but the jamb is too deteriorated to derive any useful information from them. The foundation does not extend under this doorway. Door 017 is in the east wall of the room at the north end. It is 2'6-1/2" by 6'9-1/2" with four panels. At the top of each of the two upper panels, a glass light has been installed. They are held in place by the panel moldings and rest in a rabbet in the top of the wooden panels. The moldings are attached with L-head cut nails. All evidence leads to the conclusion that the glass lights are original to the fabrication of the door. To insert the lights after the doors were complete would require removing three sections of panel molding, cutting the rabbet, and replacing the molding for each light. This is much more work than to incorporate the lights initially, but if one is determined to retrofit, it could be done. The door is framed with typical ca. 1850 moldings. It is hung on the south jamb and swings into room 008. This door is in good condition.

Windows 012 and 013 are typical ca. 1850 windows: paired four-over-four double-hung sash with segmental-arched tops and typical moldings. Window 014 is the other typical ca. 1850 basement window: eight-over-eight double-hung, with a segmental-arched top. The vertical architraves of these windows extend to the floor like those in rooms 005 and 006; however, the panels under the stools are missing.

A lead pipe enters the room from the south wall between window 014 and the southwest corner and leads directly to a cast-iron hand pump. An inscription in raised cast-iron letters reads "Downes & Co., Seneca Falls, No. 3." The base of this pump is still attached to a board that fit onto the wooden frame of a lead-lined sink. The sink measures 2'7" wide by 1'10-1/2" deep by 2'5" high. The height is approximate because the bottom of the upright board end is rotted to such an extent that the finished bottom does not survive. The integral lead drainpipe is still attached to the lead lining of the sink. By fitting the pipe into the surviving drain opening in the south wall, the original location of the sink can be determined. The sink is smaller than one would expect to find in the laundry for a large household. Perhaps there was another sink in the room, evidence of which does not survive. In room 009 is evidence of a cast-iron drain that led from room 007 to the "cesspool" in room 009. Its path in room 007 has not been traced because the historic floor is still in place. It seems to lead toward the fireplace. The fireplace could have been used for heating wash water, or there might have been a hot-water heater near the fireplace with a stove pipe leading to the chimney breast. In either case, there would probably have been a drain to carry off waste or overflow water. There is no evidence of a hole in the historic flooring for a drainpipe.

There is a pivot for bell pull wires on the north wall. It is about 1' west of door 013. One of the wires passed through the north wall, the other ran eastward along the north wall through two staples to a point just east of door 013, where its path can no longer be traced. No further evidence of this branch of the bell pull system has been discovered. One can only suppose that it might be related to the branch that led from room 001 to room 012 and could not be traced farther.

There are several pumps and water tanks stored in this room. None are attached to any piping, so their association, if any, with the historic period of the house is very tenuous. The following is a list of those pumps and tanks:

Hand pump with spout
W. & B. Douglas
Midd'n, Conn.
No. 4

Hand pump with spout
W. & B. Douglas
Midd'n, Conn.
No. 3

Patented July 1, 1870 (therefore definitely nonhistoric). A cone and plunger/pump handle assembly with patent date of 1862 seem to fit this pump body, but the appearance cannot be considered conclusive proof.

Force pump mounted on a shaped plank (see IP023)
W. & B. Douglas
Midd'n, Conn.
No. 3
Patented July 1, 1862.

The plank is 4'7-1/2" high x 9-3/4" wide, the handle projects 6-1/2", overall thickness is 1'0" with a painted wood-grain finish similar to other grained finishes in the basement. A flanged connection at the bottom of the pump seems to fit the supply pipe in the southwest corner of room 006, the kitchen. A comparison of the patent date with the date of Van Buren's death (July 24, 1862) makes it highly improbable that this pump was installed during Van Buren's lifetime. Considering the time required for notification of the patent award, fabrication of molds, and fabrication and delivery of the pump itself, it is virtually impossible that this pump was installed while Van Buren was alive.

Water heater
Gould Manufacturing Co.
Sentinel - 1910
Seneca Falls, N.Y.

Water heater
Montgomery Ward & Co.
#1125 F
Maximum working pressure - 125 lbs.
(T)ested to 300 lbs.
Hydrostatic pressure
A.S.M.E.
Standard

Hand pump with spout
Storral Co. #29
Medina, New York

Pump top with handle
Bears patent date of 1842

There is also a modern water pump with an attached pressure tank and a modern electric water heater. Both of these pieces of equipment are in the southwest quadrant of the room. Heating pipes pass through doors 013 and 020 with a right angle turn above window 014.

The major changes that have occurred in this room are lowering of the fireplace opening; installation of stovepipes and/or through-the-floor vents; a sequence of changes to pumps and water heaters; installation of a mantelshelf, heating pipes, and electrical lighting; and deterioration and subsequent removal of plaster from walls and ceiling and flooring from the south end of the room.

The preservation and restoration work recommended for room 007 includes the following items:

Remove the nonhistoric plumbing and wiring.

Restore the flooring.

Restore the plaster and whitewash.

Restore the "laundry sink and pump."

Restore elements of the bell system.

Restore all woodwork to a cream color (Munsell 5Y 9/2, Benjamin Moore GB-60).

j. Room 008 - Stair Hall

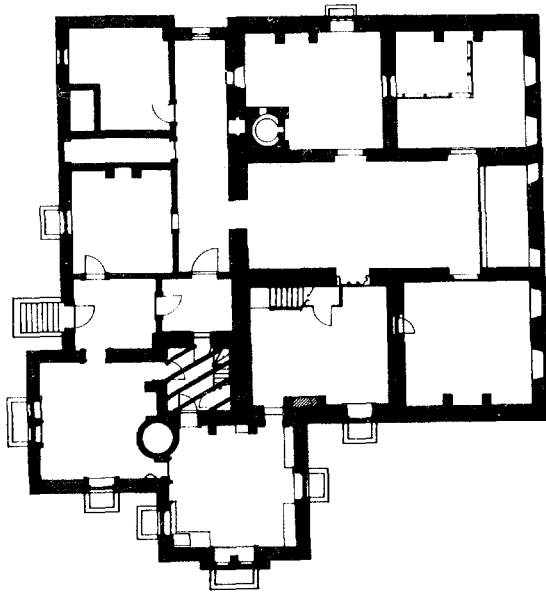

Room 008 is the lowest level of the tower stair and the primary interior access to the basement. The walls of the room are whitewashed, two-coat plaster directly on masonry walls. The north and east walls are rubble stone construction; the south and west walls are brick. Aside from minor damage to the south wall (caused by rising damp) and to the northwest corner (probably caused by leaking pipes), the plaster and masonry are in good condition. The east wall under the stair consists of a board partition with a board-and-batten door, both of which have a painted wood-grain finish. The underside of the stair and the

east and south walls behind this board partition are finished with plaster and whitewash. Typical ca. 1850 baseboard for secondary spaces is found in the main part of the room and around the south and east walls under the stair, but not on the board partition. Thus, this partition is considered nonhistoric, as are similar partitions in room 005 and between rooms 113 and 117.

The stair along the east wall contains 14 risers leading to the first floor. The first three treads are winders at the northeast corner, then a straight run of six treads to a landing at the southeast corner and three more treads to the first floor. The balustrade consists of a rectangular handrail with a torus and curved top surface and a bead at the lower edge, two turned balusters for each tread, and a massive, turned newel post with a square base. The bottom 14" of the newel post is a separate and smaller square block of wood to which the post is toenailed. The handrail terminates in a circular cap on top of the newel post. The balusters and newel post have collars at the top and midpoint and a tuscan base. The baluster bases are turned. The lower stairs are not properly supported because the bottoms of the supporting members have rotted.

The floor is random width tongue-and-groove boards face-nailed to sleepers. This floor has not been disturbed. It is assumed the sleepers are laid in a sand and cobble bed, topped with a lime mortar as in the other basement rooms of the Upjohn addition.

The ceiling is a whitewashed two-coat plaster on circular-sawn wood lath. It is in good condition except for a small area near the stair opening where the plaster is missing and a strip along the west wall where a wooden pipe chase ran historically and electrical wires run now. The pipe chase is described in section IV.C.3.

There are four doors in room 008. Doors 017 and 019 have been described in conjunction with rooms 007 and 006 respectively. Door 016 has two lights at the top of its upper panels and is in other ways similar to door 017. It is on the north wall of the room, hangs on the west jamb, and swings into room 008. It has the cast-iron Norfolk-type thumb latch that is considered typical of ca. 1850 doors in secondary spaces. The hinges are the typical five-knuckle eight-hole cast-iron butts. A less-worn area on the floor under this door indicates the former location of a wooden threshold strip. There are several other thresholds in this area that could serve as models for a replacement. Door 018 is a 3'4-1/4" by 2'4-1/2" board-and-batten door that provides access to the area under the stairs. It consists of three vertical boards and two battens and hangs on a pair of two-knuckle six-hole cast-iron butt hinges. It is an integral part of the wood-grained board partition that is thought to be nonhistoric.

Room 008 has no windows except the glass lights in doors 016 and 017 discussed previously.

The only systems in evidence here are the historic pipe chase along the top of the west wall, the modern electrical, telephone, and intrusion/fire detection wires that currently occupy that space, and a ceramic pull-chain light fixture in the middle of the ceiling.

The major changes that have occurred in this room are the addition of the board partition, the removal of the pipes and pipe chase, and the addition of electrical, telephone, and alarm wiring.

The preservation and restoration work recommended for room 008 includes the following items:

Reinforce the lower steps by adding pressure-treated wood seals to historic supports.

Remove the nonhistoric, unsafe, and unnecessary wiring.

Repair the plaster and whitewash.

Restore the pipe chase.

Refinish the floor (need additional research to determine historic finish).

Remove the nonhistoric board partition.

Restore all woodwork to a cream color (Munsell 5Y 9/2, Benjamin Moore GB-60).

k. Room 009 - Basement Entry

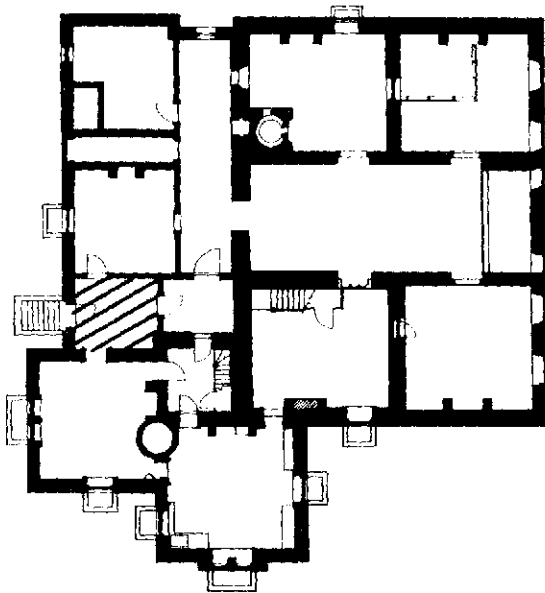

Room 009 is a vestibule/entry space. Door 012 in the west wall of the room gives access to the bulkhead stair. The historic cesspool is under the floor of this room. There is also evidence that suggests the brick platform in the southeast corner may have supported a water heater.

The walls are masonry covered with two-coat plaster and light gray whitewash. The south and west walls are coursed rubble stonework, and the east and north walls are brick. At the southeast corner the stone foundation of the tower projects into the room. On the south wall just west of the tower foundation

are a stove pipe hole and a soot stain. Plaster is completely missing from the west wall and the west ends of the north and south walls. The eastern portions of the north and south walls are missing plaster below 4' from the floor. The south end of the east wall has only a small area of plaster remaining near the ceiling. Plaster is still present at its north end. In the northeast corner two boards with wrought-iron pipe hangers, cut nails, and lead strips are the only remains of a vertical pipe chase that connected to a horizontal pipe chase that traversed the eastern 7' of the top of the north wall. The chase is no longer present, but its "ghost" marks and two wedge-shaped supports survive. The chase appears to have carried the drain pipe for the bathtub in room 114.

Very little remains of the historic floor in room 009. Along the west wall, at door 012, is a section of large rectangular flagstones. In the southeast corner is a small rectangle of brick flooring two courses thick on top of large stones. The historic plumbing section of this report (IV.C.3.) suggests that this platform may have supported a water heater. The proximity to the stove pipe opening tends to confirm this hypothesis. The remainder of the floor area was dirt when the house was acquired by the National Park Service. A single fragment of wood sleeper set in mortar was found in the northeast corner of the room, suggesting that this room had the same type of floor as the other basement rooms in the Upjohn addition. The major feature in the floor is the cesspool. It is a stone-lined cavity approximately 5' deep by 4' inside diameter. It is constructed of small flat stones of irregular shape laid in mortar. Three drains lead into this feature and one leads away from it. A drain pipe from the bathtub in room 114 appears to have fed into it from the northeast. A lead drain pipe from the water closet in room 115 leads into the cesspool from the southeast, and a large iron pipe (approximately 8" in diameter) leads into it from the south. The path of this iron pipe has not been traced because it is covered by historic flooring in room 007. From the northwest side of the cesspool a brick drain covered with an iron plate leads under door 011, turns due north,

and crosses under the floor of room 011. This entire system is described and analyzed in section IV.C.3.

The ceiling of room 009 was probably covered with a two-coat plaster and whitewashed like the walls. The historic plaster has been replaced by a thin brown coat of modern plaster. The circular-sawn lath is still in place on the wood joists.

Room 009 is served by four doors, one on each wall. Door 001 on the north wall provides the only access to room 011. It is a 6'9-3/4" by 2'8-1/2" four-panel door in the ca. 1850 style with small glass lights at the tops of its upper panels similar to those in doors 016 and 017. It is surrounded by the standard double-cavetto architrave typical of ca. 1850 work. It hangs on the west jamb and swings into room 011. Its lock stile was cut through and one glass light was removed to allow the heating pipe to pass through. A mortise lock with brass face plate is still present, but the knobs are missing. The threshold of this door is not supported by a foundation, but it rests (rested) on rubble backfill over the previously mentioned brick drain. Door 012 is the exterior door that leads to the bulkhead stair. It was described in section IV.A.11. Door 013 is on the south wall and leads to room 009; it has already been described in conjunction with that room. Door 014 is on the east wall and leads to room 010. It is a 5'10-1/2" by 2'8-3/4" four-panel ca. 1850 style door with the typical cast-iron butt hinges and a cast-iron Norfolk-type thumb latch. It hangs on the north jamb and swings into room 010. The reason that the door is so short is that the floor of room 010 is 11" above the floors of rooms 008 and 009. Architraves on both sides are the typical double cavetto of ca. 1850 work. This door, too, has no foundation.

Room 009 has no windows except for the two small lights at the top of door 011.

The evidence of the plumbing system in this room has been outlined in the descriptions for rooms 114, 115, and 116 and in Section IV.C.3. Modern communications and electrical wiring enter the room through a hole in the north wall and fan out to various destinations including a ceramic pull-chain light fixture in the middle of the ceiling and a hole in the ceiling near the southeast corner to run a telephone cable to room 114. A heating pipe passes directly through doors 011 and 013.

The preservation and restoration work recommended for room 009 includes the following items:

Fill the cesspool with sand to prevent its collapse.

Place a piece of date-stamped sheet metal on top of the fill.

Replace the flagstone on top of the cesspool where found by archeologists; if needed elsewhere for floor restoration, simply continue the sand fill and restore the tongue-and-groove flooring on preservative treated wood sleepers.

Remove the heating pipes and electrical and communications wires.

Repair the doors.

Restore the plaster on the walls and ceiling.

Restore the pipe chases.

Restore all woodwork to a cream color (Munsell 5Y 9/2, Benjamin Moore GB-60).

I. Room 010 - Transitional Space

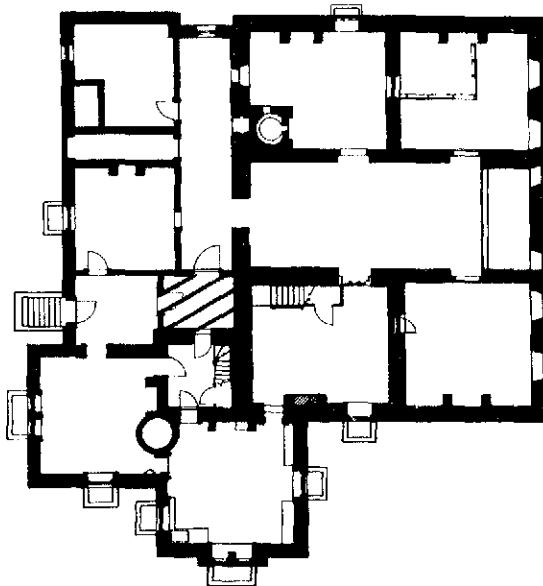

Room 010 is east of room 009 and north of room 008. It is a small rectangular space 10' by 7'6" whose only apparent use is as a transitional space between rooms 008, 009, and 012.

The walls are covered with a two-coat plaster and whitewash. Except for minor cracks, a large area of missing plaster in the southwest corner, and a small area of missing plaster near the floor in the northwest corner, the plaster is in good condition. In the east wall there are two straight vertical cracks, extending from floor to ceiling, indicating an infilled door. The north jamb of this door was about

1' from the north wall of this room and virtually collinear with the north wall of room 005. The opening would have led directly to the landing of the present stair in room 005, a location where there is now (and was historically) a landing one step above the level of the floor in room 005. The question of what this opening was like, where it led, and the nature of related features is academic because the plaster on the room 010 side and the furring, lath, plaster, stair, and other woodwork on the room 005 side are all ca. 1850 work. The east wall is the west wall of the 1797 portion of the house and is of rubble stone construction. The south wall, the tower foundation, is of coursed rubble construction. The west and north walls are the usual brick construction of ca. 1850 basement interior walls. In all cases the plaster is applied directly to masonry.

The floor of the room is face-nailed tongue-and-groove boards of random width running in an east-west direction. The subfloor construction was not investigated because it would have caused damage to the historic floor, which is intact. Based on the similarity of surface appearance to other basement floors, it is assumed to rest on sleepers laid in a sand and cobble bed with lime mortar topping between the sleepers.

The ceiling is a two-coat plaster with whitewash on circular-sawn lath. Only a small area of plaster at the northeast corner survives in place.

Room 010 is served by three doors, 014, 015, and 016. Doors 014 and 016 were discussed in conjunction with the other rooms they serve--rooms 009 and 008 respectively. Door 015 is a four-panel door with the typical Upjohn molding. It is 5'10" x 3'9-3/4", hangs on 4" x 4" cast-iron butt hinges on the east jamb, and swings into room 012. Its extreme width is a mystery, because other doors between it and the exterior are at least a foot narrower. It has a cast-iron thumb latch on the south side; the staple is broken and the latch bar is missing from the north side. One of several cast-iron plates that have been used to mend the door is marked "Oak Hill Mfg. Co. #2 Oak Hill N.Y." All the doors in this room are framed with the standard double-cove architrave found in secondary spaces of the ca. 1850 addition.

Room 010 has no windows except the two glass lights in the top of door 016.

In the southwest corner of room 010 the three pipes that ran from room 006 through room 008 turned and ran up into the water supply tank above the water closet in room 115. All three pipes are extant in this room. The soil pipe from the water closet also ran down the southeast corner of this room. Remnants of the pipe are extant at ceiling height. A vertical board nailed into the plaster walls of the corner and a 3" hole in the floor indicate the route of the soil pipe to the cesspool. The wooden chase, however, continued across the west wall, and a hole in the northwest corner connected it to the chase in the northeast corner of room 009. A variety of electrical wires cross the ceiling of this room and are attached to it by staples.

The only changes in this room since its creation, ca. 1850, appear to be the removal of parts of the pipe chase and some of the pipes and the installation of electrical wiring.

The preservation and restoration work recommended for room 010 includes the following items:

- Remove the electrical wires.

- Repair and patch the plaster; whitewash.

- Rebuild the pipe chases.

- Restore all woodwork to a cream color (Munsell 5Y 9/2, Benjamin Moore, GB-60).

m. Room 011 - Chamber

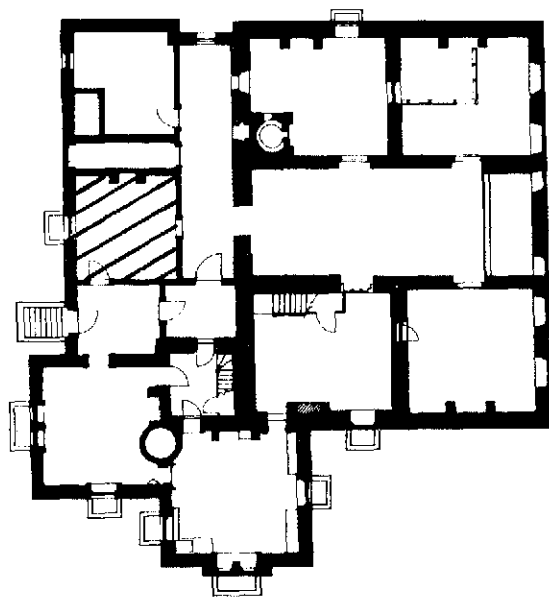

Room 011 is along the west wall of the ca. 1850 portion of the basement, just north of room 009. There is no documentary evidence of its use, but the presence of a fireplace suggests that it was used for human habitation--possibly a servants' bedroom.

The walls of room 011 were covered with a whitewashed two-coat plaster. Plaster was applied directly to the brick on the north, east, and south walls and to wood lath over furring strips attached to wood nailers that were incorporated into the construction of the coursed rubble stone west wall. Plaster, lath, and furring strips are all

missing from the west wall. No plaster survives on the north wall. Plaster is missing from the lower 4' of the south wall and from the lower 2' of the east wall. A hole was created in the east wall, north of window 025 for the passage of heating pipes. A chimney breast with fireplace projects from the center of the north wall. It contains several underfired ("salmon") bricks, which are powdery and eroded. Heating pipes pass through a hole created for that purpose in the center of the chimney breast about 6' above the floor. There is no baseboard or cornice in this room.

The floor consists of random-width tongue-and-groove boards laid in a north-south direction on squared wooden sleepers in a sand and cobble bed with lime mortar topping. A 5'- to 6'-wide strip of flooring along the west wall of the room was seriously deteriorated when the house was acquired by the National Park Service. During the 1978 archeological investigation, this area was excavated initially to reveal the footing for the west wall and later expanded to trace the brick drain from the cesspool. The excavation has been left open to assist in drying out the west wall of this room. Unfortunately, access to the area could not be prohibited, and the brick drain was damaged by careless visitors or staff. The excavation has now been backfilled. Floorboards have been removed from an area about 3' wide to the east of the excavation, but the remaining floorboards are in fair condition.

The ceiling of room 011 was covered with a whitewashed two-coat plaster on circular-sawn wood lath attached to the undersides of wood joists. Most of the lath is still in place, but all the plaster is missing.

Door 011 provides access from room 009 to room 011. The door has already been described in conjunction with room 009, but it should be reiterated that the west architrave has been replaced with a plain board and the threshold rests on an unstable sandy fill.

Room 011 has two windows: 011 on the west wall, and 025 on the east wall. Window 011 is a 4'4-3/4" by 3'2-3/4" eight-over-eight segmental-arched double-hung window. The lower sash appears to be a replacement because the muntin profile and the sash lock differ from those found on other windows of ca. 1850. Both vertical architrave pieces are missing. They probably extended to the floor like those in room 006. The lower part of both jambs have been pushed out into the room by the movement of the adjacent masonry. The movement was probably caused by freeze-thaw action and consequent collapse of the window well. The window stool and any apron that may have existed are now missing. The stonework in the window stool area has been parged with what appears to be a Portland cement mortar. A bundle of telephone wires and a large telephone panel box are attached to the south jamb. Window 025 is a 4'8" by 2'3-3/4" rectangular opening arranged for vertical sliding sash but containing no sash or pulleys. Differential accumulations of dirt in the sash tracks indicate that sash were present for an extended period. The window has the usual ca. 1850 architrave, sash stop, and stool moldings. The unusual feature of this window is its location on the east wall of room 011, an interior wall shared with room 012. It was probably installed to provide a little more daylight for room 012 and more direct cross ventilation for room 011 and the basement in general.

Two hot-water heating pipes enter room 011 through a hole in the east wall north of window 025. One pipe makes a 90 degree turn to the north and passes through the center of the chimney breast. The other continues west and turns south before reaching the west wall. It passes through the middle of door 011, which has a horizontal slot cut in it so that the door will continue to swing even with the pipe passing through it. Electrical wires lead from the hole in the chimney breast to a white porcelain pull-chain fixture in the center of the ceiling. Seven telephone cables connect to the panel box on the south jamb of window 011. Two run north and five run south. The fireplace shows very little evidence of use. The only area of soot is on the three bottom courses of brick. This suggests that either the room was not occupied on many winter nights or the furnace and other heat sources provided sufficient warmth.

The major changes that have occurred in room 011 include removal of sash from window 025, deterioration and removal of plaster, installation of heating, electrical, and telephone systems, deterioration and removal of floorboards, and disturbance of the soil and flooring because of archeological excavations.

The only conservation problem associated with this room is the rising damp that has caused deterioration of floorboards and plaster. Because proper rainwater drainage has been installed, it is anticipated that the dampness will subside.

The preservation and restoration work recommended for room 011 includes the following items:

Remove the heating pipes, telephone, and electrical wires.

Continue to monitor the dampness on the west wall.

Restore the subfloor and floor surface along the west wall.

Restore the threshold of door 011.

Repair the holes made for utility lines.

Repair and replace the plaster; whitewash.

Restore all woodwork to a cream color (Munsell 5Y 9/2, Benjamin Moore GB-60).

n. Room 012 - Back Hall

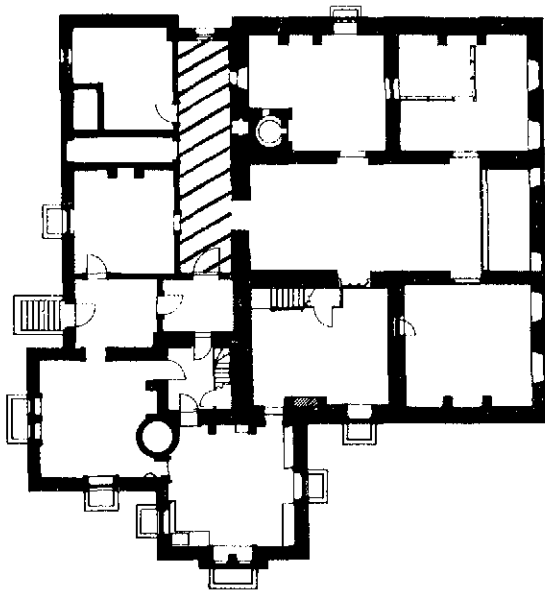

Room 012 is the back hall of the basement. It provides access from room 010 to rooms 003, 013, and 015. In recent years (and possibly earlier) it has been used as a storage area.

The south and west walls of room 012 are of brick construction with two-coat plaster applied directly to the brick. The plaster on the south wall is in good condition. On the west wall, plaster has deteriorated to a greater or lesser extent because of rising damp of variable intensity. The north wall is of coursed rubble stone construction similar to that of other exterior walls built ca. 1849. There is no evidence to

indicate whether this wall was plastered historically. No plaster remains on the wall, and there is no evidence of nailers or furring strips. It has one layer of paint (sample 765), but that cannot be dated. The east wall is of rubble stone construction similar to that in other areas in the ca. 1797 foundation. It is covered with a two-coat plaster surface applied to circular-sawn wood lath on vertical furring strips. Lath nails and the continuity of the plaster at the southeast corner indicate that the plaster work dates to the ca. 1849 construction of the addition. The whitewash on the stone wall under this plaster indicates that this area was exposed, either as a basement or areaway, before the ca. 1849 addition. The plaster on the east wall varies in condition from good at the south end to entirely missing on the north end. All the plaster walls were whitewashed. A hole was created in the west wall for the passage of heating pipes. This is the same hole discussed in room 011.

The floor of room 012 is of two different types of construction. The south end of the room, up to a line just north of door 006, has tongue-and-groove flooring of random-width boards. The subfloor construction cannot be determined because removal of the historic floor would damage the boards, which are in good condition. The north part of the room has a lime mortar wash over brick paving. The mortar wash is similar to that in rooms 001, 002, 003, and 004 and is therefore

considered historic. Because most of it is covered by the mortar wash, it is impossible to determine if the brick paving was ever the finished floor surface of this area (that is, whether it might predate the construction of the addition).

The ceiling consists of whitewashed two-coat plaster on circular-sawn wood lath attached with cut nails to the undersides of floor joists. These construction materials and the continuity of the ceiling plaster with the walls indicate that the ceiling plaster is part of the ca. 1849 construction work.

There are four doors in room 012. Doors 006 and 015 have been described in conjunction with rooms 003 and 010 respectively. Door 007 leads to room 013. The door itself is missing, but the architrave is the familiar double-cove profile found on other openings in secondary spaces of the ca. 1849 work. The historic door hung on surface-mounted butt hinges on the north jamb and opened into room 013. A dimension lumber frame has been applied over this architrave on the room 012 side. It is about 4" wider and 7" higher (3'0" by 6'5-1/2" versus 2'8" by 5'10-1/2") than the original opening. A 7" step down into room 013 accounts for the low height of the original doorway. This frame shows evidence of two sets of hinges, but the door is missing. It is possible that the original door was rehung on this frame, that there were two doors at this opening simultaneously, or that the inner door was removed and replaced with a different one on the outer frame. The two-door possibility would be appropriate for the hypothetical cold food storage use of room 013. There are white stains around the nailheads in the lower portion of the door frame. The stains are probably the result of water (from rising damp) combining with natural acids in the wood and corroding the nails. Door 008 provides access from room 012 to room 015. It is a 2'8-1/2" by 6'5-1/2" six-panel door with panel molding and bead similar to those found on ca. 1797 doors in the major first-floor rooms. The ghost of a former 4-1/2" by 6" rimlock tends to confirm the theory of this door's reuse, but there is no evidence of earlier hinges. A paint sample taken from this door contains only one layer of cream paint. This evidence may have been destroyed by cutting down the hanging stile to fit the door to this opening. The handle and thumb lever are all that remain of a cast-iron thumblatch similar to those on other ca. 1849 doors. The architrave is the standard double-cove profile found in most secondary spaces of the ca. 1849 addition. Two pulleys and a weight pocket attached to the south jamb are the remains of an early automatic door closing arrangement. It is considered to be early because the brass screw pulley is identical to one illustrated on page 63 of the 1865 catalog of the Russell and Erwin Manufacturing Company. The door closer suggests that the people who used this door were often encumbered. However, the direction of the door swing (toward room 015) suggests that heavy loads were carried to room 015 rather than from it as our hypothesis of its use for fuel storage would indicate. The floor of room 015 is approximately 7" lower than the floor of room 012. Thus, the door that was reused in this opening could not have been cut down enough to swing toward room 012. Apparently it was decided to reuse the door even though doing so made it swing the wrong direction for travel with heavy loads. No evidence of devices that would consume large quantities of material has been found in room 015. On the other hand, quantities of

coal and a bricked-in opening that may have been an exterior coal chute have been found in that room. The historic furnace is in room 001. The same white stain found around nailheads on door 007 is present on door 008 as well.

Room 012 has four windows or former windows. Window 025 was described in conjunction with room 011, and window 008 was described in the section on the house exterior (IV.A.10.). It swings on steel butt hinges attached to the top with modern wood screws, and it is secured at the bottom with a simple thumb turn. A wire hook and eye are attached to the ceiling and sash respectively to hold the sash open. The sash and frame are assembled from standard modern dimension lumber (2 x 4 frame is 1-5/8" thick) with wire nails. This is overwhelming evidence that the present window is nonhistoric, but there is no evidence regarding the possibility of a window in this location during the historic period. Windows 023 and 024 are virtually identical, 1'9" by 2'0" openings in the east wall of room 012 leading to room 001. The primary window frames were described in conjunction with room 001. On the room 012 side, 1-1/2"-thick planed boards were added to extend the frame through the furred-out plaster (applied ca. 1849). No trim was applied to these frames.

Heating pipes traverse room 012 from door 006 through the wall north of window 025 and through window 023 to door 008. Electrical wires crisscross the ceiling along paths too numerous to itemize. One ceramic pull-chain light fixture is attached to the top of the north architrave of door 006. A bell pull wire passed through the east wall above window 023, but its path through room 012 cannot be traced.

The changes apparent in this room include deterioration of plaster, installation of heating pipes, and electrical wiring.

The preservation and restoration work recommended for room 012 includes the following items:

- Remove the heating pipes and electrical wires.

- Restore the plaster on the ceiling and east wall; whitewash (for fire safety).

- Restore the floor finishes.

- Restore all woodwork to a cream color (Munsell 5Y 9/2, Benjamin Moore GB-60).

o. Room 013 - Vaulted Tunnel

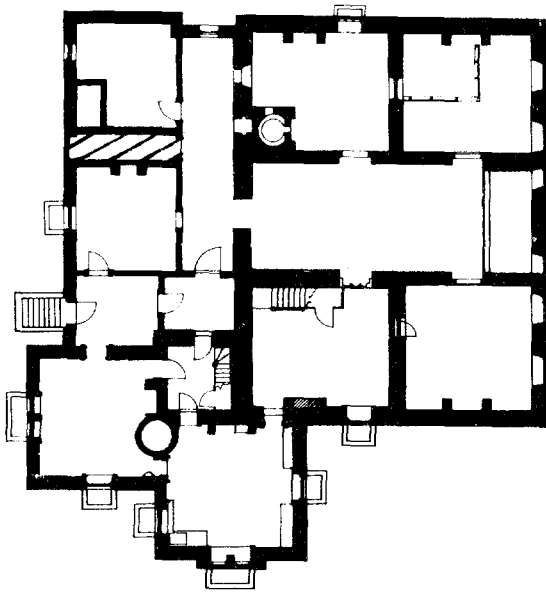

Room 013 is a long, narrow room, 3'6" by 14'6", between rooms 011 and 015 (see IP024). It is bounded on the east by room 012 and on the west by the exterior foundation wall. Its historic and subsequent uses are a subject of considerable interest. The most plausible hypothesis is that this room and an adjacent small chamber to the west were used for cold food storage and ice storage respectively. The evidence supporting this hypothesis is presented in the following paragraphs.

The north and south walls of room 013 are of solid brick construction, three wythes (13") thick (compared to two wythes for adjacent walls). There is no structural reason for greater thickness, suggesting that insulation may have been the object of the thicker walls. The bond used in the brick work is American bond, with header courses at spacings ranging from three to six courses. There is no plaster on the walls and no evidence that there ever was. The end walls are completely dominated by door openings.

The floor is an irregular sand and cobble surface that slopes down to the west. There is no indication of any other floor finish, and no reason to believe that this floor is not historic.

The ceiling is in two vaulted sections, the western half about 1' lower than the eastern half. The change in elevation corresponds roughly to the location of the stairs in the first floor above. The vaults are segmental with a span of 3'6" and a rise of about 6". There is no evidence that the ceiling was ever plastered.

Door 007 was described in conjunction with room 012. The possibility that this opening contained two doors with an air space between lends credence to the hypothesis that room 013 was used for cold storage of foodstuffs. Door 010 is a brick-trimmed opening in the exterior masonry wall that has been filled in with large stones for the lower 2' and brick for the remainder of the segmental-arched opening (see IP009 and IP024). The small room on the other side of door 010 is discussed in great detail in the "Archeological Data Section" (NPS, Fiero 1983). It was a 3'0" by 3'0" by 6'11" room with brick walls, a brick vaulted ceiling, and a native sand floor. It has not been determined whether the ceiling was a full vault or a half vault. The surviving first course of voussoirs on the west wall is laid at an angle that can only be interpreted as the springing of a segmental vault, but the juncture of the vault with the east wall (outside basement foundation) has not been identified. The sand floor of this room is another piece of evidence that

supports the hypothesis of this room's use as an ice storage place. The sand floor would allow icemelt to trickle through and eventually find its way to groundwater. The three brick walls surrounded by earth would provide excellent insulation, especially after the earth was "tempered" by the presence of ice over a period of several months.

Room 013 has no windows.

A modern heating pipe and two telephone cables pass through the room in a north-south direction just east of the change in height of the ceiling.

It is recommended that this room be preserved as is. If the room is to be interpreted to the public, door 010 should be opened and the room beyond should be reconstructed.

p. Room 014 - Privy Pit

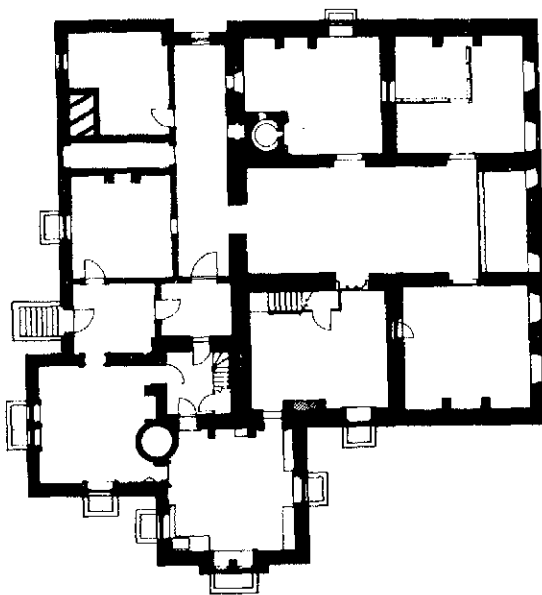

Room 014 is not really a room at all. It is the interim repository for human wastes from room 121 pending their ultimate disposal in another place. It is along the west wall of the basement, adjacent to room 013 and seemingly carved out of the southwest corner of room 015. Interior dimensions are approximately 3'6" by 6'0". Its proximity to the ice and food storage areas seems unsanitary, but as demonstrated by the presence of the cesspool in room 009, either sanitation was not well understood by the architect and owner or it was not a matter of great concern.

The north, east, and south walls are of solid brick construction with a badly constructed stone lining that has partially collapsed and appears to be unstable. The west wall is the coursed rubble stone construction typical of ca. 1849 exterior foundation walls. The lower portion of the interior walls is covered with fill, which was partially excavated by Denver Service Center archeologists in the summer of 1978 (see NPS, Fiero 1983). A portion of the north wall either collapsed or was taken down. The resulting 3' radius hole is roughly the shape of a quadrant, with its center at the intersection of the floor of room 015 and the west wall.

The floor of room 014 was not exposed by the archeologists even though the excavation went 3' lower than the floor of room 015. The ceiling is simply the underside of the wooden privy bench in room 121 and the joists that support it.

Door 009 is in the west wall of the room. The opening is approximately 2' high and 5' wide, spanned by a segmental arch consisting of bricks laid in alternating pattern of two rowlocks and one soldier. The fill in this opening was loose brick and stone rubble (from the partial collapse of the arch) in a sand and earth matrix. The sill of the opening is coursed rubble stonework, at the level of the floor in room 015, and at the spring line of the arch.

There are no windows in room 014.

The historic systems represented in room 014 are for waste disposal. The National Park Service recently installed a metal conduit, junction box, and plastic sheathed cable that comprise the service entrance for the telephone system.

The changes that have occurred in room 014 include the cessation of its use, apparent cleanout and backfill, partial collapse of lining and cleanout arch, collapse or destruction of part of the north wall, and insertion of the telephone system.

The preservation and restoration work recommended for room 014 includes the following items:

Brace and shore up unstable elements.

Complete archeological investigations.

Restore the collapsed masonry.

Remove the telephone system.

q. Room 015 - Coal Storage

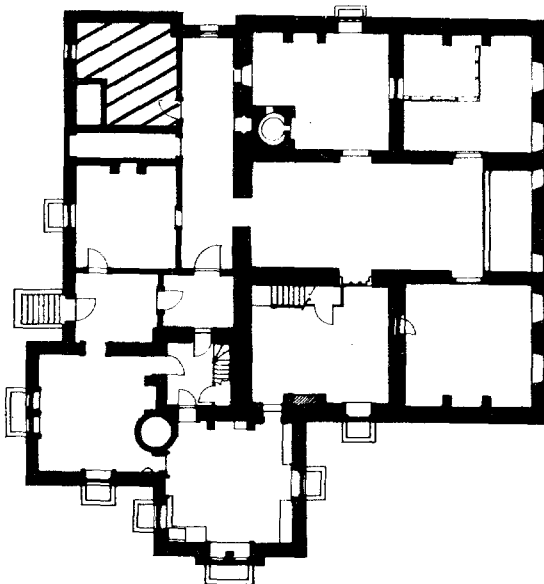

Room 015 is at the northwest corner of the ca. 1850 addition to Lindenwald. The remaining piles of coal in the room, the bricked-in opening on the north wall (which appears to have been a coal chute), and its proximity to room 001 suggest that this room may have been used for coal storage during the historic period.

The exterior (north and west) walls are of coursed rubble stone construction. The interior walls (east, south, and the walls at the southwest corner shared with room 014) are of irregular American bond brick construction. The walls show no evidence of

ever having been plastered or painted. Approximately 20 percent of the bricks are painted, but the absence of paint on adjacent bricks and

mortar suggests that the painted bricks were reused from another structure or from the demolished portions of the ca. 1797 house.

The floor of room 015 is paved with brick, and areas of the brick are covered with a lime mortar wash approximately 1/2" thick. The broken edges of this wash and the dispersed locations of the surviving areas suggest that at one time the entire floor was covered with this material. The floor is 7" to 8" lower than the floor in room 012.

The ceiling consists of exposed wood joists, 3" by 11-3/4" at 16" on center. The full depth of the joists is not exposed to view because of the "deafening" of the first floor. The deafening consists of ledgers attached to the sides of the joists, boards that rest on the ledgers, and a fill of miscellaneous construction debris, mortar, plaster, brick bats, sawdust, etc.

Door 008 has been discussed in conjunction with room 012.

Windows 009 (possible coal chute) and 010 have been discussed in the description of the exterior (section IV.A.10.). There is another window-like opening high on the east wall of room 015. It measures approximately 1' high and 2' wide. The jamb bricks appear to have been cut to create the opening, into which a wooden frame was inserted and then mortared in place. The frame does not survive, but the mortar retains the wood grain pattern. The present sill is a neatly troweled mortar wash. There is no head or lintel to the opening at present, and no evidence of a former head or lintel. This suggests that the window was added after the ca. 1850 addition was completed, but there is no way to determine whether it was installed before or after 1862.

The systems represented in room 015 include the hot-water heating pipes, telephone cables and panel, electrical wiring, and a porcelain pull-chain light fixture in addition to the original fuel storage junction.

The changes to this room include the installation of all the above systems, addition of window 010, closure of window 009, and addition of the opening in the east wall near its north end.

The preservation and restoration work recommended for room 015 includes the following items:

Remove the heating pipes.

Remove the electrical wiring.

Remove the telephone cables.

Remove window 010 and fill with brick and stone to match exterior and interior respectively.

2. First Floor

a. Room 101 - Bedroom

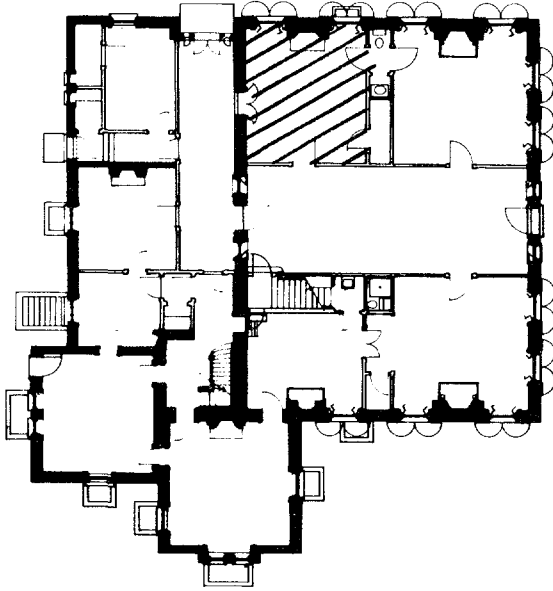

Room 101 is in the northwest corner of the 1797 house. Direct access is from the 1797 central hall, room 105, on the south wall (D101). Door 104 at the north end of the east wall opens into a small closet, room 102, and allows one to pass into the northeast room 104. Originally room 102 was connected to a larger closet, room 103. A door opening in the west wall has functioned as a closet since 1849 (D105). The north wall has a central chimney breast and windows (W109, 110) at either side.

The 1970 Lindenwald Master Plan includes a first-floor plan designating room 101 as a dining room. No documentation has yet been found to substantiate this claim, beyond the 1938 measured drawings by DeProsse.

The available documentation and physical evidence for the 1841 period only suggests that this room was used as a bedroom. In a letter to Harriet Butler dated May 15, 1841, Martin Van Buren refers to a room "downstairs" that is "the best Bed Room" (Downs Collection). Responding to Van Buren's request for wallpaper selections, Harriet Butler writes, "I sent up . . . two kinds of paper for the lower bedroom--one at \$1 for a piece the other 10/ that at a dollar, one of the firm thought would be the best & said he would stand between me and harm" (Van Buren Papers, CCHS).

The surviving fireboard has a scenic wallpaper as its lowest layer, with a border also used in a second-floor bedroom, room 205. These papers have been dated to ca. 1840 and represent the entire physical evidence for wallpaper types (see section VI.C.2.). A process of elimination for designating room uses on the first floor of the 1797 house leaves the two north rooms, 104 and 101, as potential first-floor bedrooms (see descriptions below of rooms 105, 106, and 109 for use documentation). Analysis based on the fireboard evidence does suggest that a wallpaper border appropriate for a bedroom on the second floor would also be appropriate for a first-floor bedroom. A ca. 1930 photograph of room 101 confirms its use as a bedroom during the DeProsse residence (MAVA File (B), photograph L-4, Rowles Studio, DP Collection). With this reasoning and unless proven otherwise, room 101 is recommended for restoration to a bedroom of the Van Buren period, indeed, "the best Bed Room" (letter of May 15, 1841, Martin Van Buren to Harriet Butler, Downs Collection).

Several minor changes have been made in this room. The most recent alteration was made when a door opening was cut

through the south end of the east wall. This alteration transformed a large, rectangular closet (room 102) and a small closet (room 103) into a toilet and sink room (room 103) and a smaller closet (room 102) with access from room 101 rather than from its original room 103 access.

The evidence for this door insertion included a door casing of different molding; construction with wire nails; 20th century hardware; three to four paint layers; a reused wood lintel member with earlier lath marks taken from the 1797 stud framing member, which was cut to accommodate the door opening; and the interruption of a 1797 horizontal pegboard on the closet side of the same wall. Removal of this door casing in January 1980 exposed the 1797 plate with studs tenoned into it. The need for this door opening appears to be directly related to the toilet and sink installation ca. 1920, which closed off the original access. The use of wire nails for this alteration, the oral history related to the building, and the inclusion of this door opening on the 1938 DeProsse drawing date this change to the DeProsse residency, pre-1938.

A second area that has changed is the closet at the midpoint of the west wall (see IP025). Although the height is less than the usual 1797 door height, the paint layers of the inner jamb paneling match the paint layers on other 1797 room elements, and the masonry flat arch, jambs, and infill, which is temporarily exposed on the room 119 side, confirm that the opening dates to 1797. This opening was originally an exterior door, possibly leading to a porch. The masonry infill on the room 119 side (see section VI.F.) and the finishes of room 119 indicate that the passageway was transformed into a closet in 1849, when the Upjohn addition was built.* The vertical board backing, double doors, and pegboard of the closet all show a different paint sequence with fewer paint layers than the jamb paneling itself. The stile member for the jamb paneling was partially removed when the brick infill was put in place. The door casing molding of the closet does not match other moldings in the house (see section VI.B.); its hardware, however, is consistent with other Upjohn hardwares--a cast-iron rim lock dated to 1843-51 (see section VI.D.1.c.).

In addition to the two changes in door locations on the east and west walls, changes were also made in the fireplace masonry. No bonding exists between the rear walls and reveals of the firebox, and the masonry appears to rest upon the inner hearth bricks. The reduction in size of the firebox is similar to work in rooms 104, 106, 109, and 209. Evidence in rooms 104 and 106 dates these alterations to the early 1840s work of Martin Van Buren; the similar work in room 101 may also be considered part of the ca. 1840 changes.

Van Buren, as in other 1797 rooms, also removed the chair rail in room 101. Its location is evidenced by plaster infill and irregularity. This change is assigned to Van Buren work of the early 1840s because of conclusive evidence found in rooms 105 and 109. Van Buren, in ca. 1854, installed a floor register for hot-air heat in the southwest corner. A stovepipe hole also was cut in the chimney breast, probably after the historic period.

*The 1938 DeProsse drawing inaccurately shows an opening in the masonry.

With the exception of the several minor alterations described, this room appears today in its original 1797 form and with its original materials.

The finishes in this room are less decorative than rooms 105, 104, and 106, and as such it may be described as a secondary space with less formality and public visitation. Most of the details either match or are very similar to those found in room 109. Rooms 109 and 101 occupy the rear or west portion of the house on opposite sides of the central hall.

Paint analysis, moldings, and hardware date doors 104 and 107 and their casings to ca. 1797. Other woodwork in room 101 that dates to ca. 1797 includes the window casings, wainscoting, baseboards, and mantel piece. Door 105, a closet door in the west wall, and door 106, a closet door in the east wall, represent exceptions in the consistency of molding types and detailing found in this room. The molding of door 105, although a double architrave with an ogee (cyma reversa) curve and beads, has a shallower profile than the 1797 molding found on all the other casings. The doors of this opening are double doors, each with two panels and applied moldings. Paint dates the door casing to ca. 1797 and the doors to ca. 1849 (see section VI.C.1., paint samples 139 and 141). The hardware on door 105--two-knuckle, cast-iron butt hinges, and a cast-iron rim lock--has also been dated to ca. 1849.

The plaster cornice is the same as the cornices in rooms 104 and 109. The frieze and astragal molding in room 104 is not present in room 101. The cornice design in this room is simpler than the design used in rooms 105 and 106 (see section VI.B.).

A mechanical bell system included a bell crank on the east side of the fireplace with a connection to room 005, the servants' dining room. Physical evidence and the functioning of this system is described in section IV.C.5.

The wood floor is laid in a north-south direction of 4" to 9" random widths, and has one paint layer. The same gray paint found on the floors in rooms 109, 201, and 206 may be dated to the ca. 1940 (nursing home) period. With this evidence and the absence of a gray layer in the west wall closet chromochronology, this paint may also be dated to ca. 1940.

The following preservation and restoration work is recommended to return room 101 to a bedroom:

Remove the radiators and furnace flue pipe.

Review the fireplace masonry (to be done by the project architect).

Reconstruct the plaster wall at the east wall door opening.

Install a period or reproduction hot-air register in southwest corner.

Make miscellaneous plaster repairs, including plumbing and stovepipe hole patching.

Repair window shutters and replace hardware for all pulls, several butt hinges, and sash locks; repair jamb stops.

Restore all woodwork to a cream color (Munsell 5Y 9/2, Benjamin Moore GB-60).

Hang the same reproduction wallpaper and border in this room as in room 205; remove later layers of wallpaper on the fireboard and restore the original scenic panel and border.

Remove paint from the wood floor, excluding the west wall closet floor and review for carpet and/or grass matting tack holes (to be done by the project architect).

Install a bell system wire and reproduction crank on the east side of the fireplace.

Restore the ceiling using a calcimine finish.

b. Room 102 - Bathroom

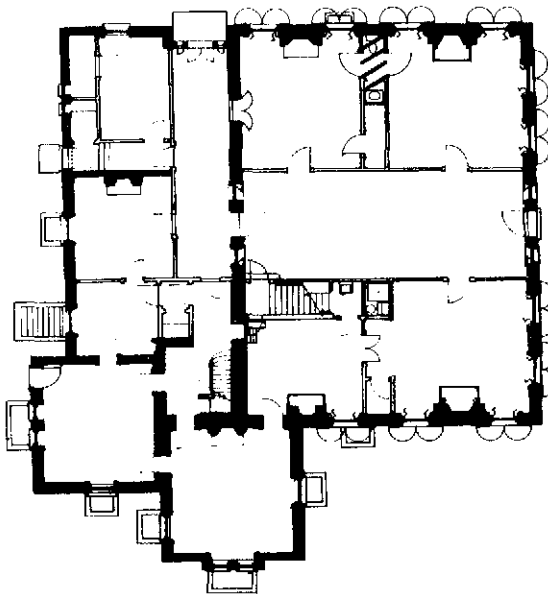

Room 102 is a small space between the two north rooms of the 1797 house. The space is formed by two parallel walls dating to 1797 that run in a north-south direction between rooms 101 and 104. A larger space, room 103, shares this enclosure south of room 102.

Room 102 may be entered from rooms 101 (D104) and 104 (D103). A third door opening (137) exists at the south end of the space.

The transformation of this space into a bathroom occurred ca. 1920. The 1938 DeProsse drawing shows the toilet but not the sink. The drawing also shows removal of the south door and

construction of a short partition wall to enlarge the closet. The 1936 Weig report (NPS, Weig 1936) and the oral history of the DeProsse family do indicate that toilet facilities were installed ca. 1920. In this instance, the 1938 drawing may be regarded as a record of existing conditions.

The door and door casings match those of rooms 101 and 104 and are typical for the 1797 period.

The preservation and restoration work recommended for room 102 includes the following items:

Remove the toilet, sink, and all pipes.

Remove the board partition behind the existing sink.

Remove the later floor coverings and possibly remove the original wood floor.

Reconstruct the north area baseboards to match those in room 103.

Restore the brown coat of plaster on three walls extending to the door casing height in the north area.

Review the exposed areas (to be done by the project architect).

Patch the wood floor and plaster.

Reconstruct the west wall, including framing and plaster work.

Infill the pegboard.

Clean all wood baseboards, to be left unpainted.

Restore the plaster wall finish to a whitewash.

Hang the appropriate door in the north opening.

Restore the ceiling using whitewash.

Restore the north wall door and casing to a cream color (Munsell 5Y 9/2).

c. Room 103 - Closet

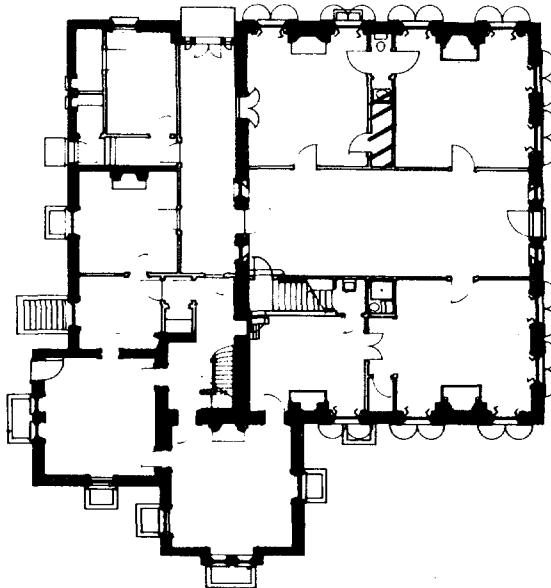

This room is a companion closet to room 102. It is a larger space that was originally constructed with its door opening on the south of room 102. Markings on the east wall indicate that it was originally lined with shelves. The shelves were 9'7" long, 7'4" high, and 1'½" wide and were placed approximately 1'5" apart. On the west wall there was a pegboard set into the plaster brown coat.

This space was altered sometime during the DeProse residency to accommodate modern plumbing fixtures. The north end of this closet was converted into a sink alcove using a board partition to

close off the remaining closet area. A new access was added on the east wall of room 101 by removing one wood stud member and a portion of the

plate (D106). Part of the 1797 stud was reused in the door opening lintel position. This alteration required the removal of a portion of a 1797 pegboard.

Other changes in this closet include ca. 1854 openings in the plaster for hot-air ducts in the south and east walls and the ceiling, for plumbing work, and for the removal of the shelving on the east wall.

Baseboards in room 103 are plain, unpainted boards, 3/4" thick and 4-1/2" high, applied over the plaster.

The following preservation and restoration work is recommended to restore this closet:

Remove the north end sink alcove partition.

Remove the shelving at the south end.

Remove all wallpaper, under the supervision of the MAVA curator.

Review the exposed areas (to be done by the project architect).

Patch holes in the plaster.

Reconstruct the west wall, including framing and plaster work.

Infill pegboard.

Clean all wood baseboards; do not paint.

Restore the plaster wall and ceiling finish to a whitewash.

Hang the appropriate door in the north opening.

Restore the north wall door and casing to a cream color (Munsel 5Y 9/2).

d. Room 104 - Parlor

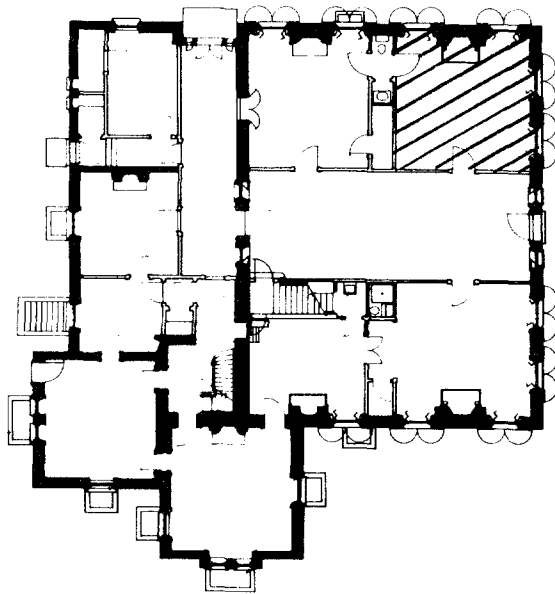

This room occupies the northeast corner of the 1797 house. It is entered from the central hall, room 105 (D102), and also has access to closets 102 and 103 and through to room 101. The east (front) wall has two window openings (W105, 106), and the north wall has a central chimney breast flanked by window openings (W107, 108).

No documentary evidence has been found that clarifies the name or function of this room. However, as one of three rooms, including the central hall (room 105) and the southeast parlor (room 106), that share the most decorative woodwork, its use may reasonably be connected with the formal reception of guests and visitors.

Alterations to this room began during Van Buren's residency and were limited to the fireplace, plaster wall finishes, and the hot-air heating system.

The indications of change at the chimney breast include a horizontal nailer (flush with the plaster wall) above the existing mantelpiece,* ghosts of green lining wallpaper,** and baseboards with exposed end grain where the wood butts against the mantelpiece. Removal of the east baseboard confirmed the suspected change. This baseboard consists of a 1797 section composed of three parts and an 1841 reproduction composed of four, very different parts (see section VI.B.). Paint layers on the different sections of baseboards also indicate that the fireplace alteration occurred in 1841 (see section VI.C.1., paint samples 557 and 559).*** The 1797 plaster scratch coat on the east side was reworked with 1841 plaster on the face when the fireplace opening was reduced in size. A new length of baseboard was reproduced, and a "new" 1841 white marble mantelpiece added. Masonry changes to reduce the width of the fireplace opening and possibly the depth, together with the installation of the present four-piece, cast-iron fireback with an

*This horizontal nailer was probably used to secure the earlier and larger fireplace mantelpiece.

**This wallpaper has been assigned to the Van Buren ca. 1841 alterations because of its use in room 105, where Van Buren removed the chair rail, covered the new plaster infill with this paper, and installed a scenic wallpaper.

***Paint samples not included in this section are on file at the NAHPC.

elongated patera on each panel, may also be dated to Van Buren's ca. 1840 period of alterations.

Changes in the decorative wall finishes in room 104, beginning with the ca. 1840 Van Buren period, are supported by both physical and documentary evidence. In 1978, when a large pier mirror was removed from between the east wall windows of room 104, a large section of early wallpaper, extending from the baseboard to several inches above the window casing, was found. This wallpaper is composed of black star motifs on a gray ground (005). In areas where the chair rail was removed, it is lined with the green paper associated with Van Buren's work in room 105 and therefore has been dated to 1841. This black star wallpaper is described in the 1936 Weig report as an "original wallpaper [star design-green border]" (NPS, Weig 1936, 47). Two photographs dating to ca. 1930 (HP19 and HP34) confirm that the paper was still on the walls, with small portions missing on the chimney breast. The mirror, behind which the wallpaper was found, was probably installed during Van Buren's residency. It required removal of the 1797 baseboard and chair rail and chiseling of the floorboard to half its depth to receive it.

Removal of the 1797 chair rail was necessary for the Van Buren wallpaper installation. Horizontal plaster infill is visible throughout the room, together with ghosts from the green lining paper used in the chair rail area. Similar evidence may be found in rooms 105 and 106 to further document Van Buren's removal of chair rails.

The fireboard for this room has a scenic paper with a lion and tiger in a Rococo-style frame. The border is a gray leaf design on a green background. This border is assumed to be the same as that used on the walls and described in the 1936 Weig report as a "green border."

Remnants of a blue and pink floral paper were found above the Van Buren star pattern, between the windows in the east wall. The green paint on the plaster walls appears to post-date this blue floral paper, which is itself painted over in areas. Plaster repairs and removal of the cornice astragal molding in preparation for later wallpapering can be dated to the ca. 1960 Campbell period based upon the same occurrence and photographic documentation in room 106.

Other changes in room 104 include the ca. 1854 introduction of a hot-air register in the south end of the west wall (see IP026 and section IV.C.), radiators on the east and north walls, and varnishing of the wood floor ca. 1960.* Previous insect damage, from wood bores and silverfish, may be found on the floors and the east wallpaper.

Finish woodwork consists of the same detailing on door and window casings and baseboards as the front parlor on the south

*The floor varnishing has been attributed to Campbell in rooms 104, 106, 111, 119, 201, and 105.

side, room 106 (see section VI.B.). Comparative paint, molding, and hardware evidence is supportive of a 1797 date for nearly all architectural elements in both rooms. The exceptions to this are the chimney breast baseboard reproductions by Van Buren in room 104 and door 133 and its casing in room 106.

The two door architraves are surmounted by entablatures not appearing elsewhere in the house (see IP022). It is a vernacular interpretation of a Doric entablature, with two vertical projecting members resembling capitals of pilasters on either side of a plain frieze and a cornice including concave dentils. The cornice projects (in risseau) around these pilasters. Paint analysis confirms the date of the entablature to be the same 1797 date as the architrave, even though the entablature visually appears to be an afterthought.

The window and door casings consist of an ogee (cyma reversa) and bead, with an additional applied bead and cavetto. Baseboards are composed of an astragal molding and cavetto.

The doors in room 104 (D102 and 103) are hung with cast-iron butt hinges, the five-knuckle, ten-hole, 5" by 3" hinges dated to 1797. They have silver-plated mortise locks that date to before 1850. On the room 104 side of these doors is evidence of earlier rim locks, indicating that these locks do not date to 1797.

The plaster cornice is the same as other first-floor cornices (rooms 101 and 109), although not quite as decorative as the cornice design in rooms 105 and 106. Only the two front rooms, however, share the feature of a plain plaster wall frieze defined by an astragal (see section VI.B).

A mechanical bell system included a bell crank on the west side of the fireplace with a connection to room 005, the servants' dining room (see section IV.C.5).

Floorboards are of random widths laid in a north-south direction with a varnish finish.

The following preservation and restoration work is recommended for room 104:

Replace the plaster cornice astragal molding.

Remove the radiators.

Make miscellaneous plaster fills and repairs.

Remove the cast-iron backing and investigate the masonry condition.

Remove and conserve the remaining black star wallpaper (WP003) and reproduce the paper for all remaining walls; restore the fireboard scenic panel and rococo border.

Reconstruct the missing shutter leaf.

Replace the missing hardware: four shutter pulls, two butt hinges, and the shutter bar.

Restore the ceiling and cornice using calcimine paint.

Restore the woodwork to a cream color (Munsell 5Y 9/2, Benjamin Moore GB-60).

Remove the wood floor varnish.

e. Room 105 - Banquet Hall

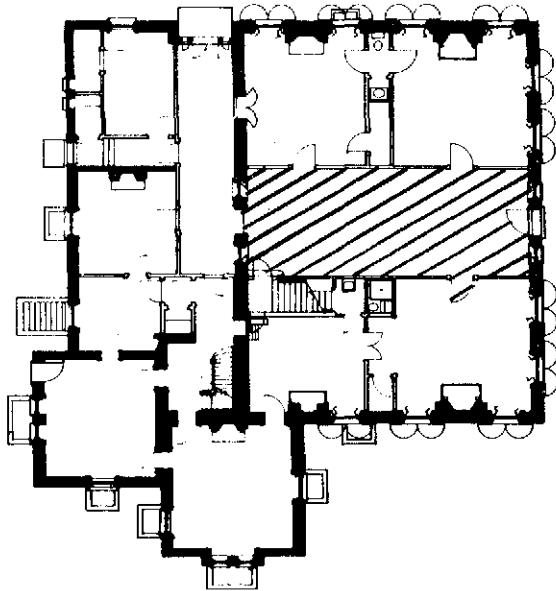

This room occupies the entire depth of the central portion of the first floor within the 1797 structure. Its original function was as an entrance hall both from the front (east-D101) and the back (west-D108) into rooms on the north and south and as a stair hall to the second floor.

The available documentation for the early 1840 period describes room 105 as a "Hall." There are two letters written by Angelica Singleton Van Buren; one on June 7, 1842, refers to "the Hall sofa" (letter to Mrs. Richard Singleton), and one on August 24, 1845, to the "Hall paper" (both letters in Angelica Singleton

Van Buren papers). The letter of May 15, 1841, from Martin Van Buren to Harriet Butler also refers to the "lower Hall" (Downs Collection). Although the 1938 DeProsse drawing and the 1970 Lindenwald Master Plan label this room as a "Banquet Hall," no period documentation has been found to support the use of such a name. The existence of a dining table capable of seating thirty guests does suggest a dining room function.* It would be most accurate, however, to use the documented terminology of "Hall."

The changes that transformed this room into a hall with dining capabilities were part of the most extensive changes initiated by Martin Van Buren in the early 1840s. The strongest evidence for attributing the removal of the staircase from this hall to Martin Van Buren is the installation of a scenic wallpaper (see HP16, HP17, and section VI.C.2. for wallpaper description). This paper could not have existed on all four walls in the presence of a stair.

An 1841 letter refers to the selection of wallpaper for room 105. Dating of the existing scenic wallpaper to 1831 and a lack of

*Park documentation should be referenced for the dining table provenance.

physical or documentary evidence suggesting work by the previous owner, Paulding, has resulted in a weak but plausible case for attributing the scenic wallpaper installation to Martin Van Buren.

The physical evidence for the original stairs consists of very subtle markings on the floorboards, plaster walls, and ceiling. A small Dutchman currently fills the mortise for the newel post tenon approximately 17' from the west wall and 4'6" from the south wall. A very slight change in floorboard color indicates the first riser location and a north-south crack in the plaster ceiling corresponds well with the required opening in the second floor framing system. It is assumed from this evidence that the 1797 stair was constructed along the south wall, ascended toward the west with a landing along the west or rear wall and a final run along the north wall, toward the east. The resulting U-shaped stair appears to have been stylistically typical for its period.

An infill of floorboards at the southwest corner suggests a fairly steep run of stairs from the first floor to the basement, descending toward the east (see IP027). This stair would have been under the main stair.

Additional markings on floorboards are 19'4" from the front (east) wall. The markings consist of faint scribe lines and a slight color change, and they identify the location of an earlier north-south partition. The fact that the scribe lines are on top of a finished floor surface indicates that this partition was probably not original. The wall thickness of 6-3/8", which includes a stud, plaster, and baseboard, extends from the north and south walls, 3' 9-1/4". The midsection markings are those of a threshold to the rear (west) side of the partition. Folding doors approximately 3'8" in width may have reasonably hung in this space, having adequate clearance of the stair newel post and enough space to remain in an opened position at the back (west) side of the partition wall. Other evidence indicating the location of this partition includes a crack in the plaster ceiling, a patched cornice, and a vertical break in the ca. 1797 painted plaster.

Relocation of the stair in the early 1840s required filling in the former stairwell opening. Because the existing ceiling has three circular medallions with a direct proportional relationship to the entire ceiling length, the medallions have been dated to the 1840s alterations. The plaster cornice, frieze, and torus molding are 1797 elements, with a few exceptions. The west wall and west end of the north and south walls required reproduction work in the area of the original stair. An astragal molding and the ceiling were also newly constructed in these areas and were altered to form a continuous line through the earlier partition. The ghost marks show cut corners where the earlier partition divided the hall space. With the removal of the scenic wallpaper for conservation treatment in January 1979, more extensive plaster changes were also found.

Plaster infill marks the location of what is assumed to be the 1797 chair rail. This evidence is found on the east (front) wall and the eastern ends of the north and south walls. The remaining north and south wall areas have a different plaster material entirely, with no

chair rail evidence. Surviving details of earlier decorative wall schemes also help to indicate the extent of plaster wall reconstruction: The east wall and the east ends of the north and south walls in the hall, with the chair rail area excepted, have free-hand painted decorative borders painted directly onto the plaster. The borders surround the doors, windows, baseboards, and former chair rail locations and serve as a frieze below the cornice. They consist of festoons of fruit and flowers. The free-hand wall coverings were painted over once with a blue paint before the scenic wallpaper was hung. The west ends of the north and south walls are later and are not decoratively painted. They have a plaster white coat with no paint. Split lath visible in room 108 suggests that the 1797 lath was reused and that early scratch and brown coats may still be extant.

On the south wall the decorative paintings cover an area of 50 square feet on the west side of the front parlor door; on the north side they cover approximately 35 square feet. The decorative paintings occupy the upper sections of wall area, with plaster repair below. The south wall bears an inscription in white, "FDPK," and one in black, "Perry Bradley," Both north and south walls of white-coated plaster have wavy lines of irregular finish marked by a light brown color. This may have been an area of overlap in two phases of plastering the wall. All areas of chair rail infill and plaster wall reconstruction received a green lining paper. Because this paper and its markings are associated with Martin Van Buren alterations, it serves as a dating indicator wherever it is found.

Other ca. 1840 Martin Van Buren work includes installation of the existing door in the west (rear) wall and casing of the two window openings in the west wall. It is not known whether windows existed in this wall prior to Van Buren's removal of the stair.

Richard Upjohn also designed alterations in this room within nine years of Martin Van Buren's changes. Paint and wallpaper evidence dates the present stair hall entrance (D130), related baseboards, and entire stair construction to Upjohn's work in 1849.

Subsequent intrusions include hot-air heating system registers ca. 1854, one midway in the north wall baseboard and one in the northwest corner of the floor. A later register (ca. 1840), 3'4" square, associated with a kerosene burner, was also installed in the northwest area of the floor. There is a hot-water radiator in the southeast corner. Recent plaster patching around the east entry door may relate to the ca. 1849 porch and its deterioration.

The woodwork in this room includes five doors, six door casings, four windows and window casings, and baseboards. The paint study and molding profiles show three periods of woodwork represented--1797, ca. 1840, and 1849.

The 1797 detailing includes the two interior door openings on the north wall and one on the south wall (D102, 107, and 136; see IP028). The doors are six-panel doors with recessed panels and integral molding at the outer edges of the panels and applied molding

forming a rectangular outline on each raised panel. The door casings consist of an architrave surrounding the opening, with base block, surmounted by an entablature with frieze and cornice. The composition of molded parts is a vernacular interpretation of classical details. Although the placement of the various parts does not attempt to adhere closely to classical principles, it is vaguely reminiscent of the Doric order. The groupings of reeding, fluting, and incised sunburst detail at the frieze are similar in their placement to metopes and triglyphs of the Doric order.* The upper baseboard of alternating groups of five flutes with flat areas (similar to the architrave detail) rests on a lower, plain baseboard, which makes a similar although vague suggestion of the Doric order rhythm. These doors are hung with cast-iron butt hinges--the five-knuckle, ten-hole, 5" by 3" type--dated to 1797. They have silver-plated mortise locks dating to ca. 1840, which appear to have replaced earlier rim locks (see section VI.D.). Paint samples taken from these doors contain a full sequence of layers, further confirming these 1797 dates (see section VI.C., paint samples 228, 229, 236, 237, 238).

The east wall entry door opening (D101) and windows share paint layering and portions of the same molded detailing as other 1797 elements (see section VI.C., paint samples 049-0 and 230). The casings are a simple composition of three parts, mitered at the corners, varying only in the width of the flat midsection of fascia. The door is a Dutch door hung with four HL hinges (see HP35). The interior panels are beaded and flush with the rails and stiles "bead and butt." Door 101 has a silver-plated mortise lock dating to ca. 1840 (see section VI.D.1.d). Markings on the door indicate that it had an earlier rim lock. The present lock is the same as the lock on door 108, which has been dated to the ca. 1840 Van Buren work on the basis of paint analysis. Window jambs are splayed to accommodate three-leaf shutters hinged at one side and between leaves with butt hinges. The panels are recessed, with integral moldings at the rail and stile edges and applied moldings outlining a rectangular portion. Wrought-iron bolts, at foot and head, secure the shutters in a closed position.

The second period of woodwork appears to date to the early 1840 alterations by Martin Van Buren. This work is found on the west wall, which has two windows and one door opening. Subtle variations in moldings and an absence of early paint layers on woodwork and plaster indicate a period of work later than 1797 (see section VI.B. for molding casing of door 108; and section VI.C.1., paint samples 241, 243, 244). The moldings are close reproductions of the east (entry) wall moldings as are plaster cornice moldings where the 1797 stair was located. The door molding used at the recessed panel edges is a Greek Revival profile appropriate for Martin Van Buren's period. Attributing all of this work to Martin Van Buren, ca. 1840, is supported by his installation of wallpaper, the removal of the stair, and his tendency to reproduce 1797 elements where possible. The four fixed sash (W103, 104, 128, 129) also appear to date from this period.

*The sunburst motif is also found in room 106 and on the exterior door entablature of the entry door 101.

Baseboard replacement sections are found on the north and south walls where the partition and stair were removed (see section VI.C.1., paint samples 054-056).

The third period of woodwork is that work designed by Richard Upjohn in 1849. Paint and stylistic evidence indicates that the present stair entry opening (see IP029), treads, risers, and related baseboards date to the 1849 period (see section VI.C.1., paint samples 226, 475, 476). Continuation of the Van Buren scenic wallpaper behind these elements confirms a reworking of the staircase soon after Martin Van Buren's ca. 1840 relocation work. The ca. 1840 stair may have been a steeper, straight run compared to Upjohn's addition of a landing two steps up from the hall floor. The Martin Van Buren plan may also have maintained through-access to room 109.

The 1797 floorboards are untreated, run in an east-west direction, and are of 3-3/4"-6" random widths. During Van Buren's residency, they were covered with a Brussels carpet.

Physical evidence located on the east wall of room 105 indicates that this room contained elements of the house's mechanical bell system. A hole in the casing of door 101 appears to be the location of a door pull. A rectangular box above door 101, containing a bell wire pivot, was also part of this system. Historic photograph 10 shows a bell hanger (without bell) over door 130. Scraping the face of this arched door casing uncovered the putty-filled hole where the bell hanger had been.

The preservation and restoration work recommended to restore room 105 includes the following:

Stabilize the plaster ceiling.

Repair the plaster cornice.

Consolidate and repair the plaster walls.

Conserve and rehang the scenic wallpaper.

Restore all woodwork to a cream color (Munsell 5Y 9/2, Benjamin Moore GB-60).

Restore the ceiling and cornice using calcimine paint.

Remove the radiators.

Install a bell pull and wire on the south side of door 101.

Restore the hot-air registers (ca. 1854) in the north wall baseboard and northwest corner of the floor.

f. Room 106 - Parlor

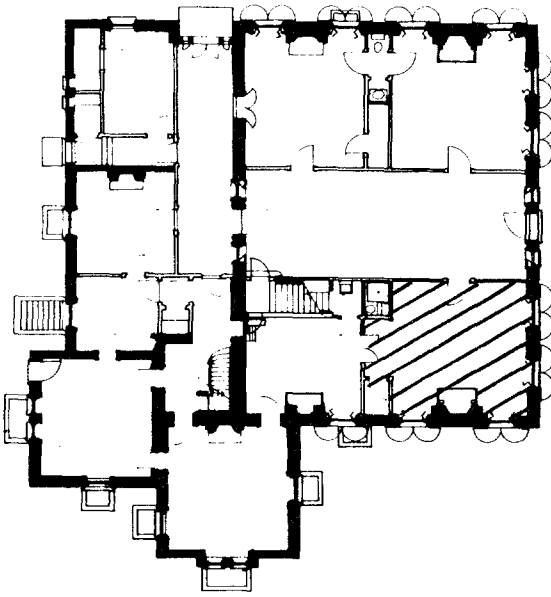

Room 106 occupies the southeast corner of the 1797 house. It is entered through a door opening in the north wall (136) from the central hall, room 105. Two window openings are in the east or front wall (101, 102), and a chimney breast flanked by two windows (126, 127) is in the south wall. An ogee arch in the west wall frames an alcove with double doors (133) leading into room 109 and includes side doors (135, 134) into two small closets, rooms 107 and 108, respectively.

Documentary evidence relating to the name and function of this room derives from 1841 correspondence between Martin

Van Buren and Harriet Butler. A careful analysis of the two documents has resulted in the conclusion that room 106 was called the drawing room. Out of the eight room names mentioned by Van Buren, the following were immediately eliminated as being inappropriate: "hall upstairs," "temporary Bed Room," "lower Hall," "best Bed Room," "Martin's Bed Room," and "Bed Room upstairs." The remaining two rooms were described by Van Buren in the letter of May 15, 1841, in the context of wallpaper selection:

No. 3. Let this be of the same kind with that which was sent for the dining Room, yellow with gold &cNo. 6. . . . Messrs. P. & F. will know (Downs Collection).

Harriet Butler references the wallpaper selections for each room using names for no. 3 and no. 6 instead of Van Buren's numbering system. A process of elimination leaves the "drawing room" and "dining room" as representing no. 3 and no. 6. Harriet Butler's letter to Van Buren of May 17, 1841, reads:

The borderings for the fireboards you will take like the borderings on the rooms for which they are intended. There was no pattern among them that would match very well with the drawing room paper . . . there was one gold one which I thought might answer for the dining room (Van Buren Papers, CCHS).

Physical evidence of wallpaper in situ and from fireboards in rooms 106 and 109 lends strong support for the drawing room/dining room functions. The east wall of room 106 has a gold-striped paper on a white ground (006), which could correspond to the "yellow with gold" paper suggested by Van Buren. This paper is between the two window openings, and until 1978 it was covered by a pier mirror. All other plaster walls were stripped of wallpaper during plaster repairs dating to 1958 from pencil markings on the walls, such as "HS Burrell, Valatie, 3/27/58."

Two layers of paper precede the gold-striped paper (004 and 005). Stylistically, they have been dated earlier than 1840. Of greater significance, however, for dating the gold-striped paper to the Van Buren period is the existence of the familiar green lining paper in the area of the chair rail infill and immediately under the gold-striped paper. It is also consistent with the correspondence cited above that the border for the drawing room fireboard does not match the border used on the walls.

An additional reference to a drawing room may be found in a narrative written by Martin Van Buren in his autobiography. He describes an early encounter at Lindenwald, when the house was inhabited by the Van Ness family: Van Ness "spoke to his father, (who passed into the drawing room without looking behind him)" (Fitzpatrick 1920, 17). In light of the foregoing evidence, it is possible that Van Buren, standing at the front door, which is hinged on the right (or north) side, could see Van Ness' father walk into room 106. The name "drawing room" may have been Van Buren's in origin.

The 1970 Lindenwald Master Plan includes a first-floor plan designating room 106 as the "red room." No documentation has yet been found to substantiate this claim, beyond the 1938 measured drawings by Victor A. DeProsse.

Alterations in this room have been limited to decorative wall finishes, the fireplace masonry and mantelpiece, and the west wall double doors. They will be discussed in that order.

The most recent wallpaper was removed by the park maintenance staff in 1978. Plaster repairs were exposed and dated to the 1958 markings by "HS Burrall." These repairs extended over the location of the cornice torus molding and frieze, except in the alcove area. Removal of the torus molding has, therefore, been given the 1958 date. A single "maroon" paint layer, now exposed on all walls, predates the 1958 plaster repairs. Photographs confirm that the torus molding was in place during the DeProsse residency (see HP13).

The most significant evidence for the evaluation of wall finish is between the east wall windows in the space where a pier mirror covered the wall before its removal in 1978 (see IP030). The uppermost wallpaper in the mirror space is a gold-striped paper on a white ground. It is lined in the chair rail area with the familiar green-patterned paper. The association with this paper, used only on the newly plastered chair rail infill as a lining paper, dates the gold-striped paper to Van Buren's time. Subsequent wallpapers shown in ca. 1930 and Campbell photographs were stripped before painting the walls (see HP39 and HP40). Installation of the mirror--probably during Van Buren's residency--required removal of the baseboard and a floorboard section, but it resulted in the preservation of the ca. 1841 wallpaper. The location of the earlier chair rail can be seen from the plaster infill on all walls. Its removal has been dated to Van Buren's work because of the lining paper association in room 105 and the north wall construction without a chair rail in room 109.

Fragments of two wallpapers, also found in the pier mirror location, do give ample suggestion of pre-Van Buren decorative schemes. The earliest wallpaper (004) has been stylistically dated to 1800 and may well be the original Van Ness paper. It is a handmade paper with a blue ground; onto this ground are painted clusters of red flowers with three blossoms, green leaves, and black veins. This paper has a border of pink swags on a blue ground that may correspond to the earliest paint color of pale green found on woodwork and on the plaster wall below the chair rail (see section VI.C.1., paint samples 247-54). The second pre-Van Buren wallpaper may date to William Van Ness' residency between 1815-20. This wallpaper has a large leaf pattern of white with light purple veins and dotted shading (005).

Alteration of the fireplace masonry represents a second area of change. The indications of change include a horizontal nailer set flush with the plaster 10" above the present mantelshelf, dark gray mortar at the fireback, an extended depth and width at the smoke shelf and flue, and traces of the Van Buren green lining paper below the nailing board. The masonry and nailboard suggest a wider, deeper, and higher fireplace opening. The lining paper provides an additional clue to changes in plaster, because it extends outside the usual chair rail area. It was assumed that baseboards on the front of the chimney breast would have been of shorter length given a wider opening, so they were studied carefully. Although paint layering was the same on the baseboard on the front and sides of the chimney breast, extraction of nails proved that later cut nails were used when compared with nails used elsewhere in the room. It was concluded that Van Buren probably reused baseboard sections from the front baseboards. The existing gray marble mantelpiece has been dated to the early 1840s work by Martin Van Buren on the basis of masonry and plaster wall changes and his use of later cut nails.

Installation of a system for introducing fresh, heated air was made possible by the reduction in the size of the fireplace openings. The relationship of this system to the masonry changes described above and the design similarity between ca. 1840 sash locks and the hinged covers at the air intake openings date this system to ca. 1840. A more detailed description may be found in section IV.C.2.

The third and last area of major change in room 106 took place at the west wall opening (D133) into room 109 (see IP031). The chromochronology for the door casing and doors does not match other elements in the room. Paint samples from these elements do not include the lower paint layers (see section VI.C.1., paint samples 245, 246, 251, 253). These missing paint layers suggest that Van Buren made these alterations ca. 1840. The plaster infill of chair rails on the room 109 side of the opening butts against the door architrave. Moldings appear to match door 136 (into room 105), although it has been established in several instances that Martin Van Buren reproduced existing molding styles. The hardware for door 133 consists of two-knuckle six-hole cast-iron butt hinges similar to those used by Upjohn in other areas, but they are attached with later machine-made screws that date to ca. 1830-40 and a silver-plated mortise lock dating to ca. 1840. There are no markings on these doors to indicate an earlier rim lock (see section VI.D.1.d.).

Other minor changes include plaster infill at the east wall cornice, installation of ca. 1840 sash and sash locks, infill floorboards at the pier mirror location (occasioned by insect damage), radiator additions, and piping holes in the ceiling, quarter-round molding on the east wall at the floor, and varnishing on the floor.

The existing woodwork in room 106 is the most decorative and formal of all woodwork remaining from the 1797 period of construction. With the exceptions noted above, all woodwork dates from 1797.* The earliest paint layer shared by all elements is a pale green. An ogee arch frames the west wall alcove and is supported by simple pilasters with tracery detail. The door casing (D136) on the north wall is unique in this house, excepting the similarities found on the duplicated parts of the west wall double-door casing. The architrave for this main access is flanked by pilasters and a full pedimented entablature. The dentil course is a vernacular design with vertical groups of three open circles between dentils.

The matching door casings for openings leading into the room 107 and 108 closets (D134, 135) are also of unique design. They are typical, however, for 1797 work because of the vernacular interpretation of classical principles. The architrave molding is the same design as that used for window casings and for the ogee arch. The frieze includes incised sunbursts (similar to those found in room 105) alternating with units of reeding flutes. The cornice includes a convex dentil course and a series of five flutes divided by incised circles in the corona location.

The hinges used to hang doors 134, 135, and 136 have been dated to ca. 1797. Their locks are silver-plated mortise locks dated as pre-1850. Markings on the doors, however, indicate they replaced earlier rim locks. The difference in hardware between doors 134, 135, 136, and 133 further supports the contention that door 133 was altered ca. 1840.

The window casings have splayed reveals to receive folding shutters. The moldings are mitered at the corners and match the two other primary spaces, room 104 and 105. The recessed, paneled wainscoting at each window also matches room 104. With sash lock evidence and muntin profiles, the six-over-six window sash has been dated to the early 1840s.

Baseboards are the same design as those used in rooms 104 and 105. Except for one early paint layer variation, the baseboard paint finish was found to concur with other woodwork (see section VI.C.1., paint samples 250, 251, 253).

It is significant to note that all eight drapery hooks are in place, two over each of the four windows. This handwrought iron hardware is secured directly through the plaster and into the masonry

*See section VI.A. X-ray investigation showed similar nails from the 1797 period of construction in both D136 and in the ogee arch pilaster.

wall. They are approximately 5" in length with a short upward bend, are 3-7/8" above the window casing, and are the only such examples in the house. There is no evidence in the surrounding plaster to indicate a date other than the initial construction date of 1797. Other hardware includes four picture-hanging buttons.

A mechanical bell system included a bell crank on the west side of the fireplace with a connection to room 005, the servants' dining room. The physical evidence and functioning of this system are described in section IV.C.5.

Floors are of 1-3/8"-thick, tongue-and-groove boards, varying from 4" to 6" in width and running in a north-south direction. Tack marks indicate 3' widths of grass matting. A sample of this matting found under the pier mirror indicates that this floor covering dates to ca. 1840.

Restoration of room 106 to a drawing room of the Van Buren period will include the following work:

Conserve the early wallpaper on the east wall, if possible in situ.

Reproduce the gold-striped wallpaper (006) and its border.

Conserve the fireboard scenic wallpaper and border.

Remove the plaster fill along the upper portion of the east wall cornice.

Repair the plaster, including patching holes and creating a smooth surface over the chimney breast stovepipe openings.

Reconstruct the cornice torus molding.

Rebuild the rear wall masonry of the fireplace to duplicate other similar Van Buren work, possibly to be found in room 104, and remove the later hearth and mitered wood surround.

Replace one shutter pull.

Remove the radiators.

Restore all woodwork to a cream color (Munsell 5Y 9/2, Benjamin Moore GB-60).

Restore the plaster ceiling and cornice using a calcimine finish.

Strip the varnish from the wood floor.

Install a bell system wire and reproduction crank on the west side of the chimney breast.

Restore the fresh-air intake system, including removal of the duct fill and installation of reproduction parts (horizontal duct, metal plate, two interior and one exterior covers).

Reproduce the missing knobs for door 134.

g. Room 107 - Storage

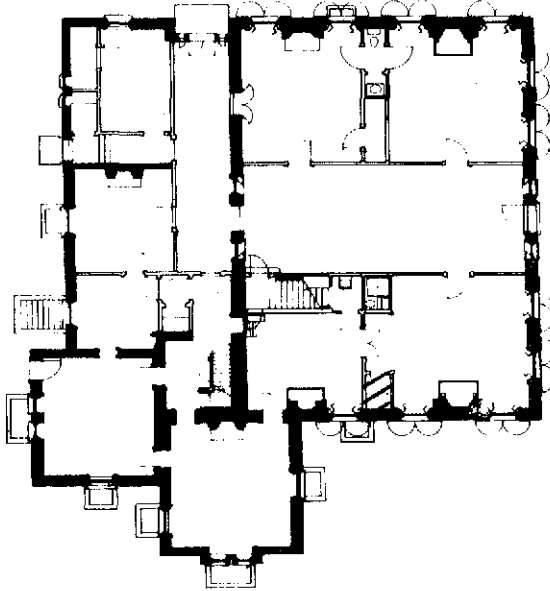

Room 107 is a small closet on the south side of the 1797 house between rooms 106 and 109. This closet is entered through a door opening (135) in the north wall from an alcove in room 106, the drawing room. Rooms 107 and 108 maintain a symmetrical relationship with rooms 102 and 103 on the north side of the central hall, room 105. The treatment of the four closets is different, however.

Changes in room 107 include a reworking of shelves and holes in wood and plaster to accommodate heat and water supply pipes. All remaining fabric in this closet is from the 1797 period of construction.

The shelf system consists of hand-planed vertical boards of 17-1/2" to 18" width against the extreme south ends of the east and west plaster walls. A top shelf rests on the tops of these vertical boards. Three additional shelves are rabbeted into one another and rest upon the north door casing to form a continuous four-sided shelf at this height. The lower four shelves are supported by molded ledgers nailed into the vertical boards.

Other woodwork includes the door casing (matching its room 106 architrave) and the baseboard. The plain baseboard is a typical closet baseboard for the 1797 period.

The plaster walls have a white-coated finish and are painted a blue gray above the top shelf and white below the top shelf.

The ends of the horizontal board construction supporting the ogee and are visible at the upper north end of the east wall.

Restoration recommendations for this closet include the following items of work:

Patch all holes.

Duplicate one shelf ledge and three shelves.

Whitewash the plaster walls above the top shelf.

Restore all woodwork to a cream color (Munsell 5Y 9/2, Benjamin Moore GB-60).

h. Room 108 - Closet/Stair/Bath

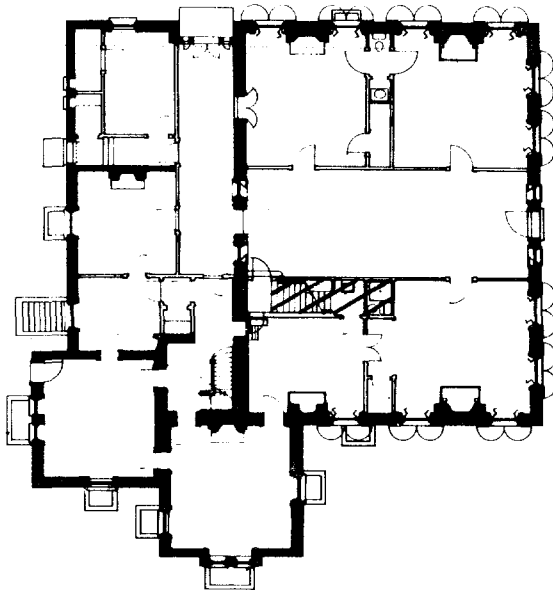

Room 108 is a small closet between rooms 106 and 109 on the north. There are three door openings into this closet, including a door from the room 106 alcove (D134), a door from room 109 (D132), and a door on the west wall into a stair hall leading to the basement room 005 (D131).

The major change in this closet appears to have occurred when the central hall stair was relocated by Martin Van Buren in the early 1840s. The physical evidence suggests that the stair access into the basement was relocated to maintain the parallel relationship between both sets of stairs.

Evidence along the north wall of this closet, continuing along the same wall in the lower stair, makes it clear that the west wall of this closet was moved farther east to make room for the "new" stair. Plaster infill marks the original partition location. On the west side of this infill the plaster walls have the same decorative painting as the walls in room 109. Evidence of the earlier chair rail is also present on the west side of the infill. On the east side of the infill no decorative paint or chair rail evidence is present. A red and blue paint identifies the location of shelving that runs across room 108. A change in slope of the plaster ceiling also marks the location of this change. The existing ca. 1840 partition has sawn lath, whereas the 1797 walls have split lath. There is a 1/4" difference in baseboard heights between the west and 1797 walls. The original west wall appears, therefore, to have been 2' 0" farther to the west and without a door.

The second and most extensive change occurred with the installation of a sink, toilet, and shower stall. The oral history of the DeProsse family indicates the introduction of toilets by ca. 1920. Any changes in the system and addition of the shelves probably date to the Campbell residency. Holes were made in the wood floor for water supply and drainage. A large area of the plaster and lath was removed from the east wall to accommodate the shower, and an area of the north wall plaster was cut out for insertion of a medicine cabinet. Tile was glued onto the north and west walls.

Room 108 contains both ca. 1797 and ca. 1840 woodwork. The ca. 1797 woodwork includes the south wall door casings and doors (which match the primary room side) and most of the plain baseboards. The ca. 1840 woodwork includes the flat casing with bead for the west wall door and baseboards on the west and southwest walls.

The hardware of the doors in room 108 varies considerably. Door 131 is hung with three-knuckle six-hole cast-iron butt hinges, ca. 1840; door 132 is hung with five-knuckle six-hole cast-iron butt hinges, ca. 1840; and door 134 is hung with a cast-iron HL hinge, ca. 1797. Doors 132 and 134 have silver-plated mortise locks dating to ca. 1840; door 131 has a carpenter-type lock marked "J. Walker V.R. [Victoria Regina]" dating to after 1836 (see section VI.D.1.). This hardware suggests that doors 131 and 132 date from the ca. 1840 moving of the stairs by Van Buren.

Original plaster exists on all walls except the west. Plaster, ca. 1840, includes the west wall and angled ceiling and upper wall areas that correspond to the rise of the stair. It is possible that ceiling plaster was also redone during Upjohn's alterations of the main stair.

The plaster walls have a white cool finish. Originally they were painted to a height of approximately 7'. On the north wall this paint outlines shelving that stood along the full length of this wall. The shelving also extended 1'7" into the present stair area of room 005. The shelves were arranged at varying heights. Measuring up from the floor the first shelf was at 1'4-1/4"; the second at 2'; the third at 3'7"; the fourth at 4'8"; and the top shelf was at 5' 9-1/2".

The lower portion of the walls was painted red, the upper portion was painted blue. At about 7' a band of wave-pattern stenciled decoration occurred on all four walls of the room.

A fragment of wallpaper found above door 131 in this room suggests that it may have been wallpapered during Van Buren's residency. This wallpaper matches the wallpaper hung in Room 106. Evidence in room 109 suggests that this paper may have hung in that room as well.

Floorboards run in a north-south direction through to rooms 106 and 109. There are no markings that suggest alteration beyond those described above.

The preservation and restoration work recommended for room 108 includes the following items:

- Remove all plumbing fixtures and related piping.
- Remove the electric wiring and lighting fixtures.
- Remove the tile glue.
- Infill the plaster on the north and east walls.
- Replace and repair the baseboards.
- Patch the floor and remove the paint.

Restore the woodwork to a cream color (Munsell 5Y 9/2, Benjamin Moore GB-60).

Reproduce the gold-striped wallpaper (006) and its border.

i. Room 109 - Library/Den

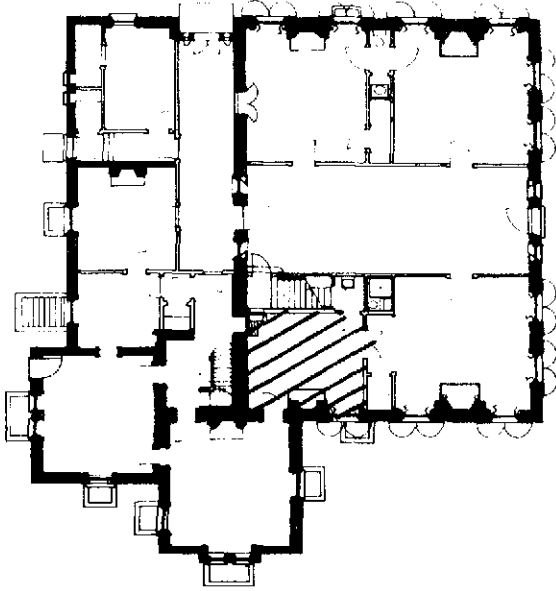

Room 109 is in the southwest corner of the 1797 house. In plan it is symmetrically opposite to room 101, a Van Buren bedroom. Although their functions appear to have differed, the decorative treatments for rooms 101 and 109 were similar. These rooms were secondary to the more formal front rooms (104 and 106) and central hall (105).

Five door openings lead into room 109. Primary access is through the east wall double doors from room 106 (D133), the drawing room. Circulation also exists into the 1849 addition, through the south and west door openings (D120 and 122). There are two

north wall openings--one leading into a closet, room 108 (D132), and one into the main stair hall (D129). There is one window (W125) and a central chimney breast on the south wall.

Documentary evidence for the function of room 109 is most convincing in 1849 correspondence. One letter from T.B. Van Slycke to Upjohn on October 23, 1849, refers to a "breakfast room door," while describing difficulties encountered in building the tower stairs (Upjohn Papers). The relationship between the final run of the stairs and the west wall door opening in room 109 is apparent. A second letter, from Smith Thompson Van Buren to Upjohn and dated December 3, 1849, confirmed this room's function in describing the flue problems. This letter states that "for the accommodation of the glazier a fire was started in the room in the old house under the breakfast room" (Upjohn Papers). Room 005, under room 109, is the only basement room in the 1797 house with physical evidence suggesting a fireplace. However, removal of some bricks from the opening revealed the fact that the brick back of the would-be fireplace had no accumulation of soot. There is also a stovepipe opening in this chimney foundation. The stove it served may have been the location of the glazier's fire.

Earlier 1841 correspondence between Martin Van Buren and Harriet Butler, although not as conclusive, does support a dining room function. Analysis of the two letters is as follows:

Van Buren refers to a "dining room" that has not been located elsewhere in the 1797 house through physical or documentary evidence (letter of May 15, 1841, Downs Collection).

Van Buren implies a relationship in wallpaper selection between his room "No. 3" and "No. 6" when he requests that the drawing room (no. 3) be similar to the dining room (no. 6), which had apparently already been "sent for" and hence Van Buren's remark that the firm "will know."

The names for Van Buren's rooms "No. 3" and "No. 6" may be derived from Harriet Butler's reply letter of May 17, 1841 (Van Buren Papers, CCHS). Her letter uses names without the numbers. By eliminating the four names and numbers that correspond between the two letters, one is left with the "drawing room" as "No. 3" and the "dining room" as "No. 6."

The "drawing room" has been established as room 106, which leaves room 109 as the "dining room."

In addition to the documentary evidence, there is also a necessary circulation that exists for the use of room 109 as a dining room. Service from the basement food preparation area is from two stairways: the tower stair with access through a west door and a more direct stair from room 005, the servants' dining room, through a north wall door. The change in room names from the 1841 "dining room" to the 1849 "breakfast room" may have resulted from a decrease in the use of the room for formal dining. Furnishings for the central hall, room 105, clearly indicate a formal dining arrangement for seating a large number of guests. Room 109, though called a "breakfast" room may have been used for all meals involving a small number of people.

The designation of "Den," which appears on the 1938 measured drawings by Victor A. DeProse has not been substantiated. Based upon the foregoing evidence, room 109 will be considered in its Van Buren-Upjohn context, as a breakfast room.

There are four periods of construction represented in this room. Except for the central hall, room 105, this southwest corner received the most extensive alterations of all first-floor 1797 spaces.

The first change, supported by physical evidence only, has been attributed to Martin Van Buren during the early 1840s. Many of the indicators of change are derived from the central hall, room 105, room 110, and the stair area of room 005. Relocation of the main stair is physically documented and described under those room headings. The space used for the "new" stair location was taken from the north area of room 109. Free-hand decorative wall paintings on the north side of the stairs that match the free-hand paintings on the other walls of room 109 clearly identify this alteration.

The original shape of room 109 included a small closet at the northeast corner. This L-shaped room made it unlike all other first-floor rectangular rooms of the 1797 house. The west wall of the closet, room 108, was moved to its present location (to the east) when the main stair and the stair to the basement were located in this area. Physical evidence in room 108 and particularly along the north and west walls supports the pre-Van Buren closet location. Additional evidence exists on the north wall of room 109. Although the north wall cornice

matches other walls, the absence of paint layering (paint samples 043, 044) and the vertical crack at the east side of the north wall (the original corner of room 108, closet) confirm its being a duplication. The north wall, in addition to having fewer paint layers (048), does not have plaster infill in the chair rail area. Dating the stair relocation to Martin Van Buren firmly dates the north wall fabric to the 1840 period also (see discussion of room 105 above). The absence of a chair rail on this wall further supports Van Buren as the author of the removal of all chair rails.*

The Van Buren arrangement of 1840 may have included access from the northwest corner through the stair hall and into the central hall, room 105. The earlier opening, also in this corner at the west wall, was either an exterior door or provided access to an attached space.

An additional change attributed to the ca. 1840 work by Martin Van Buren is found in the fireplace opening and firebox masonry. The visible evidence does not include the typical plaster, baseboard, or mantel piece changes found in rooms 104 and 106. Instead, the combination of painted plaster infill within the 1797 flat stone surround, straight-sided jambs (as compared to 1797 splayed jambs) with a deep inner hearth, and the same system for introducing fresh, heated air found in room 106 suggest that the original 1797 configuration has been altered. Similar masonry alterations in rooms 101, 104, and 106, and the introduction of the fresh-air intake system, are attributed to ca. 1840 work. It is possible that the details of these changes differ from those found elsewhere, partly because the width of the chimney breast in room 109 is the smallest of all first-floor 1797 chimney breasts.

The second major alteration occurred eight years after Van Buren's work, with the additions designed by Upjohn. A south wall window opening was reduced in width and height to accommodate a door opening into the library, room 111. Vertical marks at the plaster infill, the ca. 1797 painted border around the former window casing, and the molding used for the door casing are visible indicators of this change. A similar reduction occurred at the west wall door opening (120). In this instance, a larger door opening with a segmental arch in the brick wall was decreased in size to accommodate a smaller door opening.

The last change appears to have been made by the DeProse family during the 1940s when the house was in use as a nursing home. The ca. 1849 west wall opening (120) was relocated to the west end of the north wall. The earlier opening was closed off on the room 109 side only, and several steps were added to complete access from the first-floor landing of the main stair into room 109. This door casing and the infill at its original location were removed by the park maintenance staff in 1978.

The woodwork surviving from the 1797 period includes the window casing, the door casing into the room 108 closet, baseboards,

*The presence of a green lining paper on areas of chair rail plaster infill is the usual Van Buren connection deriving from room 105 evidence.

and the mantelpiece. Moldings used for the window and door casings match those found on other 1797 first-floor windows, although the composition may not always be the same. Baseboards are plain, with an ovolo molding at the upper edge. This treatment is typical for 1797 secondary spaces. The wood mantelpiece shares many features with five other mantelpieces surviving in the 1797 house. A molded architrave, mitered at the corners, is surmounted by a plain frieze that curves upward and inward to meet a simple entablature with dentil course.

No woodwork has been dated conclusively to ca. 1840 Van Buren work. The north wall baseboard which might otherwise have been ca. 1840 appears to have been reused. Door 133 on the east wall probably dates to ca. 1840. It is a double door hung on two-knuckle six-hole cast-iron butt hinges that are similar to hinges used in ca. 1850 work, but these are attached with later machine-made screws that date ca. 1830-1840. It has a silver-plated mortise lock and knobs that are marked "Hicks Manufg. Co. Patent." This patent was registered in 1840. The paint on this door includes a first finish layer of cream paint that does not occur on door 128. The door casing consists of a double architrave molding, similar to ca. 1797 profiles in composition, but different in overall size and with a shallower ogee profile. The wall surface around this casing was not painted with the border pattern that surrounds the ca. 1797 openings. The ca. 1840 chair rail patch butts directly against the casing.

Upjohn woodwork is represented by the west and south doors and their casings (120, 128). The west wall door and casing are black walnut and appear to have had clear finishes. This door is mentioned in 1849 correspondence as the "breakfast room door" (see section VI.C.1., paint samples 275, 276), and it may be the "black walnut door" (see section VI.C.1., paint samples 165, 266). The casing used for door 128 into the library, room 111, is an attempt to harmonize with existing moldings. Although its larger scale and actual profile differ, the composition of the parts is very close. This door is also of a unique design. Unlike the other doors installed by Upjohn, this door has a glass upper half with semicircular wood arch detail. Paint samples confirm that this is a ca. 1849 door.

Evidence on the plaster walls includes both ca. 1797 and ca. 1840 fabric, as described above. The 1797 plaster walls are not white-coated. In the areas above the chair rail, the brown coat of plaster was decoratively painted. This decorative pattern consists of two designs--large curvilinear stems and leaves cover the body of the wall and small borders in a similar motif surround the cornice, doors, windows, chair rail, and baseboards. The decorations were painted freehand. The colors used for the decorative paintings are black, white, and vermillion. The same decorative paint scheme is found on the north walls of rooms 108 and 110.

Floors are of random-width boards laid in a north-south direction. Remnants, of a ca. 1845 DeProse gray paint found under a west wall Campbell bookcase and the door 129 steps date the existing sanded and varnished finish to Campbell work. Tack marks suggesting grass matting are visible.

No wallpaper samples have been found in this room. Evidence found on the plaster walls, however, strongly suggests that the same wallpaper that hung on the walls in room 106 (WP006) also hung in room 109. This evidence consists of a pattern in the paint layers, revealed by light sanding, that matches the embossing pattern of wallpaper 006. The use of the same border on the fireboard in room 109 as on the fireboard and at the cornice in room 106 further supports the contention. This evidence suggests that rather than trying to find compatible wallpapers for the drawing room and dining room, Van Buren chose the same one.

No evidence of the mechanical bell system has been found in this room.

Recommended work to restore room 109 to a breakfast room/dining room of the 1841-49 period includes the following:

Stabilize the plaster ceiling along the west wall as well as the west wall itself; reconstruct the cornice.

Reconstruct the west end of the north wall.

Secure the walnut door casing and door (on site) in its west wall location.

Repair the window shutter: replace lock and pull parts, refasten the shutter leaf, and remove the later strap hinge lock.

Secure the baseboards, particularly along the west wall.

Restore the fresh-air intake system, including removal of duct fill and installation of reproduction parts (horizontal duct, metal plate, two interior covers).

Restore all woodwork, including the mantelpiece, to a cream color (Munsell 5Y 9/2, Benjamin Moore GB-60).

Restore the ceiling with a coat of whitewash.

Reproduce the gold-striped wallpaper (006) and its border; restore the fireboard and reproduce the scenic panel.

j. Room 110 - Stair

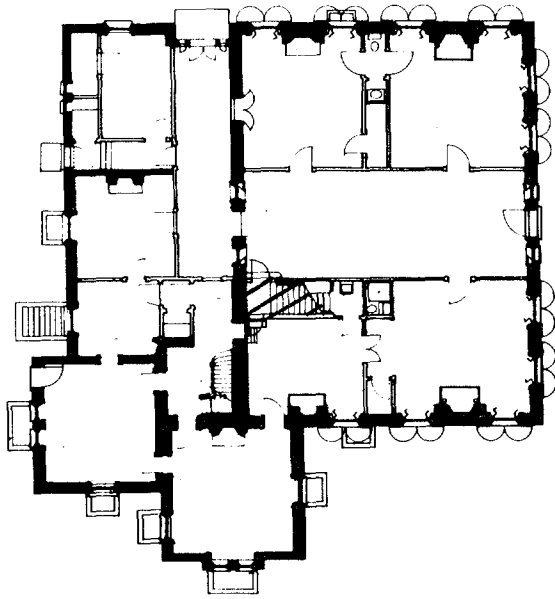

Room 110 is the number that has been assigned to the stairs that run from room 105 up to room 206. These stairs are located between rooms 105 and 109 in an area that was originally part of room 109. The north wall of the stairs is the 1797 north wall of room 109. Access on the first floor is from rooms 105 and 109; on the second floor it is only from room 206.

The stairs were first built in this location in 1840, when the staircase was removed from room 105. (See discussion of room 105 for the dating of this alteration.) In 1849 Upjohn rebuilt these

stairs. The existing stair treads and risers, handrail, and turned balusters date from this rebuilding.

Physical evidence for the 1840 stairs is scant, but some information about their layout has been gleaned from paint, wallpaper, and structural analysis. The stairs originally appear to have terminated at the level of the floors in rooms 105 and 109, in a passage between these rooms. Evidence for this location is a section of the balustrade wallpaper underneath the present stair baseboard on the west wall of room 105 and continuous floorboards between rooms 105 and 109. This location and layout of the stairs would have meant that the stairs had a steeper pitch than the existing stairs.

Access to the 1840 stairs from room 105 appears to have been through a door that originally connected rooms 105 and 109. Evidence for this door is a patch, in the shape and at the height of room 105 door entablatures in the west wall of room 105 (see IP024). This door was located under the original U-shaped stairs in room 105, suggesting that these stairs were not enclosed across the west wall.

The double studs in the wall between rooms 109 and 110 suggest that the 1840 stairs may have been wider than the existing stairs. Analysis of the plaster and nails from this wall confirms the presence of both ca. 1840 and ca. 1850 work.

The Upjohn stairs are 4' 5" wide and consist of 7-1/2"-high risers and 11-1/4" wide treads. They terminate in a raised landing, two steps high. From the landing, two steps descend into room 105.

The raised landing for the stairs required that the opening leading to the stairs from room 105 be enlarged. The opening was made approximately 18" higher and is arched. A decorative bracket was placed on the right side of the arched opening.

Two alterations to the stairs appear to have been made in the 1940s by the DeProse family. They built an opening from the top of the stair landing into room 109. Door 120, from the west wall of room 109, was used for this opening. Two steps connected this opening with room 109. This door and casing have been removed by the park maintenance staff. The DeProse family also installed a door in the opening to the stairs in room 105. This door has also been removed.

The preservation and restoration work recommended for room 110 includes the following items:

Reconstruct the stud and plaster wall in the door 129 opening.

Restore all woodwork, including the stairs and risers, to a cream color (Munsell 5Y 8/2, Benjamin Moore GB-59).

Restore wall surfaces with a reproduction wallpaper (WP015).

Restore the ceiling to a finish plaster white coat.

k. Room 111 - Library

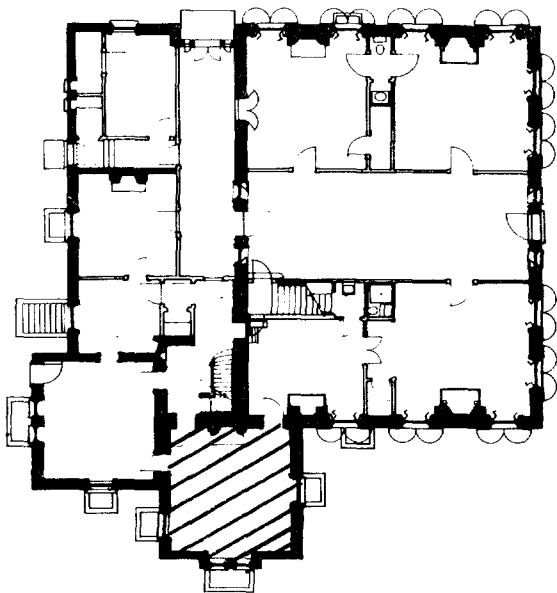

As part of the 1849 additions designed by Upjohn, this room is assumed to have been the library. The plan records of Upjohn's office include details for the bay window of the library (Upjohn Planbook), and room 111 is the only first-floor room with a bay window. This room adjoins the south side of the 1797 house so that access is not only from room 113 (D126), the tower stair hall, and the bedroom, but also from room 109 (D128), the breakfast room.

The Upjohn planbook provides the strongest documentation that has yet been found for the use of room 111 as a library. A May 30,

1849, entry in the planbook lists among other drawings sent to Smith Thompson Van Buren "Bay window in Library" and "Single windows of Library." Room 111 is the only room with both a bay window and two single windows. Faint, horizontal markings on the east, south, and west plaster walls suggest large furniture of approximately 9' in height, such as bookcases. Evidence on the walls is not pronounced, apparently because no furniture was attached directly to the walls. The projection of a typical Upjohn baseboard, designed for this room as a primary space, (similar to the hall, room 119) prevents attaching or closely positioning furniture against the wall unless the base of the furniture is coped to fit the baseboard.

The exposed plaster wall finish consists of residue from an original paint layer of brown. Removal of the casing of door 127 during January 1980 investigations provided evidence for this original painted surface. It is significant that the surface paint is limited to the area exposed only behind the north jamb and a portion of the north end of the lintel. The sharp delineation of a vertical paint line upward from the lintel to connect with a horizontal wall mark strongly suggests a bookcase outline. Such a bookcase on the west wall would have taken the area from the window on the south to this termination on the north, allowing adequate space for operation of the north wall door. Similar markings suggest bookcases in the southwest and southeast corners and a 3'-wide section north of the east window (W124).

Beyond the mention of Upjohn's plans for a library, there is ample correspondence confirming that bookcases with doors (probably using wire mesh) were completed by August 22, 1850, the date of a letter from Thomas C. Moore, who installed wire mesh, to Richard M. Upjohn (Upjohn Papers). The cabinetmaker was a man named Hollenbeck (Smith Thompson Van Buren to Richard M. Upjohn, June 28, 1850, Upjohn Papers).

If a decision is made to refurnish the library, there are several Upjohn designs in the collection of Avery Library at Columbia University that could be used as models. Two that seem appropriate are the "Bookcase for Mrs. Packer's Library/June 12th 1853" (IP032) and the "Design for Bookcase/for/ Mr. C. H. Russell/. . . October 21, 1853" (IP033).

An early change to this room occurred with the insertion of door 127 on the west wall connecting to room 112. This change required removing or relocating the bookcase that had occupied the location formerly, abandoning a small closet that had served room 112, demolishing a brick wall, laying new flooring, and installing jamb paneling and door casing. The physical evidence from these features is insufficient for the confident assignment of a construction date for this change. The evidence of a bookcase in this location means that the door was installed after August 1850. The paint layering on the door casing and jamb panels (samples P756 and P757) is so similar to other woodwork in room 111 that no distinction can be made. The cut nails used in the woodwork could have been made any time between ca. 1840 and ca. 1895. The fact that the new flooring in the doorway differs from the flooring used in the known ca. 1850 work suggests that the change was not made as an afterthought in the course of the ongoing project but was probably undertaken separately and later. Beyond the physical evidence, one must also consider functional evidence, i.e., what was the purpose of the change and is it consistent with other physical and documentary evidence? The intended functions of rooms 111 and 112 (as discussed elsewhere) were a library for Martin Van Buren and a bedroom for Smith Thompson Van Buren respectively. As long as the rooms served those functions, the need for more direct passage than already existed through room 113 is not apparent. When one considers the conversion of room 112 to a kitchen (ca. 1890), the need for direct passage to room 111 is readily justified by positing a dining room use of room 111. This is speculation, of course, and a determination of the date of this change must await the evaluation of other physical evidence by the North Atlantic Historic

Preservation Center. The results of those studies will be incorporated in their completion report for this project.

The second area of change is the replacement of double-arched windows in the south bay with a fixed sash of twenty-four lights ca. 1960 by Campbell (IP034). The elements not still intact include the center mullion and sill members. An interior photograph dated to the 1930s shows this bay window in its original form (MAVA F.6(b)/L1-L10).

The room is nearly 17' square, has two windows (121, 124), a double-arched bay window (122-123), three door openings (126, 127, 128), and a chimney breast on the wall adjoining the tower masonry. All woodwork is typical Upjohn--plain and large in contour. Single window units include sliding shutters of twelve panels and segmental-arched outer casings and upper sash. The bay window shutters are hinged, two-leaf shutters with separate upper and lower units. Wainscoting below the windows and recessed panels on the shutters and the jambs for door 128 (into room 109) are all detailed with the typical Upjohn molding.

All the doors in this room are hung with cast-iron butt hinges dated to ca. 1849. Doors 127 and 128 have silver-plated sheet-iron or steel mortise locks, ca. pre-1850, probably reused. Door 126 has an electroplated cast-iron mortise lock, ca. 1850 (see section VI.D.1.e.).

Walls are white-coated plaster with a layer of brown paint exposed following 1979 wallpaper removal. The upper portion of the east wall is marked: "Papered by Wilfred Sharpe, Valatie, N.Y., May 1921." There is also a very faint difference in the darkness of the brown paint at 9' high. This is most noticeable on the south side of the east wall and probably relates to bookcases.

The chimney breast has chamfered corners with lamb's tongue and a yellow marble mantelpiece. The opening is circular, with a keystone, chamfered and incised corners with lamb's tongue, and recessed areas of carved leaves and painted coats-of-arms. Black stone frames the semicircular opening and splayed jambs, and it covers the hearth. The fireplace back is brick. The width and height are 2'6" and the depth is 1'1". A filled-in stovepipe hole is at a central location, and other areas have plaster patches.

The wood flooring surrounding the outer hearth has an irregular pattern but cannot be proven to be a later change. The remaining floorboards run in a north-south direction, have a varnish finish, probably dating to the Campbell residency, and board widths are 3" to 4". A 1' by 1'4" area was cut and subsequently filled in at the northwest corner of the room. A larger area of 3'2" by 6'1" of similar infill exists at the northeast corner leading into room 109. Both areas are nailed with wire nails.

No evidence of the mechanical bell system has been found in this room.

A patched area of the plaster ceiling along the west wall fell during roof repairs of 1978. The 1" thickness of plaster and the sawn lath in this area is exposed.

Recommended restoration of this room will include the following items of work:

Reconstruct all details relating to the bay window.

Repair the plaster ceiling and further investigate to check the stability of the remaining ceiling.

Caulk around the outer edges of door and window casings.

Remove the stovepipe thimble, and patch to achieve a more even appearance.

Relocate door 128 from room 109 into the Dutchman-marked location of room 111 of the same opening.

Restore all painted wood finishes to a tan color (Munsell 10YR 8/2, Benjamin Moore CB-46).

Restore all plaster wall surfaces with a brown paint (Munsell 10YR 6/4, Benjamin Moore CB-9).

I. Room 112 - Bedroom

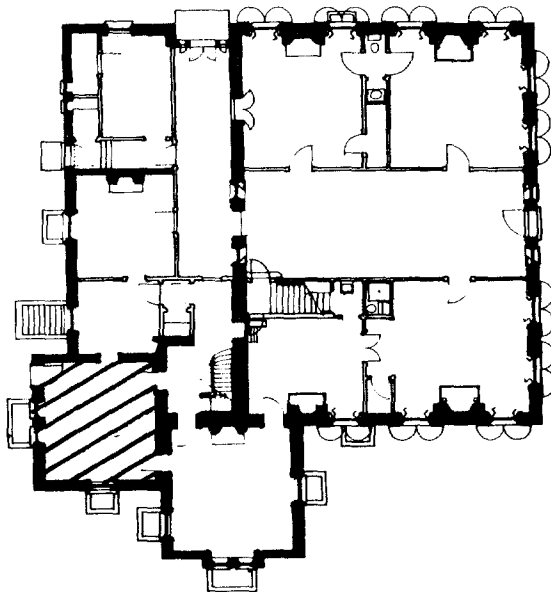

This room projects farther west than the other portions of the one-story 1849 addition. It is under its own batten-seam terneplate gable roof immediately to the west of the tower. The room may be entered from the tower stair hall, room 113 (D125); the library, room 111 (D127); the bathroom, room 114 (D122); and from an exterior door in the west wall (D124). There is one window in the south wall, a double-arched window in the west wall, and a fireplace in the east wall.

The records of Upjohn plans refer to details for a bedroom double window and a cornice for a bedroom. There is no other room that meets both criteria. A letter of October 4, 1849, from Barney McGuire to Richard M. Upjohn confirms the bedroom designation: "The Bedroom fire place has no projection. The opening of the fire place is 2'-5-3/4" (Upjohn Papers). Although this room probably functioned as a bedroom for Smith Thompson Van Buren, its later uses have varied considerably. In fact, no other space designed by Upjohn experienced to as much fabric alteration and deterioration as this room.

One of the earliest changes occurred at the south end of the east wall. The visible indicators of change included a reveal molding of later profile and a closet area plastered and later closed off by a stud wall. Room 111 casing and the jamb panels were removed by the park staff during January 1980 investigations to reveal a plastered closet 11" deep, 6' 4-1/4" long, entered from room 112. The door location is nearly equidistant from the ends of the closet.

Changing this closet into a passageway required cutting a brick wall opening, laying new flooring, and installing jamb paneling and a door casing. The woodwork was installed with cut nails, and the casing for room 111 matches the other Upjohn casings. (See room 111 description for discussion of this change.)

One of the most significant changes in relation to function is the addition of an exterior door opening in the west wall north of the double window. Paint layers on the door indicate that it was reused, probably from door 118 (PO97). The lack of a properly cut and framed opening in the exterior brick masonry, the interruption of the wall pocket for the sliding window shutter clearly indicate that it was a late alteration. The presence of three layers of wallpaper and no paint found under the casing after its removal and used nails found in the right casing of the door indicate that it was installed ca. 1890. The rear porch (HP28) appears to have been constructed about the same time.

Changes in the venting of heating and cooking installations in this room are remarkably numerous. The plaster ceiling has five stovepipe holes, the north wall has one, the fireplace masonry has one, and markings in the wood floor also suggest a circular stovepipe or vent hole from the laundry room below, room 007. An additional cut in the floor, 14" by 16-3/4" is 4'9-1/2" from the hearth and 6'8" from the south window wainscot.

A paint sample removed from the stovepipe thimble directly below the opening into the chimney in the center of room 112 contained the same sequence of paint layers as found on the plaster walls (P735 and 084). These paint layers indicate that the stovepipe was inserted and the chimney probably built at the same time that door 124 was installed. This further supports the contention that the use of this room changed ca. 1890 from a bedroom to a kitchen. The other stovepipe openings in this room probably post-date 1890, but no evidence has been found to document the chronology of their installation.

The floors in room 112 are wider than other Upjohn floors, 8" to 9" in width. They run in a north-south direction and are covered with remnants of paint. Tack holes from grass matting are not visible, given the very irregular surface of the wood floor. This original floor was exposed by the park maintenance staff after removal of a vinyl tile floor and narrow wood flooring. Other changes to the floor include holes for sink and radiator plumbing. Oral history from the DeProse family indicates that Dr. Bascom Birney installed a kitchen sink on the south wall ca. 1917.

Other major changes took place during the residence of Campbell, between 1958 and 1974. West double-arched windows were

removed and replaced with a fixed sash of 24 lights. The height of the opening was decreased. A lower ceiling was installed more than 2' below the original plaster ceiling, probably in response to roof leakage and ceiling deterioration.

Paint samples taken from the cupboard in room 114 (P503) and from the lower cupboard in the north side of window 018 in room 006 (P679) reveal that both of these cupboards were used in room 112, when it was a kitchen. The earliest paint layers on the cupboards--tan, tan, and graining--indicate they were first used in the kitchen, room 006. They had been moved into room 112 by the second time they were grained. The woodwork in room 006 has only one layer of graining; woodwork in room 112 and on the cupboards has two layers of graining.*

The east wall fireplace and brick masonry was exposed by the park maintenance staff with the removal of a brick veneer dating to the Campbell residency. The fireplace opening is 2'6" wide and 2'7" high, rising to a height of 2'9" at the center of a segmental arch, with a depth of 90-1/2". The fireplace back and jambs (excepting 3-1/2" of the outer edge) are suitably covered with black soot. The white marble hearth is in place (61" by 15"), with numerous cracks. The inner hearth brick has been removed.

Finish woodwork is typical Upjohn detailing for secondary spaces--flat surfaces with molded cavetto edges. Door hardware is also typically Upjohn. The plaster cornice matches the cornices found in rooms 111, 114, and 118, all of which are listed in the Upjohn planbook. Wallpaper was used until the end of the 19th century, when the plaster walls were stripped of three layers of wallpaper and painted (see section VI.C.2., wallpaper samples 011, 012, 013).

No evidence of the mechanical bell system has been found in this room.

The preservation and restoration work recommended for room 112 includes the following items:

Infill the brick on the east and west walls.

Remove the ca. 1960 materials on the west wall window, and reconstruct the double window casing.

Reinstall the built-in storage cabinet with modifications, and reconstruct the lower portion.

Install a fireplace mantelpiece, firebox, and hearth marble replacement, either as a reproduction or from site findings.

Extensively stabilize and reconstruct the plaster ceiling and wall.

*Complete description of these cupboards awaits further onsite inspection by the North Atlantic Historic Preservation Center.

Restore the woodwork to its original tan finish (Munsell 10YR 8/2, Benjamin Moore CB-16).

Restore the plaster ceiling and cornice to a finish plaster white coat.

Reproduce wallpaper to match the base layer of paper (pink stripe, WP103) found under the door 124 casing.

Patch all stovepipe openings in the ceiling.

m. Room 113 - Tower Stair

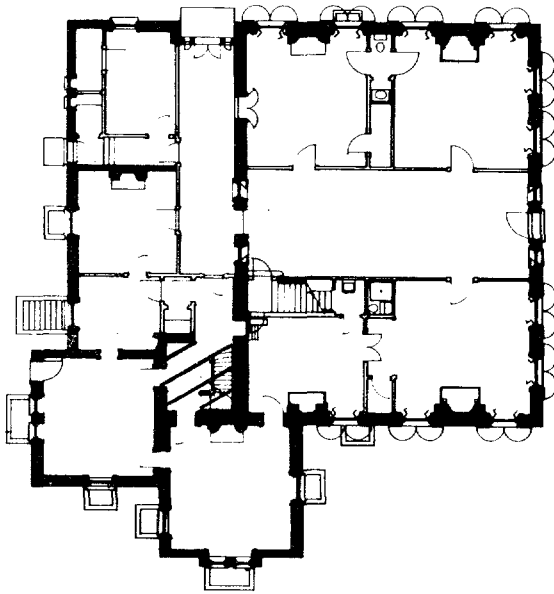

This room originally joined room 117. A board partition (see IP035) divides the space and is described here as a separate room. It functions as the tower stair hall that provides access to the basement and upper floors--room 111 (D126), the library, and room 112 (D125), a bedroom.

Correspondence from Smith Thompson Van Buren to Upjohn documents the staircase design problems that can be seen today (Van Slyck to Richard Upjohn, October 23, 1849, and Smith Thompson Van Buren to Richard Upjohn, November 22, 1849, April 20, 1850, and May 17, 1850,

Upjohn Papers). The stair tread widths had to be foreshortened and curved for the final run along the east wall because of interference with a door opening in the same wall leading into room 109, the breakfast room, in the 1797 house.

The two doors, door casings, and baseboard in the tower stair hall are typical Upjohn work (see IP036). The masonry wall construction of the tower has thicker walls than elsewhere in the ca. 1849 addition, which is evidenced by inner jamb paneling at these doors.

The hardware for doors 125 and 126 has been described under rooms 112 and 111, respectively. Door 121 (in the board partition) is hung with two-knuckle cast-iron butt hinges and has a cast-iron latch with beveled rim. On the back plate of the latch is the marking "D. M. & Co., New Haven," and on the inside is the letter "B." New Haven directories list Davenport and Mallory 1852-57; Davenport Mallory Co. 1861-65. The date of this lock and the absence of evidence of an earlier lock on this door further confirms that it is a later alteration.

All woodwork, except the newel post, banisters, rail, and stairs, was originally painted tan. The newel post, banisters, and rails were varnished; the stairs (treads and risers) were painted light brown.

Plaster walls are white-coated and do not appear to have been painted originally. The floor is laid in a north-south direction; boards vary from 3-1/2" to 9" and were probably left unpainted originally, as in room 117.

No evidence of the mechanical bell system has been found in this room.

The preservation and restoration work recommended for room 113 includes the following items:

Remove a four-hook board nailed on the west wall.

Remove the paint on the walls and floor.

Restore all woodwork except stair treads and risers, newel posts, banisters, and the rail to a tan color (Munsell 10YR 8/2, Benjamin Moore GB-46).

Remove the board partition (also listed for adjoining room 117).

Clean the varnished newel, banister, and rail.

Restore the stair tread and risers to a light brown color (Munsell 10YR 6/2, Benjamin Moore ET-45).

n. Rooms 114/115/116 - Bathroom/Water Closet/Access

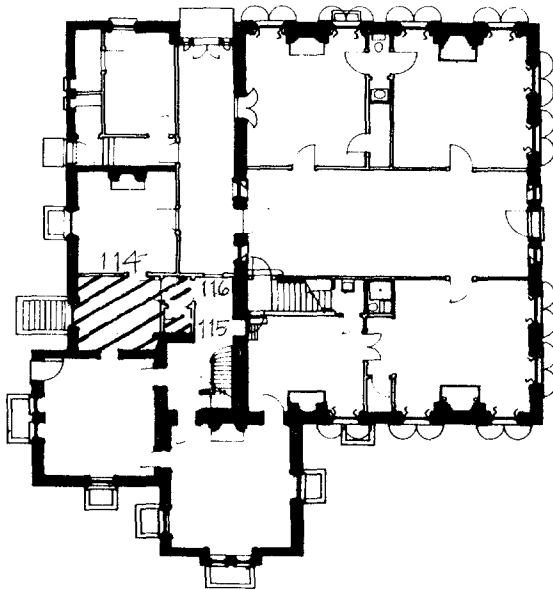

Rooms 114, 115, and 116 are the three rooms that comprised the bathroom. (How the bathroom functioned is described in section IV.C.3.). They are roughly at the center of the west side of the one-story 1849 addition.

Room 114 contained a sink, bathtub, and dressing area. At present, the room may be entered from the bedroom, room 112 (D122); a small access hall, room 116 (D117); the nursery, room 118 (D116); and an exterior door in the west wall (D123). Room 114 has a window in its west wall and a fireplace in its southeast corner.

Room 115 houses the water closet. It was originally separated from room 116 by a bifold wooden door, now hung as door 118. A small oculus window (131) in the east wall of room 114 provides light for this room.

Room 116 is a small hall that joins rooms 114 and 117 and provides access to room 115.

Two drawings for details of the bathroom are recorded in the Upjohn planbook: a full size drawing of the bathroom cornice, and a plan at 1" scale with full-size details for a bathcase. Also illustrated, in a letter of October 4, 1849, to Richard Upjohn from Barney McGuire, a New York City mason who worked at Lindenwald, is the shelf for the bathroom mantel (see IP037). McGuire wrote:

The shelves of the Bath room Mantel will be of the following shape:

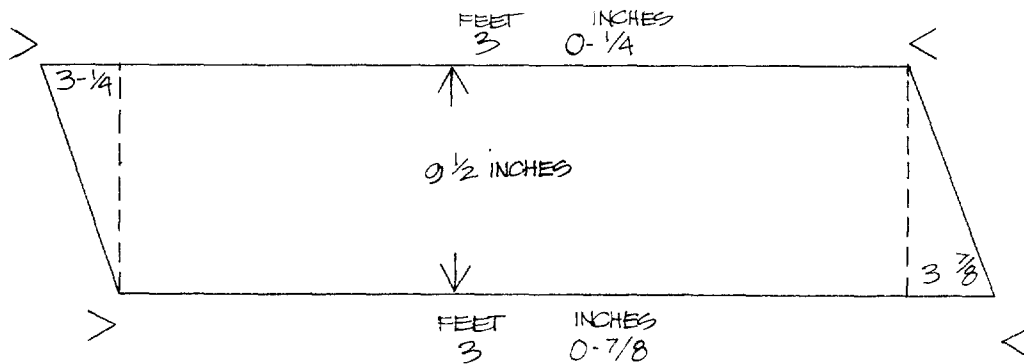

I took the form of the Bathroom Shelf on a board of 9-1/2" wide it runs under the square at one end for that width. 3-1/4 inches and on the other it runs over it 3-7/8 inches (Upjohn Papers).

Correspondence relating to a smoke problem with the fireplace flues during construction of the 1849 addition also mentions the bathroom. Smith Thompson Van Buren wrote to Richard Upjohn on November 22, 1849:

The flues from the Wash-room, Bed-room, and Bath room have smoked so badly that the walls are entirely black, and the ceiling also of the bedroom destroyed (Upjohn Papers).

This documentation firmly establishes the date of the installation of the bathroom at Lindenwald as 1849.

The Lindenwald bathroom appears to have had three major pieces of bathroom furniture: a sink, a bathtub, and a water closet. Only the water closet and the water supply tank for the system remain in their original locations in room 115. The sink and bathtub have been removed from room 114. The bathtub, which consists of a metal tub in a rough wooden frame with dovetailed covers, is in storage at the site; the sink, with the possible exception of its marble top, has completely disappeared.

The locations of the sink and bathtub in room 114 were determined by paint analysis and examination of other extant physical evidence. Paint samples taken from the northwest corner and the center of the east wall of the room contained three fewer layers of paint than samples taken from other areas of the room (see section VI.C.1., paint samples 602, 607, 604, and 005). Along the northwest wall this evidence coincides with a patch, later floorboards, and missing subflooring where pipes from the bathtub probably ran into room 009, the room in which the cesspool is located.

On the east wall the area with fewer layers of paint contains a water supply pipe coming from the water tank in room 115 and a drainage pipe that runs into the soil pipe coming from the water closet. A 1-1/2"-wide black line on the floorboards, outlining an area 2'3" long and 1' 7-1/2" wide, further indicates that the sink stood in this location.

In addition to aiding in determining the location of the sink and bathtub, paint analysis indicates that the bathtub was enclosed by some sort of frame, possibly a drapery frame. It also identifies the height of the tub casing. (For a full description of the evidence found for this casing and frame, see section IV.C.3.).

The fireplace, in the southeast corner of room 114, has a simple marble mantelpiece and surround. Its opening is arched and has a beaded edge. Its firebox, which is made of brick, has a line of firebrick built into its left side, and its floor is 6" below its hearth. This unusual configuration may have been associated with some type of hot-water heater.

The finish work in rooms 114, 115, and 116 is typical for the secondary spaces in the Upjohn addition. Baseboard, door, and window moldings are comprised of flat surfaces with molded cavetto edges. The plaster cornice in room 14 matches the cornices in rooms 111, 112, and 118. The plaster walls and the woodwork in this room were always painted. The ceilings and plaster cornices were not painted originally. In room 115 the original cream paint with blue pigment particles is still on the walls. In rooms 114 and 116 it has been painted over.

Floorboards in the room run in a north-south direction. The width of the floorboards is approximately 3-1/2" to 4". The original floor was uncovered by the park maintenance staff when a later wood floor was removed. The original floor is unpainted.

Door 123, the exterior door in the west wall, and door 116, the door into the nursery (room 118), are later additions to room 114. Evidence found in paint sample 617 indicates that these alterations were probably made when the sink and bathtub were removed from this room and it no longer functioned as a bathroom, ca. 1890. This evidence includes the first layer of paint found on the casing of door 116, a white primer/graining (P618). On all other woodwork, with the exception of the areas covered by the bathtub and sink, the first layer is the cream with blue pigment particle paint. The white primer/graining (P595) was also the first layer found on a piece of metal that was nailed over the drain pipe openings for the sink when it was abandoned. When the door 116 casing was removed by the park maintenance staff in

December 1979, the plaster underneath was found to contain three layers of paint, a cream paint, a cream with blue pigment particles, and a dark green (P617). These are the same three layers that are missing from the samples taken from the areas where the bathtub and sink stood.

Door 123 has no casing, so its date of installation is not as clear, but it seems unlikely that room 114 would have had an exterior door when it was used as a bathroom. Doors 123 and 116 have the cream with blue pigment paint found elsewhere in the room, suggesting that they have been reused. The lock on door 123 was manufactured after 1868 (see section VI.D.1.).

The ceiling in room 114 has also been replaced; originally the room had a plaster ceiling. Lath and broken keys from this ceiling are visible in the attic area above room 114. The current ceiling is a wooden, matched board ceiling. The ceiling may have been water damaged from the use of the room as a bathroom and may have been replaced when the change in use of the room occurred.

One other change in room 114 that appears to have occurred ca. 1890 was the bricking-in of the fireplace opening and the insertion of a stovepipe thimble into this bricked-in area. Paint layers on the plaster covering of this brick suggest this date.

The hardware on the doors in room 114 confirms that doors 117 and 122 are original Upjohn doors. The hinges on doors 116 and 123 are also typically Upjohn, but their locks support the contention that they were reused.

In Room 115 only very minor changes have occurred. When the water closet was abandoned, its cover was closed, the tank drained, and shelves built into the area between the case and tank (see IP038). These shelves are grained, suggesting that this alteration also coincided with the removal of the sink and bathtub and the installation of doors 116 and 123 in room 114. The folding door that separated room 115 from room 116 was also removed and used as door 118. Paint analysis suggests that the original door 118 was reused as door 124. No other alterations, with the exception of repainting, have occurred in room 116.

The exact use of these rooms after they were abandoned as a bathroom, water closet, and vestibule is unclear. Rooms 115 and 116 seem to have been used as closet and storage space. Room 114, which was adjacent to the later kitchen, may have served as a pantry/storage area. This lack of clearly defined use may account, in part, for the paucity of alterations in these rooms and the remarkable state of preservation of the water closet.

Recommended restoration of rooms 114, 115, and 116 includes the following items of work:

Remove door 123 and appropriately infill the brick on the west wall.

Remove the wood ceiling and restore the plaster ceiling and cornice.

Remove door 116 and restore the plaster wall in this area.

Stabilize and reconstruct the plaster wall.

Relocate door 118 to the door 138 opening; relocate door 124 to the door 118 opening.

Remove the paint from the fireplace mantel and surround.

Install the bathtub, with an appropriate wood casing, in the northwest corner of the room. The wood for the case should be the same as, and the design of the case similar to, the water closet case.

Install a sink on the east wall. The sink should be appropriate for the period, be constructed out of the same type of wood, and have similar moldings as the bathtub and water closet cases.

Restore all lead pipe and its wooden casing.

Restore the woodwork and plaster walls in rooms 114 and 116 to their original cream with blue pigment particles finish. This will require special mixing.

Clean the plaster walls and woodwork in room 115.

Restore the plaster ceiling and cornice using a finish plaster white coat.

o. Room 117 - Hall

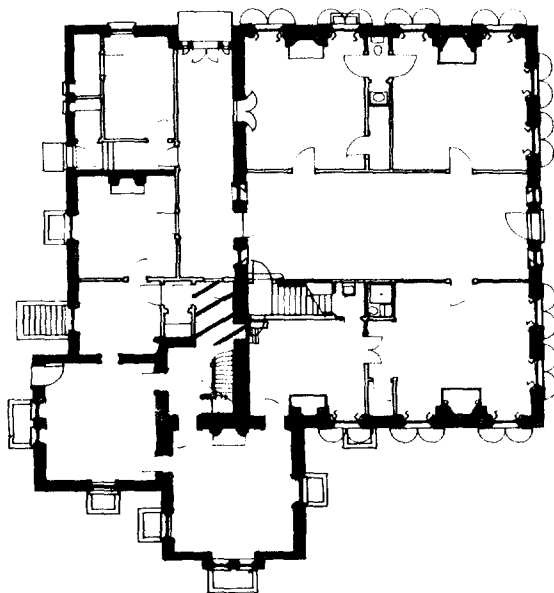

This hall was added as part of the 1849 additions, and although it is currently divided from the tower stair hall, room 113, they were originally connected. The arched opening between rooms 113 and 117 was filled in with a vertical board partition, probably by the Wagoner family in the last quarter of the 19th century. The date of this alteration is supported by paint, hardware, and molding evidence.

The paint samples taken from the partition and door separating rooms 113 and 117 do not contain the first two tan paint layers found on the baseboards in room 117 and on door 119 (compare samples 298 and 294, section, VI.C.1.). The first layer on this door and partition is a graining layer, similar to the graining found in rooms 114, 115, and 116 and associated with the abandonment of the bathroom. The similarities between the two types of graining strongly suggests that the partition was added when the bathroom was abandoned. Hardware on the door, described in detail under room 113, has been dated as being after 1852, probably after 1860. The moldings on the jamb of the door are

shallower and of a slightly different profile than those of the other Upjohn doors (see section VI.B.).

The 1849 north entry hall, room 119 (D118), bathroom passage, room 116 (D118), and the 1797 southwest room 109 (D120) all have access to the hall. Doors and casings leading into 1849 spaces are datable to 1849: casings in the typical double architrave with ovolo and fillets, crossetted at the corners, with base blocks. Doors 118 and 119 are four-panel, with applied molding between recessed panels and rails and stiles. Door 118 into room 116 has been removed and replaced by the bifold door that belongs on the water closet door opening (D138). The original door 118 is probably the current door 124 in room 112. It should also be noted that the "ear" of the door casing into room 116 was considerably foreshortened in the initial construction.

The segmental-arched door casing into room 109 at the southwest corner of the 1797 house is not the typical Upjohn molding. It is a double architrave with base blocks that resemble shims. The composition of molded parts is similar to the Upjohn door installation from room 109 into room 111. The reasons for the difference are best explained in a letter of October 23, 1849, from T.B. Van Slycke, the carpenter, to Richard Upjohn:

. . . I received your favour yesterday with the drawing for the breakfast room door and write to inform you that I cannot get a two foot six inch door in the opening the Largest Size that i can get in is two feet the opening is made close to the partition wall of the old hall which brings the arcatrave close in the corner and in the New hall the Tower Stairs intersects the arcatrave which we could not avoid in consequence of clearing the arcatrave of the Library door we have got the Stairs up to the Second Storey I have given them Seven and a quarter inches rise and nine and one third inches tread as Shewn on the plan (Upjohn Papers).

The jambs of the door casing cover the thickness of the rear (west) masonry wall of the 1797 house. The panels are treated in the same manner as Upjohn doors. The door was originally hung with butt hinges on the room 109 side. The door is of solid walnut construction with an oil finish. The detailing of this door differs from all other Upjohn work but contemporary correspondence strongly indicates that it is part of that construction work.

The baseboards are all typical Upjohn with a short piece of infill on the east wall adjacent to the door casing. This does not have any clear explanation, although the plaster wall at this point has experienced repair or alteration. Irregularities in the plaster surface may be seen in a vertical line near the east wall door casing along one side and squared off at the top. This is probably related to the ca. 1849 infill of the ca. 1797 doorway in this location.

The original finish of the plaster walls and ceiling was the unpainted white-coat plaster. Lower portions of the walls are now painted gray and white. More than half of the ceiling has been patched and, most likely, totally replastered. Cracks on the west wall indicate a downward movement of a short portion north of the board

partition. One very visible, vertical crack occurs at the point where the wall meets the masonry arch. It was caused by deflection of the floor joists that support the frame west wall.

Floorboards are finished tongue-and-groove, 3-1/2" to 4" in width, and run in a north-south direction.

No evidence of the mechanical bell system has been found in this room.

The preservation and restoration work recommended to restore room 117 includes the following items:

Replace the plaster ceiling patch with a closer match in texture and evenness.

Remove the board partition and door.

Remove the folding door and replace with the original door.

Restore the unpainted plaster wall and ceiling finish.

Restore all painted wood finishes to a tan color (Munsell 10YR 8/2, Benjamin Moore CB-35).

Stabilize the thresholds if required.

Check the floor joists in relation to downward movement, and monitor cracks.

p. Room 118 - Nursery

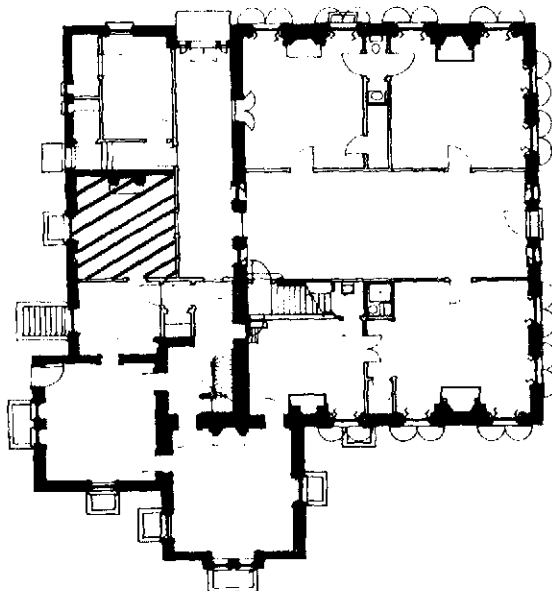

Room 118 is directly to the west of the 1797 central hall, room 105, and between the small hallway, room 120, on the north and the bathroom, room 114, on the south. The entry for May 30, 1849, in Upjohn's planbook lists "cornices of hall, nursery, bedroom and bathroom." Having identified the hall, bedroom, and bathroom, Room 118 is the only remaining space with a cornice molding. Barney McGuire stated in a letter of October 4, 1849, to Richard Upjohn that the width of the chimney breast in the nursery was 5'4". This corresponds to the present condition in room 118.

It may be accurately stated, therefore, that the intended use of room 118 was as a nursery.

Access for room 118 is from the Upjohn entry hall, room 119 (D115). A door opening in the south wall leads to room 114, the Upjohn bathroom (D116). There is a fireplace projecting into the room on the north wall and one window (116) in the west wall.

The major changes in this room occurred with the insertion of door 116 in the south wall, leading into room 114. Visible evidence included a flat board casing and a door with its "back side" of plain recessed panels facing room 118. The door is not consistent with the typical Upjohn doors for similar locations, which have panel molding on both sides. There are a greater number of paint layers on the door (P628) than on the casing and a graining layer that does not appear elsewhere in the room. The base cream layer has the blue pigment particles found in room 114. The door casing does not include the original cream and light brown layers found elsewhere (P306, P672).

This door casing (D116) was removed during 1980 February investigations. One layer of wallpaper (WP014) was exposed that corresponds with the faint surviving patterns on the walls. (The white-coated plaster walls were stripped of nonhistoric wallpaper by the park maintenance staff in 1978).

Both the design and paper type have been dated to the original 1849 period of construction. The slight difference in the number of paint layers found on the door casing compared with original woodwork suggests that this change was made during the late 19th century, probably at the same time the bathroom was abandoned. Paint evidence found on the room 114 side of this door, described in the narrative of that room, strongly suggests this date.

The most significant evidence of furnishings in this room relates to a very large object that must have greatly influenced the form of the room. After wallpaper removal by the park staff in 1978, the profile marks on the south and west plaster walls became visible. This "furniture" was 2'6" in depth, approximately 4'10" in width along the west wall, and stood approximately 10'8" in height, from the wood floor. Except for an overhanging cornice molding at the top, it appears to have been straight-sided. An unfinished floor surface corresponds in size, and no wallpaper ghosts are visible on the plaster walls.

Minor changes may be found at the chimney breast on the north wall. A later stovepipe hole is near the center, and the fireplace masonry appears to have been altered. The existing jambs and fireback consist of very loose brick of different sizes and irregularly laid. The fireplace opening size and the segmental arch construction is similar to the room 112 fireplace. The white marble hearth is also very close in size. The absence of such infill masonry in the comparable bedroom fireplace, together with its condition of irregular design and deterioration, strongly implies a later date.

The typical Upjohn design for the white marble mantelpiece, its cast iron frontal framing piece, and details of construction such as inner hearth brick being perpendicular to the marble hearth should be valuable for the reconstruction of room 112 fireplace hearth and mantelpiece.

Finish woodwork is typical Upjohn detailing for secondary spaces. The hardware on door 117 consists of an electroplated cast-iron mortise lock and five-knuckle eight-hole 4" by 4" cast-iron butt

hinges. Both of these have been dated to 1849-1850. Door 116 is also hung with five-knuckle eight-hole 4" by 4" cast-iron butt hinges. Since paint evidence suggests that this door was installed after 1850, these hinges, combined with additional paint evidence, confirm that this door was reused. (See section VI.D. for documentation of dates assigned to hardware.)

An additional floor layer was removed by the park maintenance staff in 1978 to reveal a painted wood floor of 3" to 4" wide boards laid in a north-south direction with a mitered framing at the hearth. Chemical testing of the paint in a sample removed from this floor indicated that originally it was not painted. None of the paint reacted to NA_2S , as all other Upjohn paint did (P632). The baseboard area covered by the later floor and possibly a quarter-round molding contains four layers of paint (P629). Additional layers of blue, white, and white found on the upper portions of baseboards must necessarily date after the later floor installation. This difference in paint layers suggests that the later floors were installed early in the 20th century.

No evidence of the mechanical bell system has been found in this room.

It is recommended that restoration of room 118 include the following work:

Remove the fireplace infill, with attention to the metal hooks that secure the east iron frame. Dating of the frame should be possible when brick removal exposes the attachment location.

Reconstruct the stud and plaster wall at the door 116 location.

Stabilize the remaining 25 percent of the plaster ceiling.

Reconstruct of 75 percent of the plaster ceiling on original lath in situ. (Note: Damage caused by roof leakage problems.)

Make miscellaneous plaster wall repairs, including removal of the chimney breast stovepipe thimble.

Restore the original woodwork to a cream color (Munsell 2.5Y 9/2, Benjamin Moore GB-30).

Clean the cornice and ceiling area to be left unpainted.

Reproduce and install wallpaper (WP014).

Remove all paint from the floor.

Study further to determine the southwest furniture piece and the floor markings in the northeast corner.

q. Room 119 - Hall

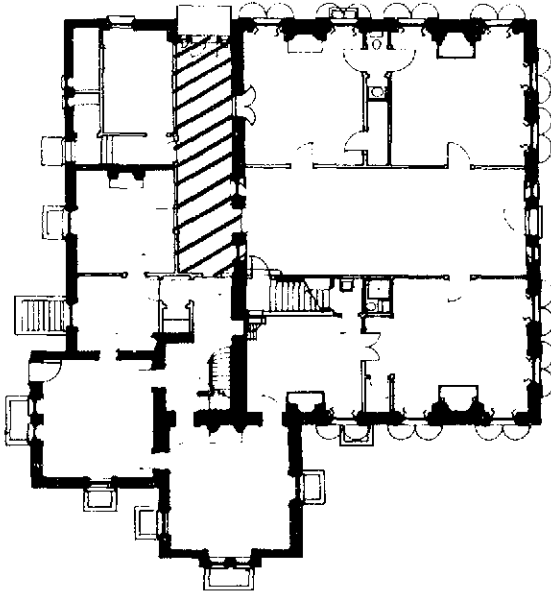

Room 119 is an entrance hall approximately 33' in length along the northern portion of the west wall of the 1797 house. This hall was added as part of the 1849 work. Entry from the exterior is through a double-door opening in the north wall (D109). Access from this hall is provided by two doors in the west wall--one to room 120, a hall (D114), one to room 118, nursery (D115)--and by a former exterior door opening in the east wall (D108) leading into the central hall, room 105.

The function of this room as an entrance hall is clear. It is not known, though, whether it was used primarily by Smith Thompson

Van Buren's family or also as the main entrance for all guests. With the change in the use of room 105 as an entry and stair hall to include dining, it is conceivable that the north entrance hall could have taken on the main entry function for both households.

Change in the original appearance of this room has occurred as a result of deterioration of the terneplate roof and gutter drainage system. Plaster patches, probably dating within the last 20 years, may be seen on the west wall over door 114, on the north end of the ceiling, and on the east wall. Entire sheets of gypsum board replaced original plaster on the skylight walls. Ceiling patches fell during 1978 roof repairs. Removal of a gypsum board infill on the east wall in 1979 exposed a brick-filled ca. 1797 opening with a flat lintel and the pre-1849 paint finishes on the original exterior brick wall. The brick and mortar infill has been dated to the 1849 construction period, details of which include a continuous baseboard along this wall. The ca. 1797 painted brick surface was scored to receive plaster, but the 1849 brick masonry was able to receive the plaster finish directly.

Documentary evidence compared with physical evidence suggests that the idea of a glass door in the east wall was not executed. Several letters from Smith Thompson Van Buren to Upjohn in 1850 requested a drawing for a glass door to improve the lighting in the central hall (room 105) of the ca. 1797 house. On May 5 he wrote, "You will bear in mind that it should be constructed with a view to the assaults of children as high up as they can reach." And on July 27, it should be "an ordinary door (painted like the other woodwork in the Hall--instead of Blk. walnut) . . . with the Glass of white plate containing 4 large panes, & a border only such as you have drawn, of stained glass" (both letters in Upjohn Papers). Dimensions given for the "present door" in the May 5 letter match those of the existing door, which is a paneled wood door. Despite Smith Thompson's concern over his father's complaint that he had made the central hall dark, it does not appear that a glass door ever was built.

On the east wall, south of the infilled door, a register for the ca. 1854 hot-air heating system was added.

With the exception of door 108 and windows 128 and 129, all the woodwork detailing in room 119 is typical Upjohn design for primary spaces. The moldings that comprise all of the door casings are the same, large ovolos and fillets. Although the casing of door 109, the north entry door, is of the same moldings as the casings of doors 114, 115, and 119, its design, like its use, is different. Unlike the other doors, its opening is a semicircular arch with double doors and sidelights.

The double doors follow the semicircular arch of the casing, and the fixed sash of the sidelights contain four lights each with horizontal muntin divisions only (see IPO39). There are also six lights in a semicircular-arched transom above the door casing. The wood shutters for the sidelights are not found elsewhere in Upjohn's work. They are hinged with two-knuckle lift-off butt hinges, have recessed panels with moldings on the exterior and flush-and-beaded panels on the interior. Baseboards are of typical Upjohn design for primary circulation spaces and are also found in rooms 111, 113, and 117.

Door 108, which connects the 1849 hall (room 119) to the ca. 1797 hall (room 105) appears to be of ca. 1840 Van Buren origin (see IPO40). Windows 128 and 129, the fixed window sash flanking door 108, also appear to date to ca. 1840. These would have been exterior windows and an exterior door before the Upjohn addition was built. Both the windows and the door have different moldings from the other woodwork in the room, and paint samples taken from these elements indicate they include four earlier cream paint layers than the Upjohn work (see section VI.C.1., paint samples 314, 316, 317, 318).

Most of the hardware in room 119 can also be dated to Upjohn. Doors 108, 109, 114, 115, and 119 are hung with ca. 1849 cast-iron butt hinges. Doors 114, 119, and 109 have ca. 1849 electroplated cast-iron mortise locks. Door 115 has a silver-plated cast-iron mortise lock (pre-1850); this lock appears to be reused.

Plaster walls have a base layer of pale blue paint, a second scheme of pale green on the lower 6'3" and rust brown on the upper 4'4", and surface treatment of plaster infill. The original plaster wall finish is not known, but the absence of early paint in a rather formal room suggests that it was wallpapered. The plaster cornice profile matches other Upjohn work in rooms 111, 112, and 114.

The wood floorboards, which are currently varnished, are 3-3/8" to 4" wide and laid in a north-south direction. Originally the floor appears to have been unfinished and possibly carpeted, as was room 105.

An additional feature of this hall is a monitor-type skylight at the south end of this room. This skylight is described in detail in section IV.A.14.

No evidence of the mechanical bell system has been found in this room.

The preservation and restoration work recommended for room 119 includes the following items:

Stabilize and reconstruct the plaster ceiling, walls, and skylight walls.

Restore the woodwork to a cream color (Munsell 2.5Y 9/2, Benjamin Moore GB-30).

Restore the walls using a finish plaster coat. This will require additional research to determine how the walls were finished.

Remove the varnish from the wood floor.

r. Room 120 - Hall

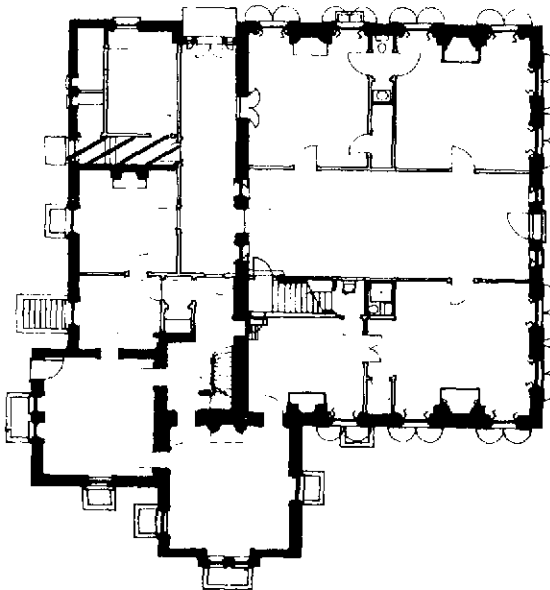

This hallway in the 1849 addition runs in an east-west direction. Before other door openings were added in the latter part of the 19th century, this hallway provided the only exit from the first floor to the west, or back, side of the house. The space is perpendicular to and midway along the west wall of the large Upjohn entry hall (room 119). Access from other parts of the house is through room 119 only (D114). This small hallway, in addition to providing an exit to the exterior, provides access to room 123, a bedroom (D113), and room 121, a privy (D121).

Changes in this hallway are primarily a result of roof deterioration. More than 50 percent of the plaster ceiling is missing because of water damage. Drainage problems along the west wall gutter system also caused masonry settlement. The diagonal cracks in the west wall plaster can attest to this problem.

Excepting these minor fabric changes, the hallway appears today in essentially its original form. Finish woodwork matches other Upjohn work of secondary spaces. The west door casing (D112) with its segmental arch matches the more decorative ovolo and double architrave used by Upjohn for primary spaces. There is no cornice treatment, and the surviving walls and ceiling remain unpainted. The floor of 3"- to 4"-wide boards runs in a north-south direction at the east end, then descends three steps to boards that run east-west. Its existing unpainted condition also is assumed to be original. The hardware for the doors in this room is discussed in the description of the rooms into which they lead.

No evidence of the mechanical bell system has been found in this room.

The preservation and restoration work recommended to restore room 120 includes the following items:

Stabilize and reconstruct the plaster walls and ceiling to match the original in color and texture.

Patch the floor holes.

Reset the exterior door jamb casings.

Restore the wood finish to a cream color (Munsell 2.5Y 9/2, Benjamin Moore GB-30).

s. Room 121 - Privy

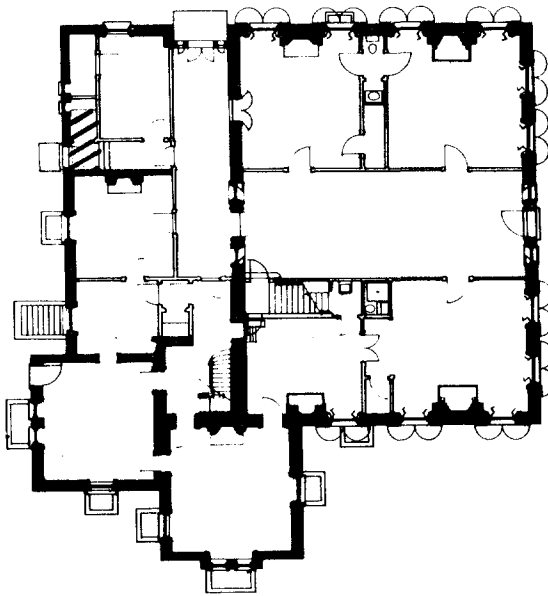

This privy has remained in its original form since ca. 1849 (see IP041). It has a wood-encased seat above a stone-lined privy well. The built-in seat is composed of one horizontal, recessed panel with molding on the vertical front and four similar panels with the cyma recta molding on the top or horizontal surface. One larger panel on the top is butt-hinged for the seat opening.

There is an arched window opening with a four-light casement sash in the west wall. All walls are now and were historically of unpainted plaster. The mortises for eight-hole 4" by

6" butt hinges mark the location for a door. The floorboards are 5" to 6" wide running east-west.

The preservation and restoration work recommended for room 121 includes the following items:

Remove a board with hooks on the east wall, if it is found to be nonhistoric.

Replace the door (111).

Restore the painted wood surfaces to a cream color (Munsell 2.5Y 9/2 Benjamin Moore GB-30).

t. Room 122 - Storage

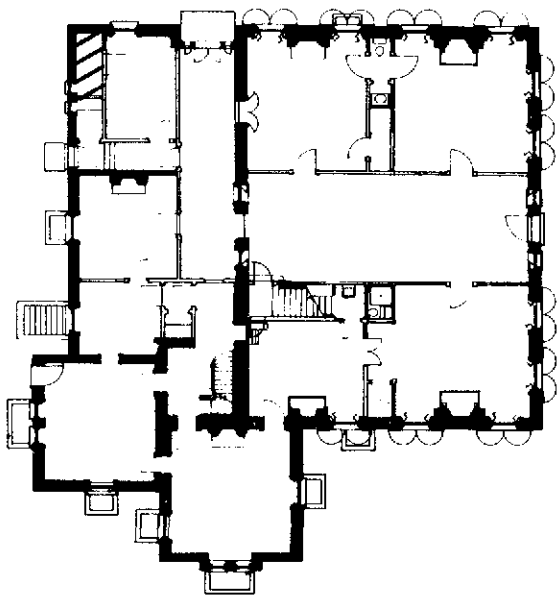

This closet occupies the northwest corner of the ca. 1849 addition. It is entered from a small bedroom, room 123 (D110).

There does not appear to be a built-in or attached system for hanging clothes or for storage except for one shelf at the north end. Neither the shelf nor several ledger strips appear to be original.

L-shaped sections of sheet metal have been nailed to the angle between baseboard and floor along the west wall.

There is one arched window in the west wall with a four-light casement sash. The plaster ceiling and walls are whitewashed. The finish woodwork is of typical Upjohn detailing. Door 110 also has typical Upjohn hardware.

The floorboards vary between 4-1/2" to 9" in width and are laid in a north-south direction. The floor is unpainted and should remain so.

The preservation and restoration work recommended to restore room 122 includes the following items:

Remove molded ledger strips secured to the north and west walls for further investigation; replace these ledger strips with strips matching those on the east wall.

Restore the plaster walls and ceiling to a whitewash finish.

Restore the woodwork to a tan color (Munsell 10YR 8/2, Benjamin Moore CB-35).

Remove the metal patch along the west wall; assess and repair any deterioration to which it may be related.

u. Room 123 - Chamber

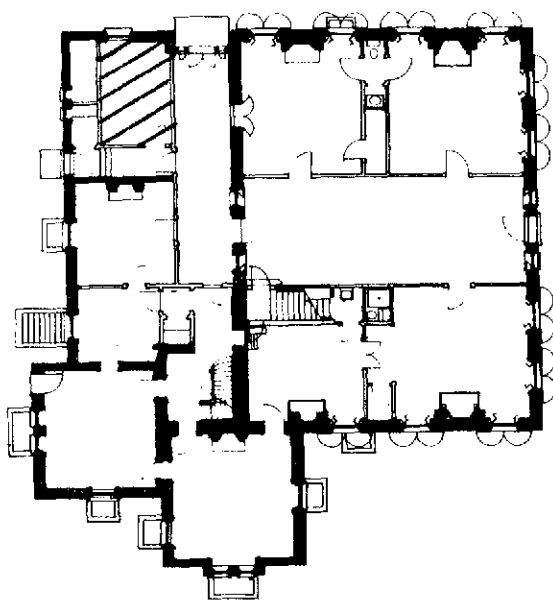

This is a small, rectangular room at the north end of the Upjohn addition, which is entered from a small hallway, room 120 (D113), and has a large, attached closet (room 122). The simplicity and size of the space suggest a children's or servants' bedroom. No plans or detail drawings are listed in Upjohn's planbook for this room that would support a specific function.

Except for several minor repairs that are needed, room 123 is in its original form. There is no fireplace or cornice molding. The finish woodwork for two door openings, one north wall window opening, and the baseboards is

typical secondary-space Upjohn detailing. The hardware on door 113 is also typical Upjohn hardware, five-knuckle eight-hole 4" by 4" cast-iron butt hinges and an electroplated mortise lock. The wood floor runs in a north-south direction, is of 3"- to 4"-wide boards, and is currently painted blue-gray. Originally the floor was unpainted. No tack marks are visible for grass matting, although they may be obscured by the paint finish. It appears that the original walls were either whitewashed or wallpapered. No samples of wallpaper have been found.

No evidence of the mechanical bell system has been found in this room.

It is recommended that restoration of room 123 include the following work:

Stabilize the plaster at the northeast corner masonry job.

Repair the sliding shutter.

Restore window and door casings to a tan color (Munsell 10YR 8/2, Benjamin Moore CB-35).

Restore the plaster walls and ceiling using whitewash.

Remove the paint from the wood floor, and research former floor coverings.

3. Second Floor

a. Room 201 - Guest Chamber

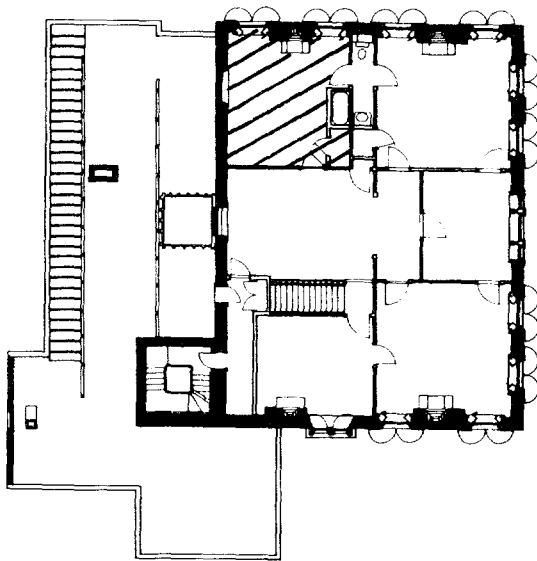

This second-floor bedroom is in the northwest corner of the ca. 1797 house. Access is from the central hall, room 206 (D209). A door opening in the north end of the east wall (D207), leads to a closet, room 203, and also permits passage through to the northeast bedroom, room 205. There are two windows (210 and 211) flanking a chimney breast in the north wall and a cabinet in the west wall location of a ca. 1797 window opening (W212).

There are no documentary references for room 201. The second-floor bedroom mentioned in the letter of May 15, 1841, from Martin Van Buren to Harriet

Butler has not been distinguished as being either room 201, 205, or 209 (Downs Collection). The two remaining bedrooms, rooms 208 and 210, have been identified through this correspondence and physical evidence as being the "temporary Bed Room" and "Martin's Bed Room," respectively. In the May 17, 1841, letter from Harriet Butler to Martin Van Buren, references to the second-floor bedroom that required "a little more expensive" wallpaper and that might be occupied by guests such as young Harriet Butler herself suggest a room of finer detailing than room 201 (Van Buren Papers, CCHS). From the available documentation, however, it cannot be concluded whether room 201 was used as a family or guest bedroom.

The earliest change that has been noted in room 201 was the removal of all chair rails. The evidence consists of horizontal plaster infill at an approximate height of 35". This change occurred in all major rooms of the ca. 1797 house and has been associated with ca. 1840 work of Martin Van Buren. The case supporting this date and the association with Van Buren is well documented in rooms 101, 105, and 109 (see section IV.B.2).

The west window was bricked in when the roof of the ca. 1849 addition covered this area (see IP042). The shutter recesses of the splayed window jambs were covered over with vertical boarding, as were the sash tracks. Shelves, doors, and a typical Upjohn molding were installed. All of this ca. 1849 material has been confirmed in date by paint analysis (see section VI.C.1., paint samples 554 and 555).

The hot-air heating system introduced in the north half of the 1797 house sometime after 1854 included a register in the south portion of the east wall baseboard in room 201 (see section IV.C.2. for a complete description of the heating system). This circular register is mounted in a white marble frame. The rectangular opening in the upper portion of the stud wall on the south may be of the same date or

earlier. This opening, similar to one in the south wall of room 205, may have been for the routing of a stovepipe from room 206 across the ceiling of room 201 into the north chimney flue. Cut nails dated between the late 1830s and 1850 were found in the opening of room 205 (see section VI.D., nail A062). Such a method for heating room 206 may have been used by Van Buren prior to the ca. 1854 introduction of ducted hot air through a register in door 210. Another hypothesis suggests that the opening may have served to facilitate air movement after installation of the furnace. The remaining changes that occurred in room 201 relate to plumbing work of the 20th century. A sink and towel rack, initially on the north end of the east wall, were moved into a separate bathroom, room 203, by Campbell in the 1960s. The location of the sink in the bathroom can be seen by an outline of its backsplash on the plaster wall. This sink, probably installed by the DeProsse family, was in place when the walls were painted with a pink calcimine.

The greatest alteration to room 201 was made when nearly 6' of the east wall was removed and the portion of the east wall south of door 207 was relocated farther to the west. This change took place during Campbell's residency and was made to accommodate a tub in room 203 and a new closet, room 202. The ceiling was lowered at the same time, new wallpaper and electrical outlets were installed, and the floor was sanded and varnished. All of these changes have been dated to the ca. 1960 work of Campbell on the basis of the modern materials and oral history. All of this work was removed by the park maintenance staff in 1978. The 1976 measured drawings by Schafer show the layout of this area before their removal.

With the exception of window 212, all woodwork in room 201 dates from the original ca. 1797 construction. The double architraves of door and window casings include a cavetto molding also used on the windows in rooms 205, 208, and 209 and used on the majority of the doors both in original and replication work. The doors and hinged interior shutters are also typical for the ca. 1797 work. The six-over-six window sash have been dated to the ca. 1840 remodeling by Martin Van Buren on the basis of lock hardware, comparative size of lights with the surviving upper sash of window 203, and muntin profile. Baseboards are plain with an ovolo molding at the upper edge affixed over the plaster scratch coat, and with brown and finish coats resting on the upper edge. The double architrave with ogee molding used on the window 212 casing was also used in other ca. 1849 Upjohn work on window 215/216 and door 128.

The typical ca. 1797 wood mantelpiece has a molded architrave surrounding an off-center opening, plain frieze with curved outer ends, an overhanging cornice, and two recessed vertical panels with integral molding to the west of the fireplace opening. This mantelpiece is identical to the one in room 210 except that the asymmetry is reversed. Both are smaller and less detailed than the mantelpieces in the front bedrooms, rooms 205 and 209. The firebox masonry and hearths appear to be unaltered.

Paint analysis reinforces the molding analysis in assigning a ca. 1797 date to the woodwork (except W212). Most elements share a base layer of light yellow followed by multiple creams and whites

(P335). Baseboards differ in having a first-finish layer of blue on the flat portion only. Elements comprising window 212 have base layers of cream corresponding to layers 4/5 on samples from ca. 1797 work (P338).

Walls have a finish white coat of plaster and currently show some areas of pink calcimine. Modern wallpaper was removed by the park maintenance staff during removal of all ca. 1960 Campbell work. Evidence for the Van Buren period wall finish is derived primarily from the fireboard. The original base layer of paper on the fireboard is gray and white with pink and yellow flowers. An appropriate stylistic date, together with a matching fragment found behind the window 212 casing, supports the use of this paper before ca. 1849.

The floor consists of tongue-and-groove boards, 1-1/4" thick, laid in a north/south direction. An alteration of unknown date and purpose consists of an infill area, 11-1/4" wide by 2' in length immediately south of the hearth. Infill boards are secured with cut and wire nails. The gray floor area under the ca. 1960 tub is dated to the late 1940s. Oral history has related this floor paint, particularly in rooms 109 and 206, to the use of the house as a nursing home. The floor finish found in the remaining area of room 101 is the result of sanding off the paint and varnishing and is dated to Campbell, ca. 1960.* There are tack marks on the floor, but it is not possible to discuss a pattern than would clearly indicate grass matting or carpeting.

Door hinges for door 207 are typical HL hinges from the ca. 1797 period. Shutter hinges are also typical butts, and there is no evidence of shutter pulls. The ca. 1849 doors for window 212 hang on butt hinges. Locks for door 207 and door 209, although different, have both been dated to a ca. 1840 installation. The carpenter-type lock on door 207 matches one used on door 206 and the Green & Borad rim lock of door 209 matches those on doors 201, 203, 204, 215, and 217 (see section VI.D.).

A mechanical bell system included a bell crank on the east face of the chimney breast. The wires from this bell crank ran down into room 101, exposed on the east side of the chimney breast. It ran through the floor in room 101, into room 001, and connected with a bell in room 005, the servants' dining room (see section IV.C.5.).

It is recommended that restoration of room 201 include the following work:

Reconstruct the central portion of the east wall.

Repair and stabilize the plaster wall and ceiling in areas where the ca. 1960 lowered ceiling intervened and above window 212 where roof deterioration caused water leakage.

Replace missing butt hinge parts, and hang window 212 doors.

*Other rooms that were sanded and varnished ca. 1960 include rooms 104, 106, 109, 111, 119, 205, and 210.

Fill the small south wall opening.

Reproduce the fireboard paper and border for use on the fireboard and throughout the room (WP017).

Restore the ceiling and cornice finish to a white calcimine.

Restore all woodwork to a cream color (Munsell 2.5Y 9/2, Benjamin Moore GB-30).

Remove the 20th century sash locks, and replace them with reproductions.

Reinstall the ca. 1854 hot-air register and marble frame.

Install a bell system wire and reproduction crank on the east face of the chimney breast.

b. Rooms 202/203/204 - Closet/Bathroom/Closet

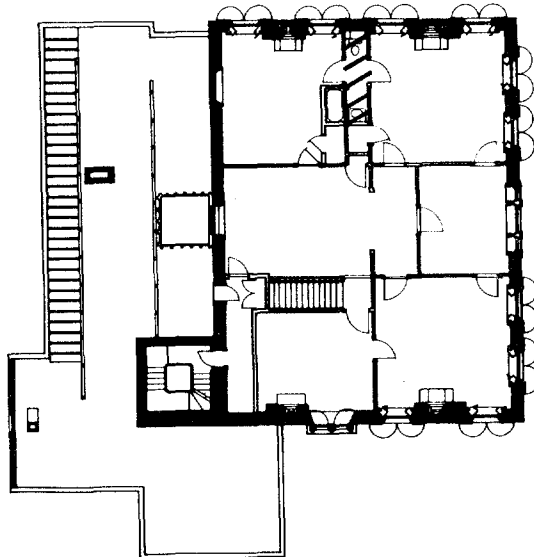

Room 202 was a closet built in the southeast corner of room 201 by Campbell, ca. 1960. This enclosure was removed by the park maintenance staff in 1978.

Rooms 203 and 204 are secondary spaces between the major north bedrooms, rooms 201 and 205. Room 203 (north of room 204) was enlarged to receive a bathtub by relocating a portion of the west wall farther west. This ca. 1960 work included the closet construction that created room 202. Plumbing for the toilet and sink fixtures in room 203 has been attributed to the DeProse family through oral history and the 1938 DeProse drawings.

This installation included the horizontal boards on the north wall, a cast-iron vent pipe, and gray painted floorboards. A change in the casing of door 207 also occurred sometime during the DeProse or Campbell work. The physical evidence consists of a different molding from door 206 on the room 201 side of door 207 and the use of wire nails. All fixtures and the south wall were removed by the park maintenance staff in 1978.

Two additional changes included the relocation of the south wall and door 206. The 1938 DeProse drawing shows the south wall adjacent to the north casing of door 205. This location was only possible after the stairs were removed from room 204 ca. 1849. Faint ghosts on the east plaster wall suggest an earlier partition wall approximately 2'7" from the south casing of door 206. This location corresponds to the top of the attic stair and to the end of the wallplate at the floor.

Dating the relocation of door 206 is problematical. The following evidence is pertinent:

The typical 1797 wall construction, including a large plate with studs tenoned into it, was exposed by the removal of an east wall baseboard to reveal a gap in the plate immediately south of door 206.

The typical 1797 threshold area with a continuous flat board (flush with the finish floor level also as seen in room 208, north wall) exists in this area of the plate gap.

This threshold area ends at a midpoint of the present door 206 and is evidenced by the butted ends of two floorboards, the north board being wider than the south.

This evidence suggests that the north and south casings of door 206 were originally located south of the present locations.

Door 206 hangs on 3-1/2" by 2" five-knuckle, six-hole hinges that have been dated to ca. 1840.

Lock 206 has been dated between land 1836 and 1850.

Thus, the most likely date for the relocation of door 206 is ca. 1840.

Room 204 (immediately south of room 203) originally housed the stairs that led from the second floor to the third floor of the ca. 1797 house. Ghosts on the east plaster wall north of door 205, a cut in the west wall baseboard, and marks in the ceiling and floor in room 302 have provided the evidence for such stairs in this room. The opening in the ceiling was the full width of the room and 4' long. Treads appear to have been 6-1/2" (7-1/8", including nosing), and risers were a steep 10-1/4". Door 210 in the south wall provided entry from the central hall, room 206.

Removal of the stairs took place as part of ca. 1849 alterations by Upjohn. Redesign of the third floor included a partition wall that blocked the stair opening. New access to the third floor was designed as part of the tower stair and two "new" rooms, 211 and 307, derived from room 210 and the attic of the ca. 1797 house.

Removal of the stair made possible the introduction of ductwork for the ca. 1854 hot-air heating system. A duct from room 103 below rose to the south end of room 204 and branched into rooms 201, 205, and 206. The register for room 206 was in the ca. 1797 door that originally led to the attic. This ductwork was concealed within the portion of a cabinet in the south area of room 204. This cabinet now extends to a height of 7' 5-1/2" and is capped by a wood shelf. Construction of this enclosure probably occurred soon after the installation of ductwork. Dating the use of the enclosed space above the ductwork as a closet with access from door 210 of room 206 is uncertain. Shelves are supported by ledgers nailed with cut nails (similar to the closet in room 211) and there is one layer of paint.

Several possibilities exist for the use of rooms 203 and 204 following stair removal and before installation of the heating system. The rooms may have been partitioned off so that room 204 formed a closet with access from room 206. The space may have continued in use as one closet before and after the introduction of ductwork. And, eventually, door 205 from room 205 was added in the east wall of room 204. The dividing partition for rooms 203 and 204 may have existed previously or may have been added at that time.

Recommended restoration of these rooms will include the following items of work:

Remove all plumbing pipes, north wall boards, and horizontal boards on the south partition.

Replace the floorboards.

Reconstruct the middle portion of the west wall (also listed under room 201).

Install reproduction molding on door 207 to match that in room 201.

Replace several baseboards.

Clean and renew the whitewash wall finish.

Restore the woodwork to a cream color (Munsell 2.5Y 9/2, Benjamin Moore GB-30).

c. Room 205 - Guest Chamber

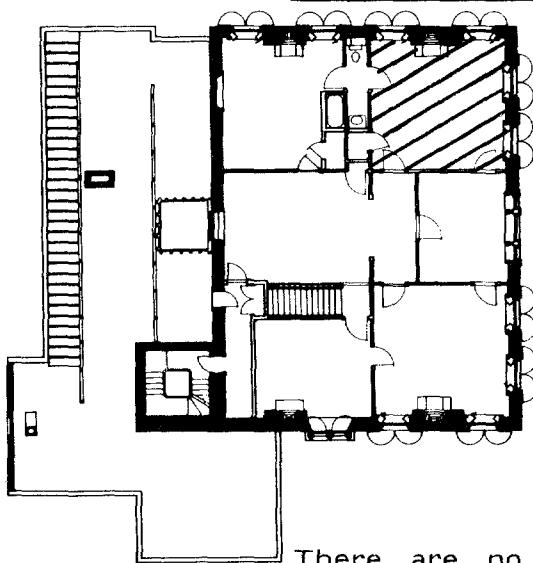

This second-floor bedroom is in the northeast corner of the ca. 1797 house. Primary access is from room 207 (D204), and another door opening in the south wall (D203) allows passage from room 208. Two door openings in the west wall (D205, 206) provide access to closet space. The opening at the north, into room 203, also permits passage into room 201. There are two windows in the east wall (W206, 207) and two windows in the north wall (W208, 209) flanking a chimney breast.

There are no documentary references that may be conclusively related to room 205. There is, however, the possibility that the second-floor bedroom mentioned in the May 1841 letters between Martin Van Buren and Harriet Butler is room 205 (Downs Collection and Van Buren Papers, CCHS). Rooms 208 and 209, having been identified through this correspondence and physical evidence, may be eliminated. George Alfred Townsend in an 1891 article for a New York newspaper

stated that room 209 was Martin Van Buren's bedroom (quoted in Collier 1914, 376-77). This use would eliminate room 209, since the correspondence refers to a guest use for the second-floor bedroom being discussed. Room 201 seems an unlikely choice because of its comparative lack of detailing and daylight. The mantelpiece in room 205, particularly, received greater attention in its design than the other three second-floor bedrooms. From this limited correspondence, however, the designation of room 205 as a guest bedroom, possibly used by young Harriet Butler, remains inconclusive.

Changes in room 205 consisted of the addition and relocation of doors on the south and west walls. Physical evidence of change at the south wall includes an outline of an earlier door opening in the plaster wall between doors 203 and 204 (see IP043). The same outline appears on the opposite side in room 208. Temporary removal of the baseboard in room 208 and the thresholds for doors 203 and 204 has exposed two types of construction: the original door location has a continuous floorboard in the threshold area ending at the stud framing, which sits directly upon a plate; doors 203 and 204 do not have the continuous floorboard in the threshold but rather are shimmed to support a threshold that rests on the adjacent flooring. This change has been given a pre-Van Buren date because of chair-rail infill across the earlier door opening. That is, a chair rail was installed across the former door opening when it was closed off, and subsequently the chair rail was removed and the scars plastered when all other chair rails were removed (see IP044). Based on evidence primarily in rooms 105 and 109, removal of the chair rails has been dated to ca. 1840. The casings, doors, hinges, and chromochronologies for the later openings, doors 203 and 204, match other ca. 1797 work and may be assumed to have been reused. The baseboard length between the later door openings does not appear to have the ca. 1797 base layer (P067). Lath nails used in the earlier doorway infill can be dated to ca. 1810 and suggest that the alteration of this doorway may be one of the changes attributed to William Van Ness by Martin Van Buren. (These lath nails are cut with diagonal burrs and crude machine-made heads.)

The second door relocation also occurred before 1840 and, together with the door relocation and addition on the south wall, was probably part of the many subtle changes authored by William Van Ness between 1804 and 1824.* This north opening, door 206, on the west wall was moved less than 2' to the north. The evidence for the change is indeed subtle and includes threshold framing and lath indications on the room 203 side (fully described under that room), a slight variation on the typical 1797 double architrave casing (matching D202), a door hung on butt hinges rather than the wrought HL hinges used on other ca. 1797 doors on the second floor, a molding variation on the door itself, and wallpaper behind the casing (WP018). This change may have related to the placement of furniture. It is similar to the relocation of door 216 between rooms 209 and 210.

*Martin Van Buren's letter to Gorham A. Worth, April 9, 1849, states that "William P. came and disfigured every thing his father had done." Martin Van Buren Papers, LOC.

We do not have strong evidence for dating the addition of door 205 at the south end of the west wall. It is known that the door could not have been added until ca. 1849 when the stairs which ascended from the second to the third floor in a northerly direction immediately behind door 205 were removed. Removal of the stairs, however, did not require access from this area of room 205. Access from room 205 into the closet, room 204, was still possible from room 206. Physical evidence from door 205 and its casing does not seem to be typical for either Van Buren or Upjohn. Although an attempt was made to reproduce the typical cavetto molding, the profile and the double architrave construction are unlike any other work; the door is hung on butt hinges with modern-type screws dated to c. 1850, is 4" to 6" narrower than other doors in the room, and includes recessed panels with no molding. It also has a carpenter-type lock, marked "J. Walker VR" dated to after 1837. The baseboard between doors 205 and 206 appears to lack early paint layers (P068). The chromochronologies of south and west baseboards are similar. Other minor changes in room 205 include

ca. 1840 removal of chair rails, evidenced by plaster infill (see rooms 105 and 109 for dating evidence)

ca. 1854 introduction of a hot-air register in the south end of the west wall (see section IV.C.2. for a comprehensive description of this heating system)

ca. 1950 steam-heat radiators in the southeast and northwest corners

ca. 1960 lowering of the ceiling; addition of quarter-round molding along the east and north (east end) walls at the base, electrical outlets, sanding, and varnishing of floor*

Note: All ca. 1950 and 1960 work was removed by the park maintenance staff in 1978.

With the exception of doors 205 and 206 and their casings, all woodwork in room 205 dates from the ca. 1797 construction. The double architraves of door and window casings include a cavetto molding used on all windows in rooms 201, 208, and 209 and used on the majority of doors in both original and reproduced work. Doors 203, 204, and hinged interior shutters are also typical for the 1797 work. The six-over-six window sash have been dated to the ca. 1840 remodeling by Martin Van Buren (see section IV.A.10.). Baseboards are plain with an ovolo molding at the upper edge.

The double architrave molding for door 206 is a close reproduction or variation in size and profile of the typical ca. 1797 work on the second floor. Door 205 is a less successful attempt at reproduction and is described above. The ca. 1797 casings for doors 203 and 204 appear to have been reused from previous locations.

*Other rooms that were sanded and varnished ca. 1960 include rooms 104, 106, 109, 111, 119, 201, and 210.

The wood mantelpiece in room 205 is slightly more elaborate than others found in the ca. 1797 house. It has a double architrave (compared with the single architraves used elsewhere) surrounding the typical second-floor, off-center opening. Also characteristic of the other 1797 mantelpieces are the plain frieze with curved outer ends, the overhanging cornice, and two recessed panels with integral molding to the east of the fireplace opening. The second elaboration of detailing is the extension of the mantelshelf across the entire width of the fireplace opening and the paneling. This differs from other ca. 1797 mantelshelves, which are positioned above the fireplace opening only. The firebox masonry and hearths do not appear to have been altered, except for repairs at the rear wall.

Paint analysis of woodwork confirms the physical evidence for all ca. 1797 elements. This full chromochronology includes a base layer of cream with green pigment particles followed by cream and whites.

Wallpaper was removed in 1978 by the park maintenance staff to reveal areas of beige paint, the chair rail infill, and a finish plaster white coat above the chair rail and a brown coat below the chair rail. A sample of the ca. 1841 wallpaper for this room (WP018) was found under the casing of door 206. It is a machine-made paper with a white ground and large brown, green, and yellow flowers and leaves. The earliest layer of fireboard paper is a scenic of undetermined design with a border matching the border of the fireboard in room 101 (also a bedroom during the Van Buren residency).

The wood floor is typical ca. 1797 work--4" to 5" tongue-and-groove boards laid in a north-south direction. The ca. 1960 sanding and varnishing revealed tack marks 36" on center. This evidence suggests a covering of 36"-wide grass matting.

The mechanical bell system included a bell crank on the west face of the chimney breast. The wire from the crank ran down into room 105, exposed on the west face of the chimney breast. It ran through the floor of the room, into the basement, where it appears to have run to room 005, the servants' dining room (see section IV.C.5.). High on the south wall is an opening similar to the one in room 201.

It is recommended that restoration of room 205 include the following work:

Make miscellaneous plaster repairs and stabilize, particularly at the south end ceiling along the east wall where the ca. 1960 lowered ceiling contacted the walls; fill the small south wall opening.

Repair (and replace) the nonhistoric masonry work at the rear wall of the firebox, and mortar fill between the stone lintel veneer and brick.

Reinstall the hot-air register.

Patch floorboard holes.

Reproduce the ca. 1840 floral wallpaper behind the casing of door 206 and hang with border on the fireboard; restore the fireboard scenic and border paper.

Restore the ceiling and cornice using a white calcimine.

Restore the woodwork to a cream color (Munsell 2.5Y 9/2, Benjamin Moore GB-30).

Remove the 20th century sash locks and replace with ca. 1840 reproductions; replace the window 207 stop; replace the HL hinges on windows 206 and 209.

Install a bell system wire and reproduction crank on the west face of the chimney breast.

d. Rooms 206/207/208/209 - Stair Hall/Game Room/Entry/Two Chambers

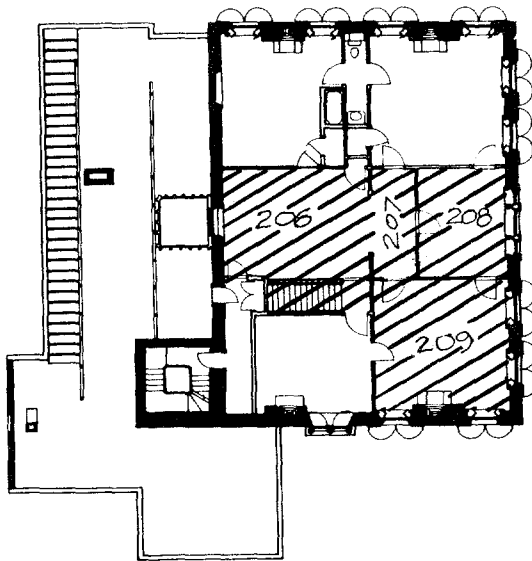

These four rooms are grouped together because of their inextricable relationship in the original and ca. 1849 plans for the second floor rooms of Lindenwald. In the ca. 1797 second-floor plan, room 206 was the upstairs hall, containing the U-shaped stairs. Rooms 207, 208, and 209 formed one large room, possibly a ballroom. (Ascribing the function of a ballroom to room 207/208/209 is only hypothetical. No documentary evidence indicating this use has been found.) By the time Van Buren purchased Lindenwald, the existing room divisions had been built. Room 206 continued to function as the central hall, with

room 110 as an open stair hall along its south wall (created by Van Buren ca. 1840); room 207 was a smaller hall; room 208 was a small (temporary) bedroom, whose secondary function was to provide access to rooms 205 and 209; and room 209 was a bedroom. In this plan, rooms 206, 207, and 208 shared a common decorative scheme. Their function was also similar, providing access to the second-floor bedrooms.

Documentary reference to rooms 206/207/208/209 in the 1841 wallpaper selection between Martin Van Buren and Harriet Butler assists in the designation of room names and functions. Room "No. 1" was identified by Van Buren in the May 15, 1841, letter to Harriet Butler as "the hall upstairs" and the chosen wallpaper included "the temporary Bed Room at the end of it," which is now identified as room 208 (Downs Collection). No other documentation has been found to clarify the duration of using room 208 as a bedroom or to elaborate upon the use of rooms 206 and 207 as hall space.

In the ca. 1797 plan, room 206 provided access to room 201 (D209), rooms 207/208/ 209 (D218), room 210 (D215A), and the attic stairs (D210). There was a window in the west wall (W213, see IP045). The room was dominated by the U-shaped stairs from the first floor at its west end. Physical evidence identifying the location of the ca. 1797 stairs is described under room 105.

Physical evidence on the second floor consists of a highly visible change in flooring, which produces a north-south centerline of butted floorboards. Temporary removal of a floorboard at the west end along the north wall attests to a change (or infill) of floor framing. An assumed plan shows the difference between the 1797 and ca. 1840 framing (see section IV.C.1. and appendix G, Evolution Sketches).

Much of the original woodwork remains in room 206. It includes doors and casings (D209, 210, and 215A; door 215A has been relocated) and the baseboard between doors 209 and 210 and along the east wall of the room. The double architrave used on the ca. 1797 door casings includes a cavetto molding that is typical for second-floor work of this period.

The plaster walls of room 206 were originally covered with decorative painting, applied directly to the plaster brown coat. Evidence of this wall painting is found on the north and east walls of the room. The paintings consist of horizontal bands of vinelike foliage and flowers painted in black, white, vermillion, and green. They are at the cornice and around the doors and chair rail (see appendix M). The woodwork was originally painted light yellow.

Primary access to rooms 207/208/209 was from room 206, through door 218 (see IP046). A single door (219) entered room 204 through the north wall of the room, and another door (216) provided access to room 210. None of these doors is in its original location. Door 218 has been replaced by the larger arched opening between rooms 206 and 207, and all evidence of the original door has been obliterated. The location of door 219 is marked by a ghost in the plaster wall of room 208 (see IP044). It is also marked by a continuous floorboard in the threshold area ending at the stud framing, which sits directly on a plate. This is the typical ca. 1797 threshold treatment. Door 216 was roughly 1'-3" to the south of its present location. Physical evidence of this fact includes a plaster ghost in the west wall of room 209 and evidence of the typical ca. 1797 threshold (see IP047).

Rooms 207/208/209 have a total of five windows. The dominant window is the Venetian window (see IP048). Its location is best described as in the center of the east wall of the present room 208. The Venetian window (east wall of room 208) consists of a round-headed central opening flanked by window openings of lesser height. The molding for the semicircular-topped casing is a single architrave with an ogee molding and bead. The smaller windows have outer jambs and lintels cased with the typical ca. 1797 second-floor double architrave with cavetto molding. Mullions and inner jambs are finished with recessed panels with an integral molding that matches work on ca. 1797 interior shutters. The upper sash of the Venetian window has eight lights

surmounted by a Gothic arrangement of muntins. The lower sash has six lights and the double-hung sash of flanking windows 203 and 205 match the sash used in windows 103 and 104, the sidelights to the front door. The muntin profiles of the lower sash and the sidelights match the other ca. 1840 replacement sash throughout the house.

Two other windows are in the east wall of the room (W201 and 202, see IP050). In the south wall two windows flank the mantelpiece (W217 and 218). The double architraves of the windows are composed of cavetto moldings. They have hinged interior shutters.

The typical ca. 1797 wood mantelpiece has a molded architrave surrounding an off-white opening, plain frieze with curved outer ends, overhanging cornice, and two recessed panels with integral molding to the east of the fireplace opening. The mantelpiece in room 209 may be distinguished from other mantelpieces by the return of the crown molding of the cornice along the east and west portions of the paneling, encompassing the full width of the chimney breast. This does not include the mantelshelf as in room 205. The firebox masonry and hearth do not appear to have been altered, except for repairs at the rear wall.

The ca. 1797 baseboards are unlike any others found in the original house. They consist of a cyma recta molding with a bead along the upper edge.

The plaster walls of rooms 207/208/209 were decoratively painted. The painting was applied to a basecoat of green paint (761). This was the only room where the walls were painted with a ground color before application of the decorative paint schemes. The pattern of the painting consisted of floral festoons separated by vertical tassels. The colors used were black, white, and vermillion. The decorative painting was applied only below the cornice. Evidence of this wall decoration can be found on all the original walls in this room (see appendix M).

The earliest layer of paint or woodwork was a pale yellow color, with the typical subsequent layers of creams and whites.

A faint elliptical outline in the plaster ceiling in the center of this room suggests that a plaster molding and possibly a chandelier hung in this location.

Evidence that most strongly supports configuration of this room includes

the decorative wall painting on the east, south, and west walls of room 209, on the west and north walls of room 207, and on the north and east walls of room 208; this decorative painting is not found on the walls separating these rooms

a portion of the plaster wall, with green paint and decorative painting, that extends behind the wall separating rooms 207 and 209

the matching of all baseboards in these rooms, which are unlike any others found in the ca. 1797 house

the markings in the plaster ceiling, along the north wall of room 209, that are probably from a plaster molding that would have been in the center of the large room

the same original paint layer on the woodwork in rooms 207/208/209.

The alterations made to the second floor that transformed the plan of these rooms probably occurred ca. 1810, when William Van Ness inherited the property from his father, Peter Van Ness. This date is supported by paint analysis, the presence of chair rails along the new partition walls, and the types of nails used to make the alterations.

With the exception of the building of the arched opening between room 206 and 207, room 206 escaped significant physical alteration ca. 1810. Physical evidence suggesting that the present arch dates to ca. 1810 includes plaster irregularities surrounding the arch on all sides, a difference in molding profiles and pilaster detailing from the ca. 1797 arch in room 106, the absence of the early paint layers found elsewhere in this space (see P176, 178), and most conclusively the absence of ca. 1797 hand-wrought nails. No physical or documentary evidence has been uncovered to suggest what the original ca. 1797 design might have been. X-rays 004-007, taken through the pilasters, show cut nails with early machine-made heads having a taper at the upper end of the shank. This nail type is earlier than Van Buren's ca. 1840 work and is not consistent with the modern-type cut nails with standard machine-made heads associated with ca. 1849 work (see section VI.D.4.a., artifact samples A054, 067).

The arch between rooms 206 and 207 is an "anse de panier," meaning an arch whose curve resembles that of the handle of a basket (see IP046).^{*} It may also be called a three-center arch. Many of the elements that make up the arch and pilasters resemble elements of the ca. 1797 arch found in room 106. Execution, however, is not the same, and combined with other physical evidence discussed above, the similarities must be regarded as partial attempts at reproduction.

The moldings used to form the arch match the overall profiles and composition of the ogee arch in room 106, except that the second-floor arch is much larger. This "basket" arch also has a keystone. Detailing of the three-sided pilasters is quite different from the work in room 106: The north and south jambs of the two pilasters are recessed into three panels with applied moldings, the east and west sides have circular and elliptical tracery. The entablatures are somewhat similar to doors 134 and 135. There is a simple and small architrave, and a frieze with single flutes alternating with three-part reeding (the center portion being shorter). The reeding comes in contact with the fillet and astragal of the cornice. A cavetto molding, astragal, and convex detail course is surmounted by a course of three flutes alternating with incised circles in the corona location.

^{*}The Penguin Dictionary of Architecture by Fleming, Honour, and Pevsner, p. 15, states, "It is formed by a segment of a large circle continued left and right by two segments of much smaller circles."

In rooms 207/208/209 the alterations were much more extensive. The walls that created the present room plan were erected, transforming the one large room into three smaller rooms. Evidence supporting this date includes the gray-green paint on the plaster walls (P762, 763). This paint is different from the green paint found on the original walls of the room. It is not found in the area of the chair rail, indicating that it was applied to the walls before 1840.

Door 219, which was originally centered in the north wall of rooms 207/208/209, was moved approximately 5' to the west, and a second door, possibly reused from door 218, (see P771-174) was installed approximately 5' to the east of the original location of door 219. Lath nails found in the infill of door 219 can be dated to ca. 1810.* Other evidence supporting this date includes chair rail infill and the gray-green paint layering in the door infill area.

The moving of door 219 and the adding of another door to this wall meant that access could be gained to room 204 from room 207, as well as room 208. This would have been important, especially if room 208 was to be used as a bedroom as has been indicated.

Doors 217 and 201 in rooms 207 and 208, respectively, also represent ca. 1810 work. Their placement is opposite the doors in the north walls of rooms 207 and 208. They served a similar function to the ones on the north walls. Their casings match one another and represent a slight profile variation from the typical ca. 1797 cavetto molding used on the second floor.

Door 202, between rooms 207 and 208, has a fanlight above its casing (see IP049). It is the only door at Lindenwald with such a window. It was placed there to provide the windowless room 207 with natural light. The casing of this door also varies slightly from the typical ca. 1797 moldings. As with the casings of doors 201 and 207, these variations include depth and angle of the cavetto profile, size of wood used for the cavetto molding, size of the bead used on the cavetto molding, and profile difference of the molding between architraves.

Doors 201, 202, and 217 are apparently the result of an attempt to match the ca. 1797 doors; however, they differ from the original doors in that they are hung with cast-iron butt hinges, rather than HL hinges (see IP050).

Doors 201 and 217 have rim locks marked "Green & Broad/New York," which have been dated 1837 to 1845. Door 202 has a cast-iron beveled rim lock attached with later machine-made screws. The date of this installation has not been determined; however, there is also evidence on door 202 of a previous lock/paint outline and Dutchman for keyhole and knob shaft locations, which matches the configuration of the "Green & Broad" locks.

Other minor ca. 1810 alterations in rooms 207/208/209 included installing reproduction baseboards, chair rails, and plaster

*These lath nails are a modern-type cut nail with a handmade head.

cornices along the new partition walls and removing the plaster ceiling medallion in the center of the room. An astragal molding with cut corners outlining the perimeter of the room was added. The floorboards in rooms 207 and 208 also appear to have been replaced at this time.

Ca. 1810 plaster walls in rooms 206 and 207 were painted blue, the same color as the walls in room 105. The woodwork was painted a cream color (see P486). The use of the same paint color in rooms 206 and 207 suggests their similar use as access halls. Rooms 208 and 209 were painted green (P760, 762). The woodwork in these rooms was painted cream.

Ca. 1840, Van Buren removed the stairs from room 206 and relocated them at the south side of this room in an area previously occupied by room 210. Physical evidence of this move consists of a highly visible change in flooring which produces a north-south line of butted floorboards. Temporary removal of a floorboard at the west end along the north wall attests to a change (or infill) of floor framing. An assumed plan shows the difference between the ca. 1797 and ca. 1840 framings (see section IV.C.1.).

Paint samples from baseboards in room 206 also confirm that baseboards were installed on the north, west, and south walls at the time of the stair relocation (see P159, 161-163). Other changes connected with the stair removal concern its relocation into space previously occupied by room 210, to the south of room 206. Ca. 1840 work created a larger room by the relocation of the south wall of room 206 farther to the south. The ghost of the original location of the east end of the south wall is apparent in the east wall. This partition ghost is in line with a change in floorboard direction where door 215 was located in 1797.

Details of the ca. 1840 stairs are not apparent because of the subsequent redesign by Upjohn ca. 1849.

Van Buren also removed all the chair rails from rooms 206, 207, 208, and 209 and redecorated the rooms. For rooms 206, 207, and 208 Van Buren appears to have chosen a single decorative scheme. The typical cream color of woodwork was used together with a wallpaper described by Harriet Butler as "an old favorite of mine" (letter of May 17, 1841, to Martin Van Buren, Downs Collection) and by Van Buren as "neat but not expensive. Something like that we first selected for the lower Hall" (letter of May 15, 1841, to Harriet Butler, Van Buren Papers, CCHS). Appropriate wallpaper fragments in room 206 were found as the base paper layer on the north and west walls above the pre-Van Buren painted blue wall finish that continued as part of the then central stair hall of room 105 (WP015). Confirmation that this same paper, a yellow geometric pattern on a white background with aqua stripes, was used throughout rooms 206, 207, and 208 came from a matching fragment discovered behind a nonhistoric iron pintle to the south of window 203 (the Venetian window in room 208).

Fragments of wallpaper were found in room 209 under the window aprons and in the area covered by plaster between windows 217 and 218. Testing for a fiber type indicated that the fragments found

between the windows are a wood-pulp wallpaper and therefore date after the historic period. The fragments found under the window aprons are made of rag fibers and therefore could date to Van Buren; however, they are too small to serve as the basis for a reproduction wallpaper.

The fireboard in room 209, also purchased by Van Buren, has raised questions that have yet to be resolved (see IP047). The fireboard that was identified with this room is covered with the green geometric wallpaper (002) used to line the scenic wallpaper in room 105 and to line papers in areas of chair rail plaster infill. The border is a black-and-green key design. This fireboard is the largest of all extant fireboards and would not be accommodated in any other fireplace opening. Most fireboards fit the area within the wood mantelpiece opening, in front of the stone surround. The width of the fireboard selected for room 209 appears to have overlapped the wood mantelpiece by 8-1/2".

A different fireboard has been identified through study of a photograph from the 1936 Weig report. This photograph shows a scenic wallpaper on the fireboard with a border matching the border used in room 104. The wallpaper on the wall is 20th century paper. The fireboard itself has not survived. Questions remain about the correct fireboard and the proper location of the existing fireboard and Van Buren period wallpaper.

Ca. 1849 Richard Upjohn completely redesigned the stairs in room 110 (see IP051). The existing stairtreads, risers, handrail, turned balusters, and all related parts have been dated to Upjohn on the basis of paint analysis (see P226 and 239). Other changes in this area included appropriation of additional space from room 210 to accommodate a passage, room 211, from the southwest corner of room 206 into the tower stairhall.

The other major alteration made in room 206 by Upjohn was the remodeling of window 213. The molded plaster trim of this window, with a semicircular opening, is typically Upjohn in its large and simple scale, although no match of its moldings has been found. The inner edge of the molding is chamfered with a lamb's tongue at the base. The chromochronology does lack the early layers of ca. 1797 elements (see P173, 175, 479, and 481). The lower portion of this opening has a solid backing of four flush-and-beaded vertical panels with five full and two half balusters in front, capped by a peaked rail.

No work in rooms 207, 208, or 209 has been attributed to Upjohn.

Evidences of both the ca. 1854 hot-air heating system and the ca. 1840 mechanical bell system have been found in rooms 206, 207, 208, and 209. Evidence of the heating system is found in room 206, where ductwork was installed in the closet entered through door 210 and a register built into the door. The introduction of the ductwork in this closet reduced its size. The shelves in this closet appear to have been installed at this time.

Openings in the north walls of rooms 206 and 208 may have contained registers that allowed heat to pass from rooms 201 and 205 into their respective adjoining rooms (see IP043 and IP044). An alternative hypothesis suggests that these holes allowed stovepipes to pass from stoves in rooms 206 and 208 to flues in rooms 201 and 205 before the installation of the furnace.

A crank for the mechanical bell system was on the east casing of door 209 in room 206. Physical evidence indicates that the wire from this crank ran into room 207, exposed at ceiling height, and up into room 304, a servants' bedroom, where a bell is still located. This is the only crank found thus far that is connected to a third-floor room. In room 209 a bell crank was on the west side of the fireplace with connection to room 005, the servants' dining room. No evidence of the bell system has been found in room 208.

It is recommended that restoration of rooms 206, 207, and 208 include the following work:

Stabilize and reconstruct the ceiling plaster on original lath where feasible. (About 60 percent of the ceiling at the west end of room 206 has fallen or is patched, and plaster keys are missing in this room and in room 208; also part of the southeast corner ceiling area may be a gypsum board; this deterioration appears to have been caused by roof and gutter failures.)

Make miscellaneous plaster wall repairs (holes in north walls of rooms 206 and 208) and prepare the surface for wallpaper (subject to further research by NAHPC).

Make miscellaneous woodwork repairs, including replacement of 1-1/2 balusters on the stairs, replacement of 14 dentils in the entablature of the arch pilasters, and removal of floor paint.

Reproduce the yellow wallpaper with a geometric pattern (015) and hang with a border like the one in room 210.

Restore all ceiling and cornice areas using calcimine.

Restore all woodwork to a cream color (Munsell 5Y 9/2, Benjamin Moore GB-60).

Restore the finish on the floors (to be determined).

Install a bell system wire and reproduction crank on the east casing of door 209 in room 206.

The preservation and restoration work recommended for room 209 includes the following items:

Make miscellaneous plaster ceiling and wall repairs.

Remove nonhistoric masonry repairs at the rear wall of the fireplace and replace with matching brick and mortar color and texture.

Fill with mortar between the brownstone lintel veneer and the brick masonry.

Repair shutters including possible replacement of the south inner jamb board of window 202, replacement of window stops at windows 202, 217, and 218; remove nonhistoric sash locks and replace with ca. 1840 reproductions.

Fill the floor holes in previous radiator locations.

Restore the ceiling and cornice using calcimine.

Restore all woodwork to a cream color (Munsell 2.5Y 9/2, Benjamin Moore GB-60).

Reproduce and hang the wallpaper and border found on the fireboard.

Install a bell system wire and reproduction crank on the west side of the chimney breast.

e. Room 210 - Chamber

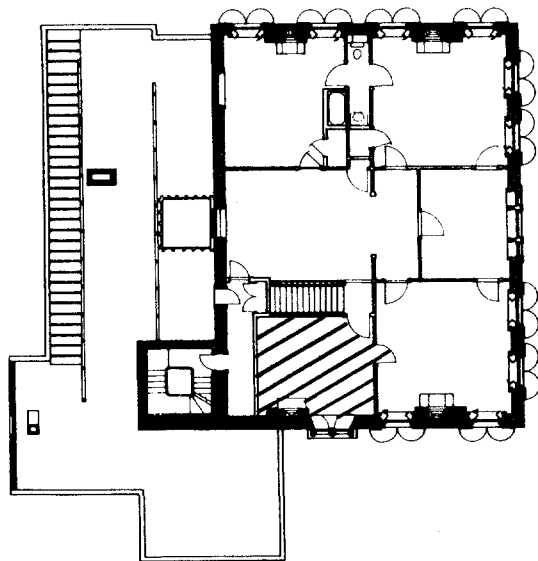

This second-floor bedroom is in the southwest corner of the ca. 1797 house. Access is from a door opening in the north wall from the central hall (D215, see IP052). There is a door opening (D216) in the east wall leading into room 209, the southeast bedroom. The bay window in the south wall has two round-headed windows (W215, 216, see IP053). A chimney breast is also located in the south wall.

A letter from Smith Thompson Van Buren to Upjohn on November 22, 1849, documents this room as the bedroom of Martin Van Buren, Jr.: "The window . . . which you directed to be made longer to light the passage next to my brother's bed-room" (Upjohn Papers). This passage, room 211, was added by Upjohn to provide access between the tower and room 206. It runs along the west wall of room 210.

The fireboards provide little additional information about the room. The paper appears to be appropriate and consistent with correspondence. Martin Van Buren had specified paper that was "neat but cheap" for "Martin's Bed Room" (letter to Harriet Butler, May 15, 1841, Van Buren Papers, CCHS). Mrs. Butler, in choosing the wallpaper, stated, "There is certainly nothing exciting in the colors and to an invalid it will be rather quieting to the nerves" (letter to Martin Van Buren, May 17, 1841, Downs Collection).

The many changes that have taken place in this room date from the first quarter of the 19th century, during William Van Ness' residency, to the 1960s work of Campbell. The indicators for one of the earliest changes (the door location on the east wall) include

a vertical plaster crack and unevenness in the plaster surface to the south of D216

two types of split lath, butting irregularly--exposed by the Campbell wiring work

the remainder of the plate exposed at the north side upon removal of the nonhistoric threshold

the extension of typical threshold floorboard under the wall and butting of the plate to the south of the existing door casing--exposed during baseboard removal by Campbell

the comparative framing widths of door 203 and the original room 205 south wall door opening, which are the same 41-1/2" as the original door 216; the existing door opening is 7" narrower

the chair rail infill, ca. 1841, immediately south of the door casing, within the plaster infill area

Based upon the split lath used for the plaster infill and the chair rail infill, this door relocation may be dated as pre-Van Buren and probably to the time of William Van Ness.* Possible association of this change with the introduction of the partitions between rooms 207, 208, and 209 has been made through a comparison of lath nails. Lath nails with crude machine-made heads were retrieved from the infill area south of door 216 and appear to be similar to nails revealed by X-ray through the wall dividing rooms 207 and 208 (see X-rays 010-012.)

A second change occurred ca. 1840 during the relocation of the original central hall stairs. As with the room below, room 210 suffered a loss of approximately 6' when its north wall was moved farther to the south. Beyond the case established for the relocation of the stairs (see room 105), which necessitated an alteration to room 210, physical evidence can be seen in the continuous floorboards that run from the ca. 1840 stair landing into the bedroom, the original wall location where the floorboards of the central hall (room 206) are perpendicular to the floorboards of the original bedroom, the remains of the wall plate, and a vertical patch in the plaster of the east wall (see IP042). The original door casing was reused in a north wall opening (slightly to the east of the original location). Paint evidence suggests that the baseboard on this wall was also reused (P369). The plaster cornice was duplicated on the north wall. The absence of plaster infill in

*A letter from Martin Van Buren to Gorham A. Worth, dated April 9, 1849, states that "William P. [Van Ness] came and disfigured every thing his father had done." Documentary and/or physical evidence of work during the subsequent Paulding ownership has not yet been found. Van Buren Papers, LOC.

the chair rail area of the relocated north wall indicates that Martin Van Buren did not include chair rails in the finish treatment of rooms, and thus it provides additional evidence for the removal of chair rails as part of the ca. 1840 alterations.

The dismantled condition of the south wall fireplace exposes infill masonry at the splayed jambs. The infill appears to have increased the angle of the jamb, decreased the firebox depth, and retained the same height. The jamb infill is feathered with brick fragments and mortar to maintain the original width and meet the original facing of brick. Vertical slabs of brownstone, approximately 6" wide by 31" high, were used to cover the feathered portion of masonry. The jamb infill bonds with that of the back, suggesting that it is also an infill.

The firebox bricks are laid flat and parallel to the hearth, comprised of three black stone slabs. Oral history from Kenneth Campbell and physical evidence indicate that the dismantling of this fireplace was the result of his attempt ca. 1960 to convert room 210 into a kitchen. The mantelpiece is still intact although not secured against the masonry. The five slabs of brownstone facing are missing.

Nine years after Van Buren's changes came another wall relocation. In 1849, according to the design of Upjohn, the west wall was relocated more than 4' eastward. This created a passageway, room 211, to permit access from the second-floor central hall, room 206, to the tower stair hall (see IP054). Room 210 lost one west wall window and possibly a window at the west end of the south wall. The wood lintel and brick infill masonry for the west wall window can be seen in the Upjohn passage, room 211, and room 307. The plaster cornice along the west wall was duplicated to match the ca. 1797 cornice. The wood baseboard does not match the ovolo upper edge molding of the ca. 1797 baseboard; it is simply a beveled edge.

An additional 1849 change includes the removal of the ca. 1797 window opening at the east end of the south wall and its replacement with a bay window containing two round-headed windows (see IP053). Removal of the vertical-board wainscot, probably during ca. 1960 renovations (specifically, pipe routing), has left the brick masonry exposed. Painted brick in this area were reused from the exterior brick, either those removed for the larger window opening or those salvaged from other demolition.

The next period of significant change took place nearly one hundred years later, in the series of 1940s modifications by the DeProse family. Based on the color photographs of DeProse family members in park files, the dating of existing wallpapers, the 1936 Weig report describing original wallpapers in the house, and the oral history indicating that the DeProse family painted other rooms (such as room 119), the stripping of wallpapers in room 210 and the subsequent painting of blue calcimine can be dated to the DeProse residency. The painting predates the installation of what may have been kitchen base cabinets installed by Campbell along the south end of the east wall. A wallpaper fragment of a ca. 1960 kitchen design is in place at the upper north

corner of the east wall. Installation of a kerosene heater, evidenced by an infilled circular opening in the chimney breast, probably dates to the DeProsse family.

Physical evidence of Campbell's ca. 1960 conversion of room 210 into a kitchen included

holes in the floor for water and drainage pipes and cutting of southeast corner floorboards

removal of southeast corner baseboards

installation of base cabinets along the east wall

installation of a kerosene heater

plywood paneling as wainscot along the north and west walls

electric wiring, including channeling of wall plaster for wires and installation of outlets

sanding and varnishing of floors

Except for electrical wiring and outlets, all of the above intrusions were removed by the park maintenance staff in 1977.

There are two periods of woodwork represented in room 210. The ca. 1797 elements include the two door casings, baseboards along the east and north walls, and the mantelpiece. The typical ca. 1797 mantelpiece has a molded architrave surrounding an off-center opening, plain frieze with curved outer ends, a projecting cornice, and two recessed vertical panels with integral molding to the west of the fireplace opening.

The ca. 1849 woodwork includes a west wall beveled baseboard and the south wall bay window. The casing of windows 215/216 is typical Upjohn design for rooms within the ca. 1797 house, primarily composed of earlier elements. The molding is also found on door 128 in room 109 and on window 212 in room 201. The west casing includes only a portion of the first architrave because of its proximity to the chimney breast. The sash is four-over-four, double-hung, with a semicircular upper sash. Jambs are splayed to receive one-leaf hinged shutters with eight recessed panels with applied molding. The vertical board wainscot appears to have had square-edged vertical battens and a beaded baseboard.

Door 216 has undergone a series of alterations through the years. The presence of finished flooring and a cut-off wall plate in the present door opening indicates that there was a ca. 1797 opening approximately 1' 5" south of the present opening. The elements of the present opening have been dated to different periods on the basis of internal evidence, but these dates differ significantly and resolution of the conflicts has not been possible. The molding study dates the casing of door 216 to 1804-1824. The cut nails used to attached the casing have

common burrs and irregular point--features which date to ca. 1840. Lath nails in the patch to the south of door 216 and the presence of a plaster patch at chair rail locations indicate that the door was moved prior to Van Buren's occupancy, probably ca. 1815. The hinges, screws, and lock used on door 216 all date to ca. 1840. This evidence, combined with the evidence of ca. 1840 nails in the casing suggests that Van Buren made extensive alterations to the door opening that had earlier been moved.

Door 215 and its casing and the mantelpiece have base layers of blue paint. The color is also found on the upper molded edge of the baseboards; the flat portion was painted red. Remaining woodwork of the 1849 period and the east wall door and casing have layers of creams and whites only.

Varnished tongue-and-groove floorboards of 4" to 7" widths run in a north-south direction. Tack marks for grass matting are visible in an east-west direction, approximately 36" apart.

The preservation and restoration work recommended for room 210 includes the following items:

Stabilize the plaster, make miscellaneous repairs, and infill.

Replace the wood baseboards and window wainscoting with battens.

Replace the fireplace brownstone facing material.

Remove the electrical wiring and outlets.

Reproduce the wallpaper (019) found behind the door 216 casing and on the fireboard; hang with reproduced border paper as found on the fireboard.

Restore the woodwork to a cream color (Munsell 2.5Y 9/4, Benjamin Moore GB-60).

Restore the plaster ceiling and cornice to a finish whitewash.

Remove floor varnish.

Clean the shutter pulls and replace the center mullion hardware for securing shutters in a closed position.

f. Room 211 - Hall

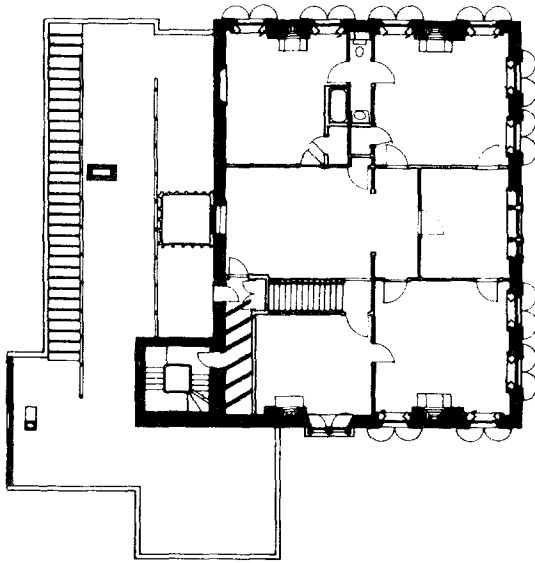

Room 211 occupies a narrow rectangular space in the extreme southwest corner of the 1797 house (see IP054). This passage from room 206 to the tower stair hall and to the Upjohn attic was separated from room 210 in 1849. The door from room 206 (D211) is in the north. Doors into room 213, the Upjohn attic (D212), and room 212, the tower stair hall (D214), are in the west wall. There is a closet in the north end of the east wall, and the lower portion of window 315 is in the south wall.

The ca. 1797 to 1849 use of this space was as part of the bedroom, room 210. The location of the west wall window was approximately 5' 4" from the south plaster wall. Infill masonry is currently exposed south of door 214, the probable location of a window in the ca. 1797 house.

Relocation of the main stair hall by Van Buren ca. 1840 made an L-shaped room out of room 210. The removal of the chair rail as part of the same period of work may be seen along the west wall of what is now room 211.

Chair rail infill does not exist along the east wall of room 211 because this wall was added in 1849 to form the present passageway. The addition of door 211 on the north wall has obliterated the evidence of the ca. 1840 removal of chair rails.

A change in room 211 that was made around 1850 is documented in a letter from Smith Thompson Van Buren to Upjohn, dated November 22, 1849. This letter describes "the window . . . which you directed to be made longer to light the passage next to my brother's Bed Room" (Upjohn Papers). This window is a lancet window originating in room 307. An extension of the lower portion was apparently made so that 5-1/4" of window height enters into room 211.

Other changes to room 211 have been the result of roof deterioration. The addition of the tower in 1849 next to the west slope of the 1797 gable roof did not include a provision for shedding water at this junction. Damage in room 211 has been to the plaster wall and ceiling in the southwest end, causing 60-70 percent of the entire ceiling to fall.

Woodwork in this passageway dates to ca. 1849 and is a typical design for Upjohn secondary spaces. Doors 211, 212, and 214 are four-panel doors with the typical Upjohn molding on one side. The more decorative sides face rooms 206 (D211), 212 (D214), and 211 (D212).

The inner jamb panels at door 214 are also typical Upjohn recessed panels with molding. Atypical features include the lack of a molded outer edge on the casing of door 214 and the obscuring of lintel moldings on doors 214 and 212 by ceiling plaster. Baseboards are typical Upjohn work.

Other woodwork of an unknown date is in the northeast closet area. The double doors of door 213 have a flat casing without molded edges and doors without molding that appear to have been handplaned. The closet area has four shelves: three are 5/8" and one is 1" thick. There are two board-widths for each shelf, all of which are supported by ledgers secured with cut nails. The ledgers and shelves are supported by vertical end boards resting on and obscuring the molded edges of the Upjohn baseboards. None of this work is painted. The shelving work is similar to the closet behind door 210. A vertical patch in the plaster of the west wall of room 307 is in line with the north wall of room 210. This indicates that between ca. 1840 and 1849, room 210 was rectangular and the closet and north end of the present room 211 were probably a closet area. Nail holes in the flooring at either side of room 211 and in line with the north wall of room 210 might be evidence of the studs at either side of a doorway that provided access from room 210 to this closet area. The Upjohn baseboards appear to be carelessly installed replacements since the finish plaster stops above them, revealing an area of scratch coat plaster that was concealed behind the original baseboards. The plaster of the east wall (assumed ca. 1840) is butted against the plaster of the north wall (assumed ca. 1797). Plaster is continuous between east wall and south wall of this closet. Although there are no other shelved closets built by Upjohn for comparison, this work is not convincing and will require further investigation, if possible, to conclude whether it will remain as part of the Van Buren period restoration.

Plaster walls and the remaining ceiling are unpainted and should remain so. All woodwork is the typical Upjohn color of tan. The floor was originally unpainted.

The preservation and restoration work recommended includes the following items:

Stabilize and reconstruct the plaster on the original sawn lath and masonry walls.

Clean the plaster walls and ceiling.

Restore all woodwork to a tan color (Munsell 10YR 8/2, Benjamin Moore GB-60).

g. Room 212 - Tower Stair

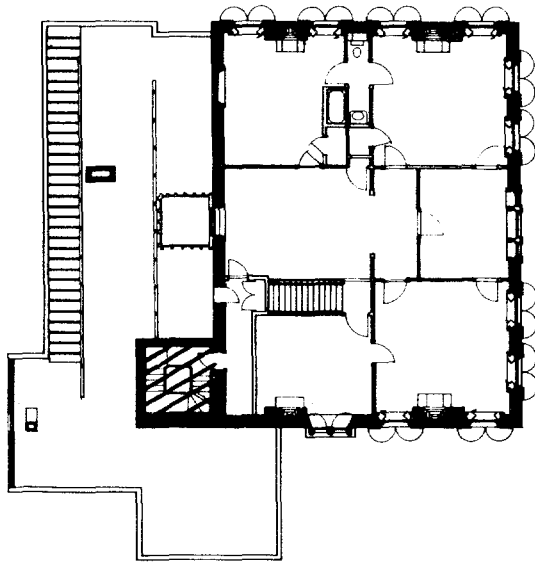

This room is the second floor level of the 1849 tower. The first floor of this stairhall is described as room 113.

The stair begins at the north end of the west wall in room 113 and makes continuous quarter-turns in a series of five risers with landings and winders up to the level of room 308. The entire construction is a cantilevered support system with various sizes and configurations of wood joists pocketed into the exterior brick walls (this construction is partially exposed in the third-floor area where plaster has been removed; see IP068). There are individual arched

windows, two in each elevation (except the east), above the room 212 level. Access to room 212 is from rooms 113, 211, and 308.

Minor 20th century changes include closing off the stairhall at room 212 with a partition and localized deterioration of the plaster "ceiling" areas under the stairs.

The interior finish of this stairhall includes typical Upjohn details. The baseboards are the more decorative design used in primary rooms, such as rooms 111, 117, and 119. The entire length of the interior stringer is also finished with a moulded cavetto edge. The turned balusters and handrail are in their original, natural wood finish (probably of walnut; see IP055).

All woodwork, except the balusters and handrail, was painted tan. Although treads and risers of the stairs were painted light brown, subsequent paint layers have covered this original layer on the first and second levels. It does appear as the surface layer on the upper levels. Plaster walls and ceilings are unpainted.

It is recommended that restoration include the following items of work:

Stabilize the plaster.

Clean the plaster walls and ceiling.

Restore all woodwork except stair balusters, handrail, treads, and risers to a tan color (Munsell 10YR 8/2, Benjamin Moore GB-46).

Restore the treads and risers to a light brown color (Munsell 10YR 6/2, Benjamin Moore ET-45).

h. Room 213 - 1850 Attic

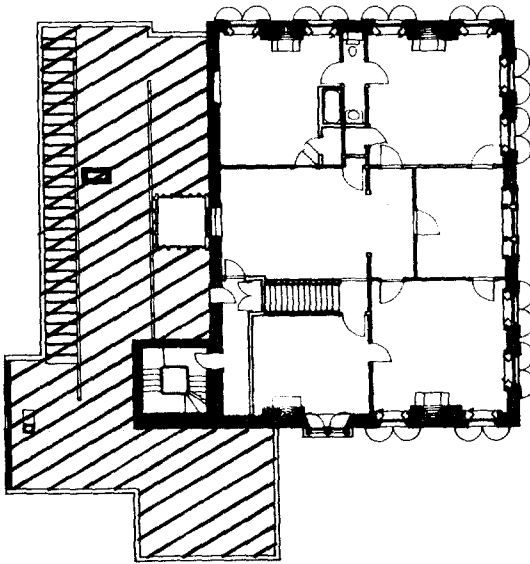

Room 213 is the entire attic space above the one-story addition except the tower stair and skylight. This space extends along the entire west wall of the 1797 house, wraps around the tower at the south end, and extends around a small portion of the south wall of the 1797 house. Access to room 213 is from room 211 through door 212, and up one 12-3/4" step.

All areas are unfinished open rafters, two parallel roof trusses, and steel jack posts at the north end. All areas have wood flooring except immediately west of the west truss where the floor joists are exposed and filled with

fiberglass batt insulation. The support structure for the monitor skylight is located in room 213 along the west wall of the 1797 house (see IP056). Visible construction consists of wood studs and sawn lath. A round window (214) with four-light sash held in place by turnbuttons is located in the west gable end (see IP057).

A chimney above room 118 that contains the flues for fireplaces in rooms 118 and 011 (see IP070) and a chimney above room 112 (see IP057) pass through this space. The chimney above room 112 does not appear in historic photographs 5 and 6, which are dated ca. 1890-1900. Physical evidence of plaster, wallpaper, and paint layers in room 112 confirm its recent date. Therefore, the chimney should be removed, the roof should be repaired, and the ceiling of room 112 should be patched. Since room 213 will not be open to the public, the part of the chimney there could be preserved as evidence of changes made to Lindenwald after Van Buren's death and in the course of restoration work.

A piece of brownstone, 1'6" by 2'3" by 5" embedded in the southwest corner of the tower masonry matches two splashblocks that were found at the southeast and northeast corners of the house (see IP058).

Changes to room 213 include

a reworking of the chimney flues that are routed through the south tower wall, apparent in the masonry

a 10-1/4" diameter hole in the floorboards above room 112 and in line with openings in the floor and ceiling of the same room

1978 restoration contract work, consisting of the replacement of sheathing and rafters and relaying of several brick courses at the

south wall of the tower. (All new work is visibly apparent and generally occurs in areas of flashing failures, such as the skylight and tower perimeters.)

The entire space is unpainted except for the door 212 casing (tan) and the original exterior wall of the ca. 1797 house. The exposed surface paint color is cream. The brick infill of window 212, dated c. 1849, is not painted.

The preservation and restoration work recommended for room 213 includes the following items:

Clean and remove all extraneous materials.

In the future, remove the west chimney.

Reconstruct the plaster on all walls of the monitor skylight as described under room 119.

Replace the door 212 knob.

Cover exposed joists with plywood; install polyethylene sheet vapor barrier and R-30 fiberglass butt insulation.

Third Floor

a. General

Because the third floor was one large room with east and west knee spaces prior to 1849, the evidence for that configuration will be presented first and then the present rooms will be described individually.

The ca. 1797 structure of the third floor consists of 6" by 9" floor joists spanning east to west at approximately 4'3" centers. They are supported at the ends by the brick exterior walls and at the center by a second-floor partition. Rafters are 6" by 8", mortised into the floor joists at the exterior walls and into posts at the ridge. Vertical braces are located between the joists and rafters approximately 10' from the east and west walls. There are diagonal braces between the central posts and the rafters on both sides.

There is plaster on the north and south brick gable end walls between the vertical braces and all the way up to the underside of the rafters at the ridge. On the inner faces of the vertical braces are T-head wrought nails and nail holes that indicate that the side walls of this space were probably finished with horizontal boards (see IP059). It has not been possible to determine if the ceiling had a finish other than exposed rafters and sheathing because the rafters are now covered with historic lath and plaster.

Between c. 1797 and c. 1849 there were two windows in each gable end--304 and 306 in the north wall and 316 and 317 in the south wall. These were all bricked in during the ca. 1849 alterations.

Floorboards between the vertical braces are face-nailed (rosehead nails) tongue-and-groove boards, 1-1/4" thick of

random widths from 9-3/4" to 11-1/2". In the few areas where there is flooring outside the lines of knee braces (the present room 301 and the gable and dormer areas associated with ca. 1850 work), floorboards are 6" to 9-3/4" wide and face-nailed with cut nails. In the floor of the present room 302, near door 305, is an area of patched flooring 2'8" by 4'3" that relates to the ghost of a stair on the east wall of room 203 below (see IP060). Present access to the attic is from the ca. 1850 tower stair. Thus, the stair from room 203 could not have been closed prior to the ca. 1850 building campaign as there is no evidence of any other means of access prior to ca. 1850. Furthermore, it can be shown that the stair opening was patched in the course of the ca. 1850 building campaign because one edge of it is covered by the baseboard of the east wall of room 302 and by the threshold of door 305. This evidence, when viewed as a whole, suggests that the ca. 1797 to ca. 1849 configuration of the third floor was a single rectangular room with 4'6" knee walls, consisting of boards nailed to the knee braces of the roof structure and exposed rafters, king posts, braces, and sheathing. Light was provided by two windows in each gable end and access was by a steep stair from room 206 through door 210. The third floor will, in general, be treated as an architectural preserve. With the exception of insulating the floor, the only work recommended for this area is that required for its preservation - primarily patching of plaster.

b. Room 301 - Attic

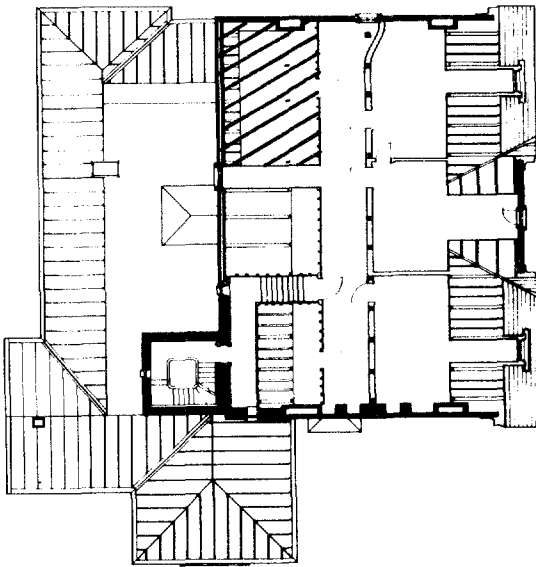

Room 301 is in the northwest corner of the third floor (attic) of the 1797 portion of the house (see IP059). It is a rectangular space approximately 14' by 21'. Since it has no windows and the walls and ceiling are not finished, it is assumed to have been used for storage only.

The east and south walls are constructed of wood studs, most of which are reused lengths of architrave and cornice moldings. There is no finish on the room 301 side of these studs, but the back side of the circular-sawn wood lath and plaster that forms the finish of room 302 is exposed between the studs.

The architrave moldings (with one exception) match the ca. 1797 moldings found elsewhere in the house, but the cornice molding is unique. Both a 2" by 6-1/4" crown molding and a 4" by 1-1/8" soffit board are in this room. The crown molding has a parabolic ovolo profile flanked by fillets. The soffit board has a 1" by 1/4" rabbet cut in its upper/outer edge and unpainted 3-3/4" by 4" rectangles at 8" centers (apparent dentils) on its underside. Both pieces are painted with one finish layer of paint which matches the yellow/cream color found on the ca. 1840 exterior. Two original nails (considered original because their heads had this paint layer) were the ca. 1840 type of common nail with diagonal burrs and sheared points (see section VI.D.4.a.). Thus, these pieces are possible

survivors from the wings or the main house cornice or some unknown structure demolished ca. 1849.

The north wall is the brick exterior wall of the gable end of the ca. 1797 house. A brick chimney projects from this wall. West of the vertical line where the line of vertical braces intersects the north wall, there is no evidence of plaster or any other wall finish. East of that line are the deteriorated and water-stained remains of a three-coat plaster. Room 301 has no west wall, because the roof structure slopes continuously downward to meet the floor joists and brick bearing wall.

The floorboards are all face-nailed tongue-and-groove boards. Those east of the knee braces are 9-3/4" to 10-3/4" wide, others are 7-1/2" to 9-3/4" wide. A 2'-wide strip at the west side of the room has no floorboards. The exposed floor joists are handhewn, measuring 6" by 9" and spaced at approximately 4', with two sash-sawn 3" by 8" intermediate joists in each space.

The ceiling of this room is the exposed underside of the roof structure, sloping down from a height of 6' 8" at the east wall to the floor level on the west. Rafters are handhewn and are roughly 5-1/2" by 7" at 4' on centers. Sheathing boards are 5/8" to 7/8" by 8" to 14". There are board nailers, roughly 1" by 4" to 8", attached to the underside of the sheathing (with modern cut nails) parallel to the rafters. Their function was to transfer concentrated loads from one sheathing board to its neighbors. The entire surface is dotted with nails and nail holes.

Door 306 is a 6' 3-3/8" by 2' 6-3/4" four-panel door with flat panels, no panel molding, and a plain board architrave. The room 301 sides of the panels are feather edged. Hinges are 2-1/2" by 2-1/2" cast iron butts with two knuckles (lift off), six holes, and later machine-made screws. There is no lock, latch, or pull on the door. The narrowness of the top and bottom rails and the proximity of pegs to the edges suggest that the door was reused from another location and cut down to fit this one. Paint samples taken from this door contain early layers of cream paint, unlike the Upjohn woodwork, which has a white primer and a gray finish coat. This paint further supports the contention that the door is reused (see section VI.C.1., paint samples 704 and 705).

Room 301 has no windows.

The only changes apparent in room 301 are those associated with its creation ca. 1850 from the original single attic room.

The preservation and restoration work recommended for room 301 includes the following items:

Lay 3/4" plywood over the joists at the west side of the room.

Apply plastic film vapor barrier to the floor using pressure sensitive tape and sealing carefully around all penetrations.

Lay fiberglass batt insulation, 10" to 12" thick.

c. Room 302 - Hall

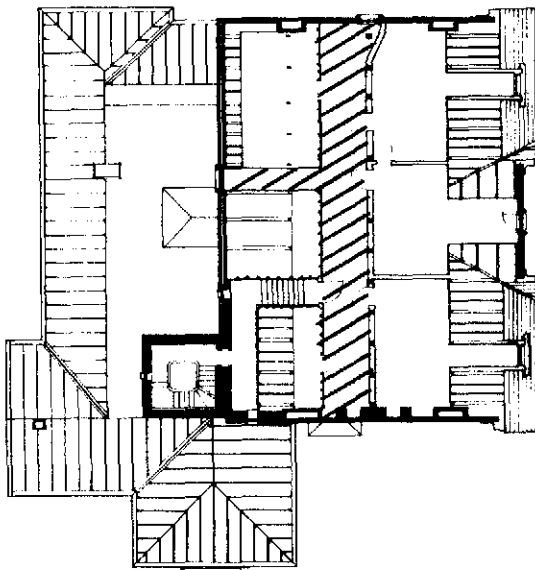

Room 302 is the T-shaped central hall of the third floor. The crossbar portion of the "T" is 6' 10" by 55' 4" oriented in a north-south direction, just west of the center of the building (see IP060). The stem of the "T" is 3' 1" by 12' 10" and extends in a westerly direction to window 307 in the west gable.

The walls are whitewashed two-coat plaster on circular-sawn wood lath except for the north end wall, which is three-coat plaster on brick, and the south end wall, which is two-coat plaster on brick. The baseboards are simple, planed 5-1/4" by 1" boards that were used as the

grounds for plastering and thus are exposed only 1/4" to 3/4". The west wall is 6' 7" high with three door openings and the opening into the stem of the "T." The east wall is 6' 5" high with three door openings and a double-curved offset at the north end to include window 305. The walls of the "stem" of the "T" are 7' 1-1/2" high.

The floor of the crossbar section and the eastern 4' 6" of the stem consists of 1-1/4" thick tongue-and-groove white pine boards of random widths ranging from 10-1/4" to 11-1/2". The flooring of the western part of the stem ranges from 6" to 9-1/2" in width. A 2' 8" by 4' 3" opening, 11' 3" from the north wall and adjacent to the east wall, has been patched with tongue-and-groove boards resembling those used in the west end of the "T" and other areas outside the lines of the knee braces (ca. 1850 work). This opening was the original attic access and served this purpose until ca. 1850. A 10" by 13" opening 2' 2" north of the stair opening contains a "Culver's Patent" register (see section IV.C.2.). According to interviews with Kenneth Campbell, he had this opening (and the one in the plaster ceiling below) made to ventilate the bathroom he installed on the second floor. The register is a historic one, moved from its original location (possibly room 119). At the extreme north end of the room, centered under window 305, is a small area that has no flooring. The floor joist and the cut-off tenon of the king post are exposed in this area. The king post was apparently removed so that window 305 could be installed and would light the room without obstruction. About 2' west and 6" north of this opening is an opening for a cast-iron vent pipe.

The ceiling of the crossbar section of room 302 slopes up from the east and west walls to a peak at 8' 4" above the floor and near the centerline of the room. The east slope follows the line of braces that connect the king posts to the rafters; the west slope follows the rafters. The ceiling of the "stem" portion of the "T" is flat and 7' 1-1/2" above the floor. All ceiling surfaces are whitewashed two-coat plaster on circular-sawn wood lath. It is interesting to note that 5 to 10

percent of the lath has a sash-sawn face. Perhaps planks were sash-sawn to uniform size before being fed into a gang circular saw to cut them into lath. In this way the sash-sawn top and bottom surfaces of the planks might have survived to confuse us. Plaster is missing from an area encompassing all of the south end of the ceiling to a point 15' out from the wall and from an area 2'6" by 1'6" around the vent pipe at the northeast corner. There are many smaller areas of missing or damaged plaster and cracks too numerous to itemize. On the east slope of the ceiling, north of center in the room, is a hatchway 2'7" wide and 3'7" along the slope. The opening is framed with simple planed boards that support a loosely fitted board-and-batten hatch. The frame and hatch are painted the same gray color as the baseboards, doors, and door architraves. Thus, the hatch was probably installed ca. 1850 to provide access to the roof and to the ridge space.

There are six doors in room 302. From south to north on the east wall, they are numbered 301, 303, and 305. From north to south on the west wall, they are numbered 306, 307, and 308. Door 301 is 6' 7/8" by 2'6" with six panels. A comparison of the lock stile with the hanging stile reveals that the lock stile has been cut down approximately 2". The panel molding is unlike any other found in the house. Since the bottom rail on similar doors is 9" to 10" high and the same piece on this door is about 2-1/2" high, one begins to suspect that this door was intended for use in another location, but later altered for use here. This suspicion is reinforced by the paint line ghosts of two rim locks, one on each side of the door. The dimensions of the one on the room 302 side could not be determined. The height of the one on the room 305 side was 4-1/4"; its length must have been about 6". Since the lock stile was cut down, the paint line is 4-1/4" from the edge of the stile. Neither of these lock ghosts has a corresponding keeper mortise in the jamb. The present lock for this door is a plate-type stock lock 6" by 4" by 1" with the numbers "116" impressed in the end grain. It is mounted on the room 305 side of the door. Immediately below this lock is a cast-iron thumb latch of the type usually found on ca. 1850 doors. The lockable latch lever is mounted on the room 302 side of the door. The apparent intent of this arrangement was to have a pull by which the door could be closed on the room 305 side, not to have the ability to lock someone into the room. The hinges are 3-1/2" by 2-1/2" five-knuckle six-hole cast-iron butts attached to the door with later machine-made screws. They are mounted to the south jamb, and the door opens into room 302. The architrave on the room 302 side is unique to this location. The architrave on the room 305 side consists of plain boards.

Door 303 is 6' 1-3/8" by 2' 11-1/2" with six panels, fielded on the room 302 side and beaded on the room 304 side. The panel molding is the same as that found on doors 134 and 135. Cast-iron butt hinges, 4" by 3" with five knuckles and six holes, are attached to the door and the north jamb with later machine-made screws. The hinge mortises on the south jamb indicate either that the door once hung on the opposite jamb or that the frame members were reused from another location. There are no corresponding mortises in the stile. The architrave molding profile on both sides matches that of doors 209, 210, 215, 216, 217, 305, and 308. On the north stile is the ghost of the "L" portion of an "HL" hinge. There are also ghosts of rim locks, 4" by 7"

and 4-1/2" by 3-1/4". All the above suggests that the door is not original to this location, hung elsewhere (probably the second floor), and was probably part of the ca. 1797 construction. The lock now mounted on this door is a cast-iron rim lock with molded rim. The back of the lock bears the inscription "P.M. & Co.," which has been traced to Pierpont Mallory and Company of New Haven, Connecticut, in the years 1843-1851 (Hennessy 1976, 145). In light of this information and the fact that the jamb bears no mortises to correspond to the other rimlocks, it seems very likely that this lock was installed when the door was moved to this location--probably ca. 1850. A cast-iron thumb latch similar to others on ca. 1850 doors is mounted on the room 304 side of this door.

Door 305 is a 6' 1-1/2" by 2' 7-3/8" six-panel door with beaded molding on the panels of both sides. The panel molding is the same as that on door 101, the front door. The architrave molding is the same as that on doors 209, 210, 215, 216, 217, 303, and 308. The architrave on the room 303 side is composed of plain boards. The hinges on this door differ from each other. Both are cast-iron butts with five knuckles and six holes. The top hinge is 4" by 3" with the legend "Ax & Sons" cast in recessed letters on one leaf. The later machine-made screws in both leaves and the earlier mortise on the door suggest that this hinge is not original to the door but may be original to its location here. The bottom hinge is 4" by 2-1/2" with the legend "Patent" on one leaf. It is attached to the door with early machine-made screws and to the jamb with later machine-made screws. When combined with the fact that there is no other mortise on the door, the screws provide evidence that the hinge was probably original to the door's first installation and was moved with it to this location. However, there are also paint ghosts on the door that might be interpreted as the marks of HL hinges, which would have predated the cast-iron butts. There is a cast-iron thumb latch, similar to those found on ca. 1850 doors, mounted on the room 303 side of the door. Its latch lever is missing. Paint lines and a patched keyhole indicate the former location of a 4-1/2" by 3-1/4" rimlock. There is no hole that might have served for a knob shaft; therefore, the lock was probably a closet lock--deadbolt, no latch. There is no mortise or ghost on the jamb corresponding to the rimlock ghost on the door.

Door 306 has already been described in conjunction with room 301.

Door 307 is 6'5" by 2'11" with six panels, beaded on the room 302 side and with panel molding only on the room 307 side. The panel molding on both sides matches that on doors 103 and 104. The architrave molding on the room 302 side matches that on doors 103, 104, 105, 107, 133, 137, and 211. The architrave on the room 307 side is the same as that on the room 203 side of door 207. The top hinge is a 5" by 3" cast-iron butt with five knuckles and ten holes identical to those found on doors 102, 103, 104, 107, and 136, thus suggesting a 1797 date. There is another hinge mortise on the jamb, but not on the door. The screws attaching the hinge to the door are early machine made; those attaching it to the jamb are later machine made. The bottom hinge is a 4" by 4" cast-iron butt with five knuckles and eight holes. It is attached to both door and jamb with later machine-made screws. This combination is identical to that typically found on ca. 1850 doors. A 5" mortise on the door suggests that the original bottom hinge matched the

top hinge. A cast-iron thumb latch of the type found on other ca. 1850 work is mounted on the room 307 side of the door. The door also has the ghost of a 4-1/4" by 6-1/2" rim lock and an open mortise for a mortise lock. The keyhole associated with the mortise lock is surrounded by the ghost of a shaped escutcheon identical to those found on doors 102, 103, 104, 107, 115, 127, 128, 130, 132, 134, 135, and 136. Thus, it seems very likely that this door was reused from a location in the first floor of the ca. 1797 part of the house.

Door 308 is a 5'11-1/8" by 2'5-1/2" board-and-batten door. The door consists of two wide boards, 7/8" thick and two battens 7/8" by 10" on the room 306 side. The architrave on the room 302 side matches the architraves of doors 209, 210, 215, 216, 217, 303, and 305. The room 306 architrave consists of plain boards. The hinges are 2-1/2" by 2-1/2" cast-iron butts attached to the south jamb. Previous hinges were attached to the opposite edge of the door. Near the present hinge side of the door are the ghosts of a 4" by 3-1/2" rimlock with no knob and a thumb latch with a solid-back plate.

Room 302 has two windows. Both are roundhead four-over-four double-hung sash with simple board architraves. Window 305 is 6' 5-3/4" by 2' 3-1/2". Window 307 is 5' 10" by 2' 3-3/4". Window 307 also serves as access to the flat roof of the one-story addition by means of an iron ladder. These windows need only normal maintenance to prepare them for many more years of service.

The only evidence of mechanical systems in this room is a 4" cast-iron vent pipe at the north end. It penetrates the floor just west of window 305, then crosses under the window and rises vertically through the ceiling and the roof. Straight runs of pipe are marked "Sanitary Co of America," "M," "18 lbs per ft.," "4xH", and "SaAco" surrounded by a diamond. Elbows are marked "15 lbs Eastham." Presumably this work was installed by the DeProsse family as part of the modern plumbing system.

The preservation and restoration work recommended for room 302 includes the following items:

Repair the plaster walls and ceiling.

Apply plastic film vapor barrier to the floor.

Lay fiberglass batt insulation, 10" to 12" thick.

In traffic areas, install insulation boards that can withstand foot traffic, and provide R30 insulation.

d. Room 303 - Servant's Chamber

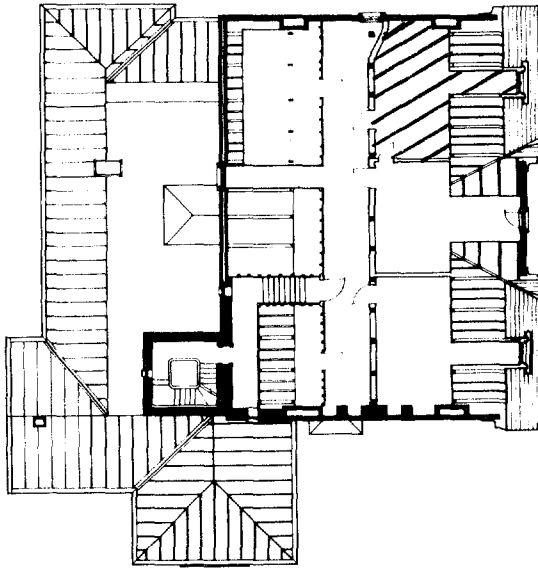

Room 303 is in the northeast corner of the third floor. It is essentially an 11'1" by 19'6" rectangle with a 3'1" by 9'8" dormer extension to the east. The northeast chimney protrudes 2'6" by 1'4" into the northeast corner and the north end of the west wall curves into the room parallel to the wall of room 302. The room was probably used as a servants' bedroom during the historic period (see IP061).

The walls are the standard whitewashed two-coat plaster on circular-sawn wood lath found elsewhere on the third floor. The baseboards are simple planed boards. The east wall is 4'9"

high; the west wall is 6'5" high. Openings have been cut in both sections of the east wall to allow access to the areas under the eaves. The north and south walls slope to a peak 8'6" high, 2'11" from the west wall.

The floor is covered with 1-1/4" tongue-and-groove white pine boards. Those in the western part range in width from 10-1/4" to 11-1/2". Floorboards in the dormer are mostly in the range of 10" to 12" wide, with one board of 1' 3" width.

The ceiling is whitewashed two-coat plaster on circular-sawn wood lath. The dormer ceiling is level at 7'2" above the floor. The east portion of the main ceiling area slopes, parallel to the roof surface, from a height of 4'9" at the east wall to a peak of 8'6", 2'11" from the west wall. The west part of the ceiling follows the braces between the king posts and rafters from 6'5" high at the west wall to 8'6" at the peak.

Door 305 has already been described in conjunction with room 302. Door 304 is a 5' 11-1/4" by 2' 1-3/8" two-panel door. The panels on the room 303 side are plain with an ovolo panel molding. The opposite side is fielded. No other door in the house has the same moldings. The architraves on both sides are simple boards attached with what appear (from observation of their heads) to be modern-type cut nails. The door is attached to the east jamb with 6-1/2" by 8" HL hinges. The door swings into room 303. The hinges and the door are painted white; the screws which attach the hinges to the jamb are unpainted. Therefore, the door with hinges attached, was probably brought here from another location.

Window 303 is a 5'10" by 2'9", roundhead six-over-six double-hung dormer window (see IP062). The muntin profile and sash-stop moldings are identical to those found on other ca. 1850 work. Normal maintenance work will prepare this window for many more years of service.

There is no discernible evidence of any mechanical systems in room 303.

The preservation and restoration work recommended for room 303 includes the following items:

Repair the plaster walls and ceilings; install covers for the access holes.

Apply plastic film vapor barrier to the floor.

Lay fiberglass batt insulation, 10" to 12" thick, on the floor.

e. Room 304 - Servant's Chamber

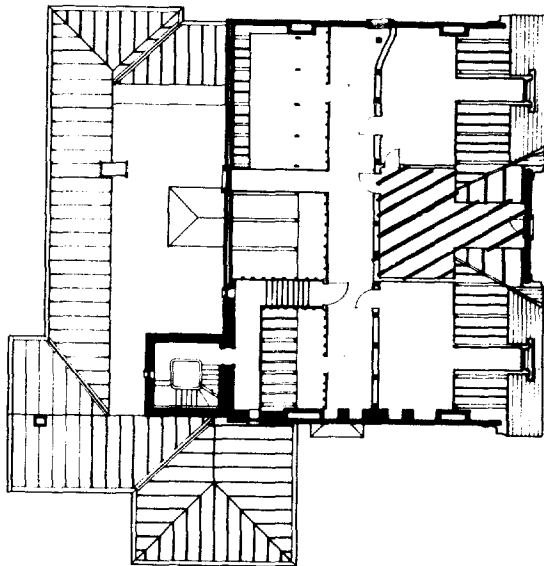

Room 304 is the central attic room on the east side of the house. It consists of a main rectangle 11'11" by 15'11" with a rectangular space 7'6" by 10'0" adjoining it to the east (located under the gable; see IP063). This room was probably used as a servants' bedroom during the historic period.

Walls, floor, and ceiling are identical to those in room 303 with the following exceptions: In the north wall of the gable extension, a hole was cut to allow access to the former roof surface now covered by the ca. 1850 gable roof. In the south portion of the east wall, a hole was cut for

access to the space under the eave. Rust stains on the ceiling and walls in this vicinity indicate the penetration of water through the valley of the roof above. The ceiling of the gable section is flat at 7'4" above the floor. The junction with the side walls is chamfered, with an extension of 1'3" down on the wall and 1'9" out on the ceiling.

Door 302 was originally window 302 and has been given both designations. Oral reports by Kenneth Campbell state that he converted this window in the east secondary gable to a door. This was done to provide access to the roof of the front porch that was built at the same time. The doorway was created by removing the window sill and the brick below it down to floor level and adding jamb and architrave extensions down to the floor. A Dutch door was created by removing interior sash-stop moldings, hinging the top sash, and adding a plywood door below. The interior architrave is a simple board with a rabbet similar to the other third-floor window architraves. There are many historic photographs that show the configuration of the former window. The brownstone sill and brackets are stored on site. The bricks from below the sill are also in storage. Other details can be restored from the surviving elements of this window and comparable elements of window 307.

The only mechanical equipment in this room is a call bell mounted on the north wall over door 304. The path of the wire can be traced about 1' east of the door frame to a hole where a pivot was located and down through staples to a hole in the floor. For further discussion of this system see section IV.C.5.

The preservation and restoration work recommended for room 304 includes the following items:

Restore window 302.

Repair the plaster walls and ceiling; install a cover for the access hole.

Apply plastic film vapor barrier to the floor.

Lay fiberglass batt insulation, 10" to 12" thick, on the floor.

f. Room 305 - Servant's Chamber

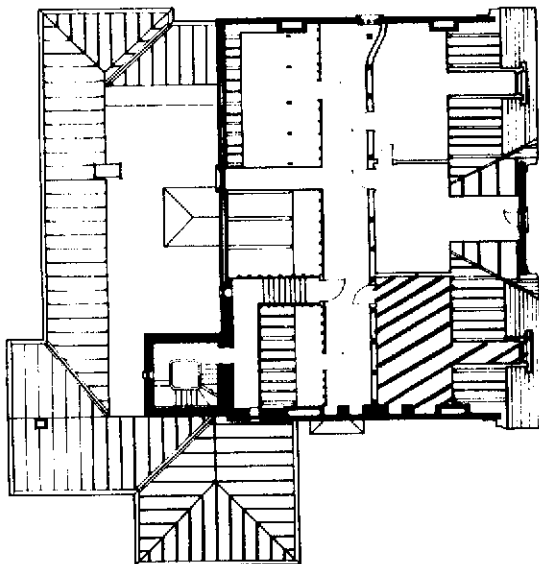

Room 305 consists of an 11'1" by 18'7" rectangle with a smaller (3'1" by 9'8") rectangular dormer extension appended to its east side. The room occupies the southeast corner of the third floor. It, too, was probably used as a servants' bedroom during the historic period.

The walls, floor, and ceiling are identical to those in room 303 with the following exceptions: There is an access hole cut in the south portion of the east wall for access to room 313. The south wall contains two arched niches that support the rerouted flues. Plaster is missing from most of the ceiling in the south half of

the room and from areas on the south wall where bricks were removed for inspection of the flues.

Door 301 has already been described in conjunction with room 302. Window 301 is identical to window 303. There is no evidence of any mechanical system in room 305.

The preservation and restoration work recommended for room 305 includes the following items:

Repair the plaster walls and ceiling.

Install a cover for the access hole.

Apply plastic film vapor barrier to the floor.

Lay fiberglass batt insulation, 10" to 12" thick, on the floor.

g. Room 306 - Attic

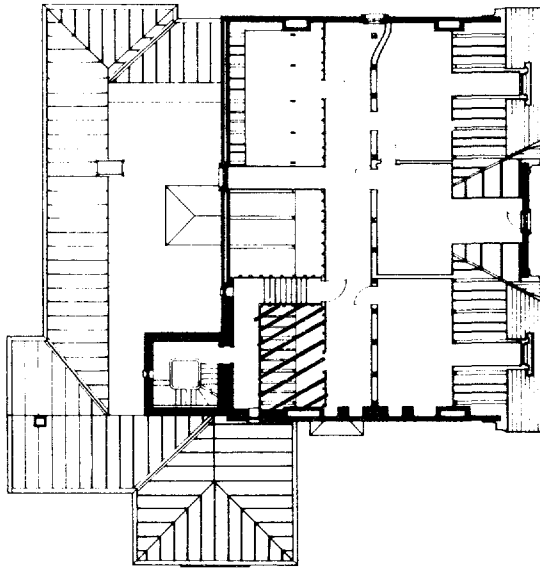

Room 306 is at the south end on the west side of room 302. It is 9'5" by 14'8". It was probably used for storage during the historic period.

The west, north, and east walls are exposed studs and the backside of circular-sawn wood lath and plaster. The east wall is 6'3" high, the west wall 2'9" high. The west wall transfers the load from roof rafters and floor joists down to the second-floor joists. Originally these loads were carried by the masonry west wall, but the ca. 1850 creation of room 307 required cutting the rafters and joists. The south wall is brick, the ca.

1797 chimney stack and ca. 1850 flues joining it from the west. The brick is plastered east of the knee braces, which continue the north-south line first described in the general description of the third floor. These braces have the same T-head wrought-iron nails on their east faces that were found in room 301. The nails are arranged in pairs, about 2" on centers vertically, with a space of 8" to 10" between pairs. This arrangement is thought to be the result of attaching boards to the braces with two nails per board per brace, each approximately 1" from the edge. On some braces there are two sets of nails where boards were butt-jointed at the brace.

Room 306 has 9-3/4" to 10-3/4" wide, tongue-and-groove floorboards, face-nailed to the joists in the area east of the knee braces. The area west of the knee braces has no flooring. The exposed floor joists are handhewn, measure approximately 6" by 9", and are spaced at approximately 4', with two intermediate 3" by 8" sawed joists in each space. Exposed between these joists is the top side of the plaster and split lath that compose the ceiling of room 210.

Half of the ceiling is open. West of the knee braces, the rafters and roof sheathing are exposed. East of the knee braces, circular-sawn wood lath survives but all plaster is missing. The bottom surface of the joists slopes from 6'3" high at the east wall to 2'9" high at the west wall.

There are no windows. Door 308 has already been described in conjunction with room 302.

The preservation and restoration work recommended for room 306 includes the following items:

Replace the missing plaster.

Lay 3/4" plywood over the joists at the west side of the room.

Apply plastic film vapor barrier to the floor.

Lay fiberglass batt insulation, 10" to 12" thick.

h. Room 307 - Hall

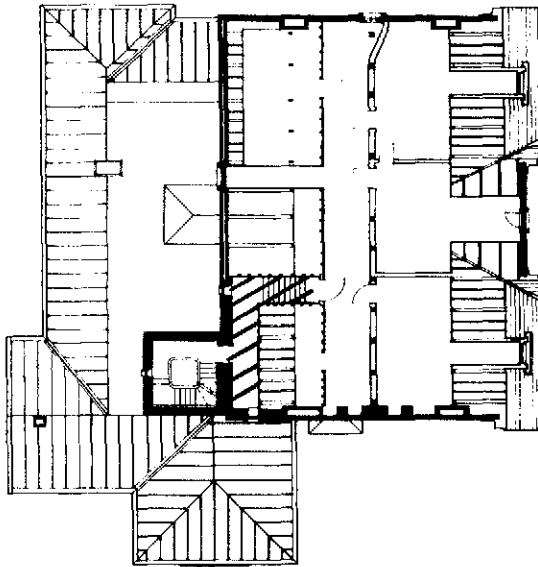

Room 307 is in the southwest corner of the third floor. It is L-shaped, with one leg 3'9" by 19'0" adjacent to the west exterior wall of the 1797 portion of the house (see IP064) and the other 3'7" by 9'1" projecting eastward from its north end (see IP065). This latter leg contains nine risers that connect the main area of the third floor with the lower level of the passageway and the adjacent landing to the tower stair (room 308). This room was created in the course of the ca. 1850 construction to provide access to the third floor from the new tower stair, thus allowing the earlier stair in the room 203 area to be removed. Its configuration

was dictated by the ca. 1797 roof construction, which limited the height of the ceiling of the western, passageway part, and the ceiling over the stairs.

The west and southwest walls are a mixture of two-coat and three-coat plasters on brick. Three-coat plaster is found where the exterior brick walls of the ca. 1797 house were not disturbed in the ca. 1850 construction. Two-coat plaster is found around the door and windows that were inserted ca. 1850 and on the ca. 1850 infill of the former window opening in the vicinity of door 309. This former window opening is indicated by the cutoff end of a handhewn wood lintel still embedded in the masonry south of door 309 about 4' above the floor. The other walls are two-coat plaster on circular-sawn wood lath attached to wood studs. All the plaster surfaces were whitewashed. The areas of three-coat plaster also carry the paint layers from earlier paint schemes in room 210. Also on the west wall between door 309 and window 311 is a vertical mark that is the only remaining evidence in this room of the ca. 1840 partition between rooms 210 and 206.

The floor of room 307 is composed of 6" tongue-and-groove blind-nailed boards. The stair risers and treads are single boards approximately 1" thick.

The ceiling is whitewashed two-coat plaster on circular-sawn wood lath. The western part of the room has a level ceiling about 6'1" above the floor, requiring notches in the rafters, and the ceiling over the stair is attached directly to the rafters.

Room 307 has two doors--door 307, already described in conjunction with room 302, and door 309, which connects to room 308,

the tower stair. It is a four-panel door 6' 1/4" by 2' 4-3/4" with panels 9" wide, top panels 2'8" high and bottom panels 1'5" high. The panels are flat on the east side and embellished with the typical ca. 1850 panel molding on the west side. The hinges are 4" by 4" cast-iron butts with five knuckles and eight holes. A beveled cast-iron rim latch is mounted on the west side south stile.

Windows 311 and 315 provide light and ventilation to room 307. Both are tall roundheaded casement windows. Window 311 is 2'11-5/8" by 9-3/4", with three 9-3/4" by 6-1/8" lights arranged vertically. The jambs and the roundhead are splayed. The sash swings on two-knuckle cast-iron butt hinges on the south jamb. Window 315 is 5'2-3/4" by 1'3-7/8", with three lights 1'6-1/2" by 1'0" arranged vertically. It swings on two 2-1/2" by 2-1/2" cast-iron butt hinges with two knuckles and six holes surface-mounted on the east jamb. Since this window provides light to room 211 as well, its sill is well below the floor of room 307.

There is no discernible evidence of any mechanical systems in room 307.

The preservation and restoration work recommended for this room includes the following items:

Repair the plaster.

Apply plastic film vapor barrier to the floor and to the east and north walls up to the level of the third floor.

Install traffic-resistant insulation board on the floor and stairs.

Install R30 fiberglass insulation over the vapor barrier on the walls.

i. Room 308 - Tower Stair

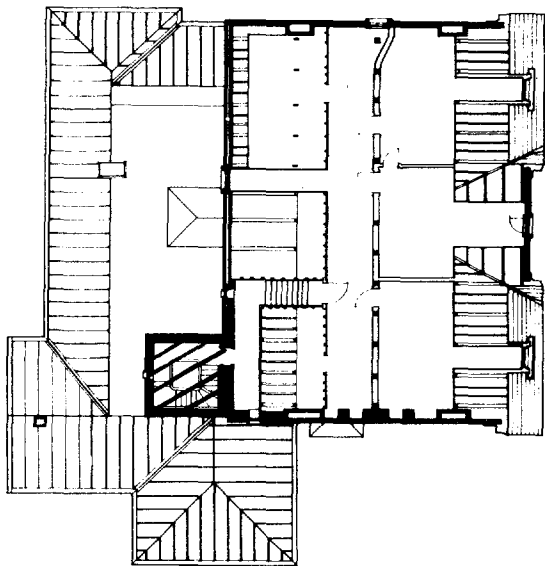

Room 308 is the third-floor level of the tower stair. It is a square room approximately 9'8" by 9'10" whose only function was to provide vertical access to all the floors in the house.

The walls are a whitewashed three-coat plaster on wood lath on furring strips attached to the brick walls of the tower. The baseboard at the landing along the north wall and along the stairs below is the typical profile used in the more formal areas of the Upjohn (ca. 1849) addition. Along the east wall, above door 309 and all the way to the belvedere, the baseboard is the simple cavetto type found in the

less formal areas of the Upjohn addition. There is no crown molding at the juncture of walls and ceiling.

The floor consists of a landing at the level of door 309 (the lower level of room 307) and then a series of straight runs of stairs, winders, and landings up to the belvedere. The landing is about 2'7" wide and continuous across the north wall of the tower, with a 3'2" ell along the west wall. The tower stairs above this landing consist of a straight run of five risers to the southeast corner, which is turned by two winders; another straight run of four risers along the south wall to a landing in the southwest corner; another riser to a landing along the west wall and north wall to a point just east of window 312, where two more risers lead to a landing in the northeast corner; five risers to a landing in the southeast corner; a winder and a straight run of five risers and two winders in the southwest corner; and a final straight run of three risers to the fourth floor--a landing that runs continuously along the north wall of the tower. The handrail and balusters of this section of the tower stair is the same as that for the sections of stair previously described. The handrail is continuous without newel posts. Treads and risers are all single boards approximately 1-1/8" thick. The treads generally extend under the adjoining riser, and the joint is secured by wood screws. The structural support for the stairs is described in section IV.C.1. The floorboards on the landings are tongue-and-groove boards, varying from 2-1/2" to 4-1/2" wide.

The ceilings of this space are whitewashed two-coat plaster on wood lath attached to irregular nailers on the underside of the stair structure. The finished plaster follows the landings, straight runs, and winder portions of the stair in one smooth continuous surface with gradual transitions between areas of different slope and around corners. Some of this plaster has been damaged by water that penetrated through the tower deck. One already damaged area of plaster and lath was completely removed to allow an inspection of the stair structure (see IP-068, 069, and 070).

Door 309 has already been described in conjunction with room 307. Windows 312, 313, and 314 are 3' 9-3/8" by 10-1/8" roundhead casements with four 6" by 9-3/4" lights each. All are hung on 2-1/2" by 2-1/2" cast-iron butt hinges with two knuckles and six holes, mortised into the sash and surface-mounted on the jambs. Window 313 is centered in the west wall of the tower 1' 6-3/4" above the third-floor landing and about 1'4" above the sheet metal roof of the addition. Windows 312 and 314 are centered on the north and south walls, respectively and both are about 5'9" above window 313.

There is no evidence of any mechanical systems in room 308. Of course, one can make a very strong case for the idea that the whole tower served as a very effective system for natural ventilation.

The preservation and restoration work recommended for room 308 includes the following items:

Repair or replace all damaged or missing plaster or lath.

Install a transparent barrier (of acrylic sheet) at the third-floor level to reduce heat loss through the tower, while maintaining visual continuity for visitors observing the tower stair from the first floor.

j. Rooms 309/310/311/312/313 - Attic

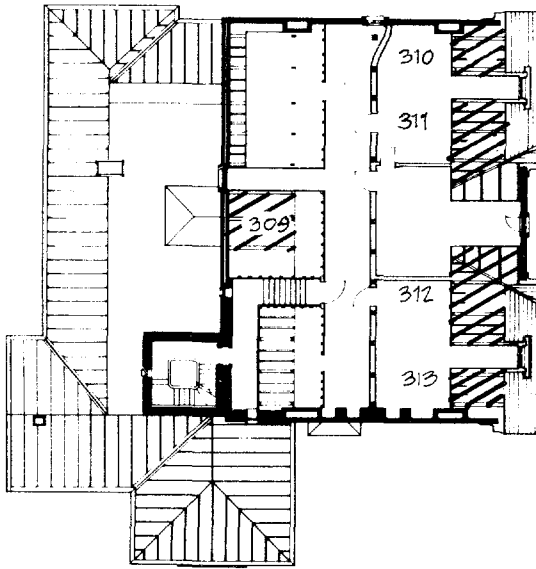

These rooms are not really rooms at all inasmuch as they were not intended for regular access. In fact, access was not possible until access holes (generally 1'6" by 2'0") were cut in the lath and plaster walls of the adjoining rooms.

The walls of these rooms were the unfinished back side of the lath and plaster walls of the adjoining rooms, except for the north wall of room 310 and the south wall of room 313, which were the exposed brick of the north and south gables, respectively (see IP066).

The floors of all five rooms are unfinished--the exposed joists and wood lath and plaster of second-floor ceilings. The sole exception is the area of room 309 east of the line of knee braces. In this area the ca. 1797 flooring survives.

The ceilings in all cases are the exposed rafters and roof sheathing.

There are no windows or doors in any of these "rooms," nor is there any evidence of mechanical systems.

The following items of work are recommended for rooms 309, 310, 311, 312, and 313:

Install 1-1/4" tongue-and-groove flooring over the exposed joists.

Lay a plastic film vapor barrier over the floor and fiberglass batt insulation over the barrier.

Install simple board frames around these openings to receive 3/4" plywood access doors to be held in place by turn buttons.

5. Fourth Floor - Tower Stair

The fourth floor consists of one space only (room 401)--the highest full-width landing in the stair tower and the space between it and the belvedere deck. Vertical circulation is the only conceivable use this space could ever have had. The room is 9'10" on its north-south axis and 9'8" on its east-west axis.

The walls of room 401 are whitewashed three-coat plaster on wood lath over furring strips attached to the masonry walls of the tower. The baseboard is the simple cavetto profile found in other secondary spaces of the ca. 1850 addition. There is no cornice molding. The handrail and balusters match those in rooms 308 and 212.

The floor consists of individual 1-1/4" boards for treads and risers and tongue-and-groove boards ranging from 2-1/2" to 4-1/2" wide. The configuration of the landings and stairs is as follows: A continuous landing spans the north side of the room; from its east end it continues a short distance to the south before a straight run of four risers, three winders in the southeast corner, and a final straight run of six risers lead to the belvedere deck. All balusters are present except for one on the southward extension of the fourth-floor landing.

The ceiling of this space is the flat underside of the belvedere deck. It is whitewashed plaster on circular-sawn wood lath attached to the joists of the belvedere deck. The plaster was severely damaged by water penetrating through the deck and through the ledges at its east and west sides. This same water penetration caused a near failure of the belvedere deck by enabling wood-destroying fungi to attack the joists. In the summer of 1980 this situation required the emergency insertion of a wooden girder to support the joists and a temporary roof covering over the deck to prevent further water penetration. An L-shaped opening in the southeast corner of the ceiling provides access to the belvedere. The opening is framed with a board fascia that turns the corners with curves of about 6" radius.

There are no doors in room 401 except for the hatch leading to the belvedere. It will be described in conjunction with room 501.

Windows 401, 402, and 403 provide light and ventilation for room 401. Windows 401 and 403 are centered on the north and south walls respectively just above the fourth-floor landing. Window 402 is at the center of the west wall below the last run of stairs leading to the fourth-floor landing. Thus, it is actually in the third-floor space. Since there was already a window with a 300 series number (313) on the west wall of the tower, it was decided to give this window a 400 series number. All three windows are 3' 9-3/8" by 10-1/8" roundhead casements with four 6" by 9-3/4" lights each. All are hung on 2-1/2" by 2-1/2" cast-iron butt hinges with two knuckles and six holes, mortised into the sash and surface-mounted on the jambs.

There is no discernible evidence of any mechanical equipment in the room.

The preservation and restoration work recommended for room 401 includes the following items:

Repair or replace all damaged or missing plaster and lath.

Whitewash plaster surfaces.

Replace missing balusters, repair the railing, and tighten loose joints to make the rail assembly more secure.

6. Fifth Floor - Belvedere

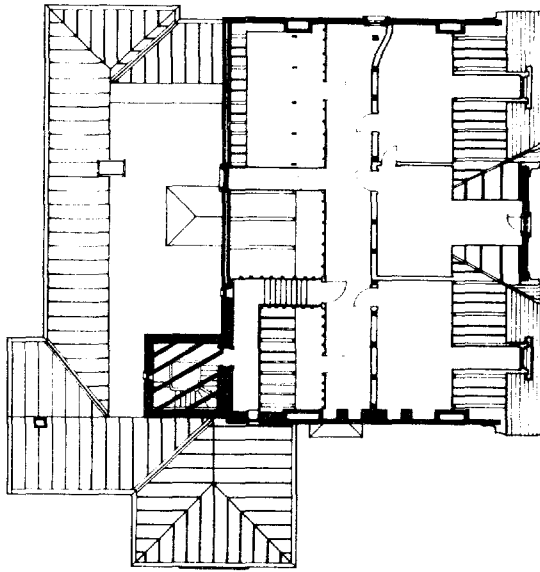

Room 501 is the open-air belvedere at the top of the ca. 1850 Italianate tower. The term "belvedere" is used because the only apparent historic function of the space was as a vantage point from which to enjoy the view of the Hudson River valley and the Catskill and Berkshire mountains.

The north and south walls are of solid brick construction with painted wood paneling as the interior finish. These walls carry roof loads down to the stronger, four-walled section of the tower below. The east and west walls are open with nonload-bearing columns at the middle of two arched openings and handrails

supported by urn-shaped turned balusters that are supported by bottom rails. The balusters are arranged in groups of four in each of the four arched openings--a total of sixteen balusters. Above the arches are composite wood beams that transfer rafter loads to the brick north and south walls.

The floor of room 501 consisted of two layers until August 1980, when the top layer was carefully documented and removed by the park maintenance staff. The top layer was covered with flat-seam sheet metal; some of the sheet metal pans were 20" by 28"--a size not available in 1850 (Waite 1971, 14). The surface sloped from a central north-south ridge down about 8" in a horizontal run of 4'8". Sheathing boards were aligned in a north-south direction and attached to the sloping rafters with both cut and wire nails (see IP067). The rafters were attached to the lower floor with wire nails. A hatch, approximately 4'6" by 2'6", covered the access opening at the southeast corner.

The lower (historic) layer of the floor is covered with 14" by 20" terne-coated iron pans over a virtually flat wooden floor deck. This metal covering was painted the same dark brown color as the wood trim. In this original paint layer are circular ghosts indicating the former locations of balusters (see IP068). There are five of these ghosts in each arched opening and a 9-1/2" square opening at the center of each side where the columns are located. Baluster bases are usually square, but there is documentary evidence in a letter dated May 13, 1980, from Smith Thompson Van Buren to Richard Upjohn that corroborates the evidence that they were round: "Are the caps and base of the baluster which you sent me square or round? They have been turned round--which is thought by one of the workmen (the only one good for anything) to be wrong" (Upjohn Papers). The east and west edges of this covering are turned down over the top half of the wood nosing and face-nailed with cut nails. The north and south edges are flashed up the

inside walls 2" to 6" with separate sheets of terne-coated iron that are bent at a right angle, soldered to the face of the flat covering (no lap seam joint), and fastened with cut nails to the wall surface. A trapezoidal opening at the south side of the deck and off center toward the east measures 5'9-3/4" along the south wall. The east and west sides are perpendicular to the south side and measure 4'1" and 3'5-3/4" respectively. The angled north side measures 5'10-1/2". This opening is framed by a 1-1/2"-high, 1"-wide curb with sheet metal covering the top and outside face only. The sheet metal is attached to the top of the curb with cut nails. At the south side, the curb is separated from the wall by a 2"-wide "gutter." Ghosts of hinges in the paint on the south wall suggest that the cover for the stair opening pivoted at its south edge and swung up against the wall. No evidence that would indicate how it was secured in either the open or closed position has been found. The cover itself is missing. The historic sheet metal covering is punctured by numerous nail holes because of the deck that was added later. These holes could be patched by soldering small pieces of sheet metal over each hole, and rusted and worn pans could be repaired or replaced, but the resulting patchwork would require constant maintenance. The deck is subject to severe weathering conditions. If a new metal decking with identical pan configurations were applied over the historic sheet metal, the historic covering would be preserved, albeit with more nail holes, and the park could be assured of having a good roof for many years to come.

The ceiling of room 501 is about 9' 6" above the floor. It consists of painted wood tongue-and-groove boards with one edge beaded. The boards are blind-nailed to ceiling joists, which also serve to tie together the roof rafters. At the north side of the ceiling, just east of center, is a hatch that provides access to the loft space and, through another hatch, to the top of the tower roof. A 2" by 6" joist spans the room from east to west at about 6'8" above the floor and supports a cast iron bell. The bell is inscribed "3" and the yoke is inscribed "CA[H]ILL." There is no indication of a date on the bell. However, the yoke is attached to the joist with wire nails. The supporting joist is attached to east and west walls by wire nails. No evidence of an earlier bell or its support was found.

The only door in room 501 is the previously described floor hatch that provides access to and from the tower stair.

There are two fixed windows in each of the brick supporting walls for the tower roof. On the north wall are windows 501 and 502, and on the south wall are windows 503 and 504. All are tall, roundhead windows. Sash are 8'1" by 1'4" with five 12" by 18" lights. The masonry openings are 8'5" by 1'8".

The only mechanical device present is the bell. A hole in the later floor deck was drilled to allow the passage of a bell rope into the tower stair and down to the first floor so that the bell could be rung without climbing the tower stairs.

The preservation and restoration work recommended for room 501 includes the following items:

Remove the bell and supporting joist.

Install a new sheet metal covering to match the historic floor deck.

Fabricate and install a new hatch cover and raised curb at the stair opening.

Restore the balusters to their original configuration and mount them on sheet metal brackets as shown in drawings; fabricate four new balusters.

Fabricate and install new bases for the columns.

C. Utilities and Structure

1. Structural System

On April 9 and 10, 1979, James Mayo, civil engineer, and James J. Wolf, structural engineer, Denver Service Center, conducted a field investigation. This section is based on their investigation of the structural integrity of the building and recommendations for its rehabilitation. The design calculations used are based on the New York State Building Construction Code, National Forest Products Association's National Design Specification for Wood Construction, and the Uniform Building Code. The "Interpretive Prospectus" was used to provide some indication of expected use.

Although many areas of the floors and walls are open for limited access, only portions of the attic and first-floor framing were accessible for a thorough visual examination. Most of the framing seen is in good condition and is eastern white pine (Pinus strobus). This report assumes that the members or portions of members not readily accessible are eastern white pine and are in good condition.

a. Main House Roof

The present roof, built ca. 1797, consists of sawn rafters and board sheathing. The roofing over the sheathing, which is only temporary, is asphalt rolled roofing. A small portion of slate remains in the northwest section. The gables and dormers were added in 1849. The gable rafters rest directly on the roof sheathing and not necessarily on the main house rafters.

The roof was found to be leaking, especially around the chimneys. The leaks have since been corrected with the installation of a new roof, flashing, and gutters.

The sheathing is 5/8" to 7/8" boards with an average span of 4'. A number of boards are rotted and split, and some have already been replaced in previous roof repairs. Most of the sheathing sags between the rafters, some by as much as 1", and deflects noticeably under the weight of a worker. The boards are peppered with nail holes from earlier roofing. In its present condition, and especially with the 4' span, the sheathing does not meet the loading requirements of the New York State Building Construction Code. The expected 100-year storm for this area will apply a 30 psf load. The only time that this loading might have occurred was during the blizzard of 1888. The allowable load (based on 1/120 deflection) for 5/8" sheathing in good condition is 17

psf, for 3/4" sheathing is 29 psf, and for 7/8" sheathing is 46 psf. The 5/8" sheathing is totally inadequate, and the split and rotted areas render the other existing sheathing an unreliable base for the roof, which must protect a resource of national importance.

It is recommended that the sheathing be repaired by adding new 3/4" plywood or 5/4" by 4" wood nailers at 5-1/2" centers directly over the existing sheathing. This would save the historic board sheathing and the gables would not have to be rebuilt. The original roof line, however, would be raised. This can be compensated for by a change in the height where the shingles meet the raking board copings and the gutters.

New blocking should be added under the gable rafters as needed to provide better support.

The rafters that were accessible for inspection are northern pine; others are assumed to be of the same material. The rafter sizes vary, with an average width of 5.65", average base depth of 8.15", average ridge depth of 6.34", and average spacing of 4' face to face. Based on these averages, the rafters are adequate to withstand the expected 100-year snow load. The maximum probable deflection is 1/2".

Visual inspection revealed that most of the rafters were in good condition. Areas where rot was apparent can be corrected by scabbing or patching. Missing knee braces should be replaced. The rafters are attached to the floor joists by a pinned mortise and tenon joint. As a result of cornice alterations presumed to have taken place in 1850, the pin is located too near the ends of the members to provide a satisfactory joint. It is therefore recommended that new plywood gusset plates be added to strengthen the joint (see IP069).

One rafter was cut short when the front gable was added on. The header used was 5/4" x 6". While this is not an adequate header, it is recommended that, because of the short length of the rafter and the destruction of historic fabric that would be required to replace it, no change be made to the header.

b. Upjohn Addition Roof

The addition roof consists of sawn rafters and board sheathing. The roofing of the flat section, which was replaced in 1978, is terne-coated stainless steel. Roofing on sloped surfaces, repaired in 1978, is the original 1850 terne-coated iron. The rafters rest on two trusses and masonry bearing walls.

The sheathing is 5/4" boards with an average span of 2'. This sheathing is adequate, and no further reinforcing need be done.

The rafters are rough-sawn, measure 4" by 5", and are spaced 24" on center. These rafters are adequate to meet the expected snow loading, and no further reinforcing is needed. The park has already done the necessary repairs in areas where rot is present.

The exposed stud walls that support the rafters are constructed of rough-sawn 4" by 5" timbers (see IP056 and 070). These structures transfer the loads from the rafters to floor joists and bearing walls below. No reinforcement is necessary.

c. Floor Framing

For unlimited visitor loading, the floors should be capable of supporting 80 psf, and the associated moments (M), deflection (A), and shear (V). The floor framing is generally inadequate for unlimited visitor loading. The governing criteria for many of the members is deflection. Limiting floor deflection is important because excessive deflection can cause the historic plaster ceiling below to crack. The remaining members have mortise-and-tenon ends, and their capacities are limited by shear stress at the ends. This occurs because the member area has been greatly reduced by the notches at the ends. This report assumes that the notches reduce the member depth by one half. There are three reinforcing alternatives:

(1) No Action - This alternative does not disturb or destroy the historic fabric, however, it is the most restrictive for visitor use. This alternative is only recommended where the existing structure is adequate for the limited use proposed.

(2) Minimum Intervention - In this alternative, the shear problems would be corrected with the addition of shear connectors at the affected mortise-and-tenon joints. Either the historic floor or the historic ceiling would have to be removed at the joist ends to provide access. The structural capacity would be raised by this intervention; however, the framing would still not be adequate for unlimited visitor use. This alternative is recommended where required to make the structure adequate for the proposed limited use.

(3) Full Reinforcement - Besides shear connectors at all mortise-and-tenon joints, designated members could be reinforced. This could be done by scabbing wood or steel to the existing joist or by adding new joists. Removal of an entire floor or ceiling would be necessary to do this. This alternative is not recommended because limiting use of the building would eliminate the need for full reinforcement.

d. Third Floor

The third-floor framing (except for room 307) consists of 6" by 9" main joists spaced 48" face to face with two intermediate 3" by 8" joists. Without reinforcing, this floor is not adequate for unlimited visitor use (see table 1). The third floor would only be adequate for very light storage.

Since there are no mortised and tenoned joints, the minimum intervention alternative is not possible. Full reinforcement is possible, by reinforcing the existing joists or by adding new joists. This work is not recommended because of impact on historic fabric.

Table 1: No Action, Third Floor

<u>Room</u>	<u>Floor Area (square feet)</u>	<u>Percent of Area Applied</u>	<u>Maximum Allowable Uniform Load (psf) Due To</u>			<u>Number of People</u>	<u>Comments</u>
			<u>V DL + LL</u>	<u>△ LL</u>	<u>M DL + LL</u>		
302	376	.5	67	16	33	17	
303	245	.35	67	16	33	8	
304	231	.35	67	16	33	8	
305	236	.35	67	16	33	8	
307	68	.5	385	420	345	Unlim.	

e. Second Floor

The second-floor framing was accessible only through a limited number of areas where the floorboards were removed. An assumed framing plan was drawn up, based on the visual inspection of these areas.

Rooms 201, 205, 209, 210, and 211 have main, 6-1/2" by 8-3/4" handhewn joists spaced 3'8" on center with intermediate vertical-sawn 2-1/2" by 8-1/2" joists. The intermediate joists are not continuous, however, and they are tenoned into headers between the main joists. Some of the joists have been notched to accommodate plumbing (see IP071).

The west half of room 206 has vertical-sawn joists that are 2-1/2" by 7-1/2" and are spaced 1'4" on center. The ends are tenoned into a beam (size unknown) in the bearing wall. Since this area of floor was added after the original construction (see IV.B.3.), the tenons are elongated to allow them to be inserted in new mortises cut in the existing beams.

Rooms 207, 208, and the east half of 206 have 3-3/4" to 5" by 8" handhewn joists spaced 1'10" on center. The ends are also tenoned into a beam (size unknown) in the bearing wall. The bearing for the inspected tenons is only 1/2" to 5/8". This is not adequate for visitor use, but the recommended shear reinforcement would correct bearing deficiencies as well.

Without reinforcement, the second floor is not adequate for visitor use since the maximum allowable load ranges from 18 to 26 psf (see table 2).

Under the minimum intervention alternative, all mortised and tenoned joints would be reinforced. All notches would be repaired with a wood scab or steel plate. A header could be added to support the intermediate joists in room 205. This would help to reduce the deflection in these joists. All of these items would require only local disturbance of historic fabric (removal of 2'-wide section of flooring) and would raise the allowable load to a minimum of 41 psf (see table 3).

The wall between rooms 210 and 211 is a bearing wall that carries the floor joist loads from rooms 306, 307, a portion of 302, and a portion of the roof load. Since there is no wall in the first floor below, the second-floor joists must carry this load to the bearing walls. Additional reinforcement is needed to help carry this load. However, if the third floor was not opened to visitors and rooms 302, 306, and 307 were not used for storage, the floor framing in rooms 210 and 211 would not need reinforcement.

An alternative to reinforcing the entire second floor for unlimited visitor use would be to reinforce only the hall and rooms 206 and 207. The bedrooms (rooms 201, 205, 208, 209, and 210) would serve as interpretive displays with barriers installed at the doorways to protect against visitor entry.

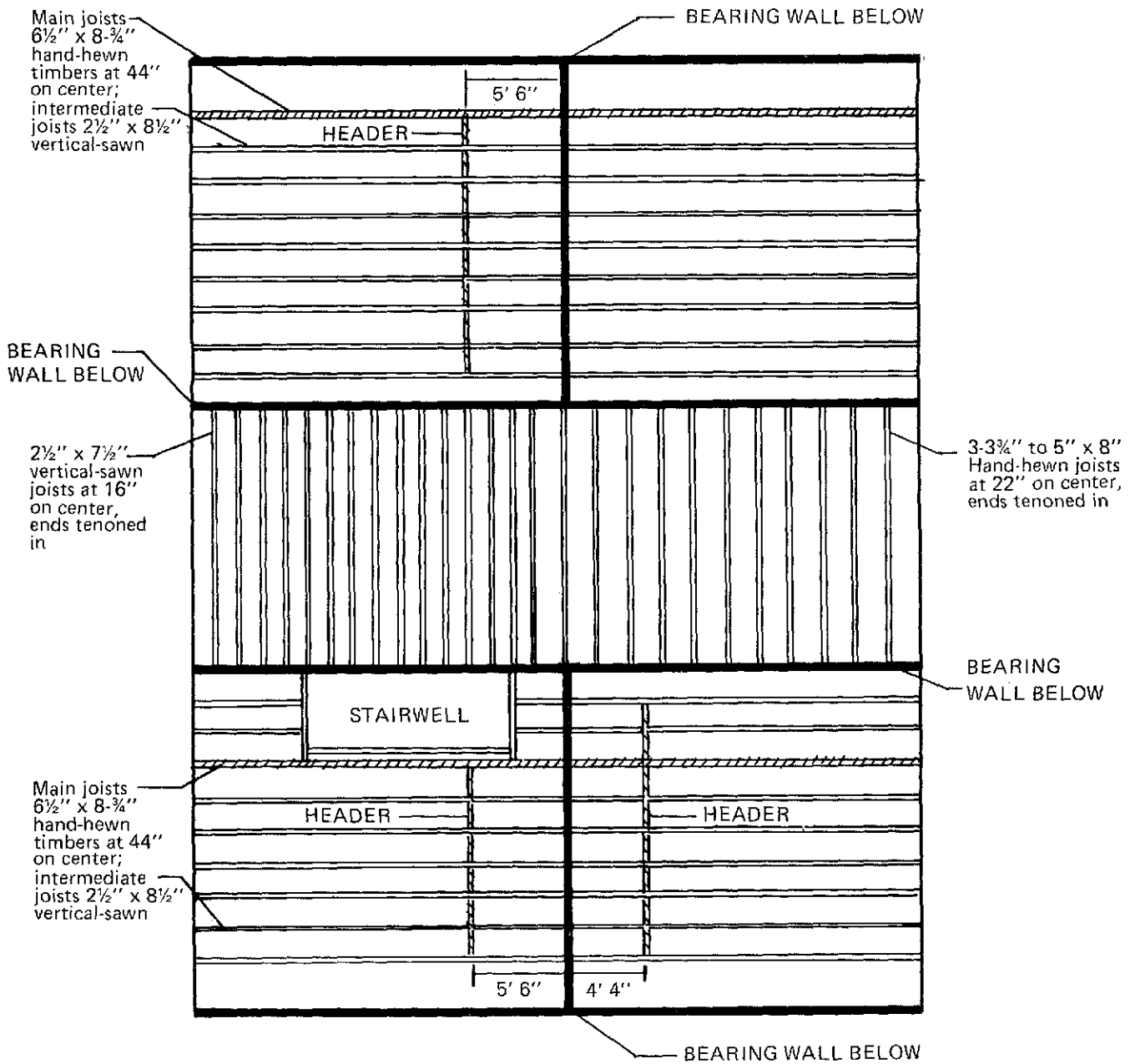

NO SCALE NORTH



ASSUMED FRAMING PLAN
MAIN HOUSE—SECOND FLOOR

Table 2: No Action, Second Floor

Room	Floor Area (square feet)	Percent of Area Applied	Maximum Allowable Uniform Load (psf) Due To			Number of People	Comments
			∇ DL + LL	△ LL	M DL + LL		
201	380	.35	18 73	43 48	68 94	6	Intermediate joist ends M & T Main joist
205	380	.35	54 145	18 48	38 94	14	Intermediate joist Main joist
206	330	.5	22	41	73	11	Ends M & T
207	101	.5	26	54	91	5	Ends M & T
208	199	.35	26	54	91	7	Ends M & T
209	378	.35	18 73	43 48	68 94	6	Intermediate joist ends M & T Main joist
210	240	.35	18 73	43 48	68 94		
211	76	.5	18 73	43 48	68 94	6	Intermediate joist ends M & T Main joist

Note: 210-211 joists carry floor loads from above. Any loads applied on third floor must be deducted from second floor allowable.

Table 3: Minimum Intervention, Second Floor

Room	Floor Area (square feet)	Percent of Area Applied	Maximum Allowable Uniform Load (psf) Due To			Number of People	Comments
			V DL + LL	^ LL	M DL + LL		
201	380	.35	72 73	43 48	68 94	33	Intermediate joist ends M & T Main joist
205	380	.35	72 145	43 48	68 94	33	Intermediate joist Main joist
206	330	.5	88	41	73	35	Ends M & T
207	101	.5	104	54	91	30	Ends M & T
208	199	.35	104	54	91	40	Ends M & T
209	378	.35	72 73	43 48	68 94	33	Intermediate joist ends M & T Main joist
210	240	.35	72 73	43 48	68 94	40	Intermediate joist ends M & T Main joist
211	76	.5	72 73	43 48	68 94		

Note: 210-211 joist carry floor loads from above. Any loads applied on third floor must be deducted from second floor allowable.

The recommended alternative is to install shear reinforcement in rooms 206, 207, and 208 only, limit visitation to 15 persons (including interpreter) at one time, and exclude visitors from all other second-floor rooms. Room 208 is included because of the lack of bearing area and the danger of tenons slipping out of mortises in the course of normal structural movement.

If any of the floors are to be reinforced, detailed and extensive inspection of the floor framing should be conducted prior to structural design to verify the assumed framing plan.

Attic room 213 has 2" by 11-1/2" floor joists at 18" on center. This floor is adequate for visitor use. However, because of areas where there is no flooring or inadequate headroom, it is recommended that the room not be open for visitor use. Based on structural considerations, the room may be used for light storage. However, in order to conserve energy, it is recommended that a vapor barrier and insulation be installed at the floor throughout this room.

f. First Floor

Most of the first floor framing was accessible for inspection. The exceptions were room 104, where the joists were not accessible, and rooms 105, 106, 109, and 119 where the joists were only partially accessible.

Rooms 101, 102, and 103 have 6" by 8" joists at 36" on center. These joists are assumed to be continuous across room 104. Some of the joists are racked or twisted, and most have been infested by powder-post beetle. Although the infestation appears to be inactive, the beams have been damaged about 1/2" deep on all sides. These joists are not adequate to handle unlimited visitor loads (see table 4). Therefore, it is recommended that the public not be allowed to enter these rooms.

The inside lintel across the east wall in room 002 is rotting and shows signs of powder-post beetle infestation. Enough sound wood remains, however, that this piece need not be replaced at this time.

Room 105 has 4-1/2" by 7" joists at 36" on center. Intermediate nailers have been added to help support the plaster ceiling. The joists are not adequate to handle unlimited visitor loads (see table 4). The park has installed temporary bracing to support the joists at center span; however, the mortise-and-tenon ends are still not adequate to support unlimited visitor loads. If the basement will not be open for regular visitation, it is recommended that the temporary bracing be made permanent and visitation in room 105 be limited to 15 persons at one time.

One joist was cut to accommodate a floor heater. This joist should be repaired with a scab. The first joist at the west end of the room is 3' 9-1/2" from the masonry bearing wall. Another joist should be added in this space to reduce the load on the present first joist. In the southwest corner of the room, the joists framed into a header that probably is from an earlier stairway. The size, condition, and connections of this member could not be determined; however, at

Table 4: No Action, First Floor

Room	Floor Area (square feet)	Percent of Area Applied	Maximum Allowable Uniform Load (psf) Due To			Number Of People	Comments
			∇ DL + LL	\triangle LL	M DL + LL		
101	336	.35	58	15	36	10	
104	384	.35	58	15	36	12	Framing not accessible; assumed continuous from 101
105	644	.35	31 16	161 22	160 43	27 8	Keep nonhistoric bracing Remove bracing ends M & T
106	378	.35	126	47	87	35	
109	239	.35	126	47	87	22	Framing not accessible; assumed continuous from 106
111	319	.35	146	130	169	Unlim.	Max span in addition
112	234					Unlim.	
114	127					Unlim.	
118	213					Unlim	
119	266	.35	82			38	End M & T
120	60					Unlim.	
122	36					Unlim.	
123	156					Unlim.	

least one joist was framed into the header. If the temporary bracing is made permanent, the header will not require reinforcement.

Rooms 106 and 109 have 5-1/2" by 9" joists at 36" on center. The joists were assumed to be continuous across both rooms. Intermediate nailers help to support the plaster ceiling. The joists are not adequate to handle unlimited visitor loads (see table 4). Therefore it is recommended that visitation to these rooms be limited to 15 persons at one time.

The Upjohn wing, rooms 111-123, is generally adequate to handle unlimited visitor loads (see table 4). The joists are generally 3" by 11-3/4" spaced at 16" on center. Some of the joists are mortised and tenoned into a header against the original house, and all rest on a wood plate at the outside wall. The mortise-and-tenon joints reduce the capacity of room 119, but limiting visitation to 30 persons at one time will obviate the need for shear reinforcement. A number of rotted joists were found in rooms 111 and 112; these should be replaced or scabbed onto.

One joist in room 123 rests directly on a window frame below. The window has been found to be nonhistoric and will be filled with masonry that will restore proper support for the joist.

A portion of the plate under the joists in room 114 is rotted. This should be repaired or replaced.

Although the powder-post beetle infestation appears to be inactive, it is recommended that the affected joists be checked periodically for signs of activity, i.e., insects, fresh sawdust, etc.

If the basement is not going to be used, then post and beam reinforcement can be added in the basement. This option would provide the most protection for the historic fabric.

g. Basement

The basement rooms have floors composed of lime mortar, wood, earth, cobbles, and/or brick.

Rooms 001, 002, 003A, and 004 have lime mortar and cobble floors that are adequate for visitor use. The holes in the floor in room 001 should be patched. Water was observed leaking in through the north wall of room 001 and at the windows in rooms 002 and 004. Regrading on the exterior will correct this problem.

Rooms 005, 006, 007, 009, 010, 011, and a portion of 012 have wood floors. The floors were found to be badly rotted in rooms 005, 007, and 011, and they will require substantial rehabilitation. In the remainder of the rooms the flooring was still intact; however, it is probable that rot does exist, especially in the sleepers. All rotted material should be replaced or stabilized before visitor use is allowed.

Water was leaking in through the south wall of room 007 and at the window in room 011 (see IP072). Regrading and proper rainwater drainage should correct these problems.

Table 5: Minimum Intervention, First Floor

Room	Floor Area (square feet)	Percent of Area Applied	Maximum Allowable Uniform Load (psf) Due To			Number of People	Comments
			∇ DL + LL	Δ LL	M DL + LL		
101	336	.35	58	15	36	10	
104	384	.35	58	15	36	12	Framing not accessible; assumed continuous from 101
105	644	.35	124 64	161 22	160 43	Unlim. 28	Keep nonhistoric bracing Remove bracing ends M & T
106	378	.35	126	47	87	35	
109	239	.35	126	47	87	22	Framing not accessible; assumed continuous from 106
111	319	.35	146	130	169	Unlim.	Max span in addition
112	234					Unlim.	
114	127					Unlim.	
118	213					Unlim.	
119	266	.35				Unlim.	End M & T
120	60					Unlim.	
122	36					Unlim.	
123	156					Unlim.	

Room 009 has an earth floor. The floor should be restored to its historic tongue-and-groove board flooring. Water was leaking in through the bulkhead.

Rooms 003 and 013 are paved with round river cobbles. Although the floor surface is structurally sound, the surface is very rough and irregular. Room 003 may have been originally covered with lime cement mortar; however, very little of this is left. The surface should be leveled with sand or mortar (restored to historic condition) to provide a smoother walking surface. Water was observed leaking in through the west wall of room 013. This room should be preserved as is and not opened to visitors.

Rooms 012 and 015 have brick floors that are adequate for visitor use.

The basement brickwork in some places is deteriorating. The mortar is soft and a number of salmon brick have been found. The arch between rooms 006 and 007, the window jamb in room 011, and the exterior wall in room 014 should be repaired. Approximately 20 percent of the wall surface should be repointed or repaired.

h. Tower Stairs

A typical section of the tower stair framing was exposed for inspection (see IP073, 074, and 075). This section consisted of a flat landing, a set of straight stairs, and a set of winder stairs.

With the exception of three landings that frame completely across one wall, all of the framing is supported by wood beams cantilevered out from the masonry. The cantilevers are not necessarily level or perpendicular to the wall (see IP073).

The landing framing is mortised and tenoned into the cantilever. The straight stair stringers are toenailed between two cantilevers. The risers and treads are connected with glue blocks and glue. The winder stairs do not use stringers; the treads are supported directly by blocking on the cantilever beams. The risers and treads are screwed together. Infestation by powder-post beetle was evident, although it did not seem active or severe.

There is no order or pattern to the size or spacing of the members. It is also impossible to determine how well imbedded the cantilever beams are without load testing each one. For these reasons, it is impossible to determine a structural capacity. It would probably be safe, however, to assume that the stairs are adequate for park personnel and for special visitors in small numbers (fewer than five at a time).

i. Main House Stairs

The main house stairs were not accessible for visual inspection. The stairs were checked with a "Stud-Finder" to locate the stringers. The stringers are supported just above the midpoint with a wall from below. The stairs did not deflect when used and should be adequate for visitor use.

The floor joist immediately adjacent to the stairs is normally reinforced to support the extra load from the stairs and from the stair header. This is not necessary on the second floor since the joist is continually supported by the wall. The joist in the first floor has no wall and is sagging. This should be corrected by adding two wooden posts, one at the base of the stairs and one just above the midpoint at the support wall.

j. Exterior

All the deteriorated mortar joints of the ca. 1797 portion of the house should be repointed. The Upjohn addition does not need to be repointed since it has recently been redone.

Windows 201, 202, 206, and 207 should be rebuilt. The jambs are rotted and lintels are cracked.

The timber under door 109 should be replaced or patched.

k. Recommendations

In summary, the following recommendations are made regarding the structural system:

Regrade the area around the house to provide better drainage away from the house.

Add new 5/4" by 4" nailers over the existing historic board sheathing on the main roof.

Repair the main house rafters as required; add blocking under the gable rafters.

Add new plywood gusset plates at all rafter/joist connections of the main house.

Repair the roof.

Do not reinforce the third floor; do not open the third floor to visitor use.

Add shear and bearing reinforcement in rooms 206, 207, and 208 on the second floor. Visitor barriers should be installed to allow visitors visual access to the rooms. This will allow fairly complete interpretation of the second floor and will minimize the amount of the historic fabric disturbed.

Make the bracing under room 105 permanent.

Repair or replace rotted and missing members in rooms 111, 112, 114, and 123.

Check periodically for signs of renewed activity by powder post beetle.

Patch and repair plaster as required.

Repair the basement floor as necessary.

Repair and repoint the basement walls as required.

Bar visitor access to the tower stairs.

Repoint the outside of the original house.

Repair the windows.

I. Conclusion

Although most of the house is inadequate for unlimited visitor use, no major problems in reinforcing the house are envisioned. Detailed information on member sizes, spacing, condition, and connections for those areas not accessible and the assumed framing should be obtained before any reinforcement is designed. Visitation should be strictly limited to no more than two groups of 15 (including interpreter) in the house at one time.

2. Heating System

The 19th century heating system at Lindenwald was comprised of fireplaces, a hot air furnace, and stoves. Fireplaces were the sole source of heat for the house until ca. 1855, when a hot-air furnace was installed. This furnace, still located in room 001, provided heat for the north rooms and central halls of the original house and for the entrance hall of the Upjohn addition. The remaining rooms, with the exception of the kitchen, were heated by fireplaces and later by stoves connected to the fireplace flues. The kitchen was heated by a cook stove, installed ca. 1850.

a. Fireplaces

There are 16 fireplaces at Lindenwald. They are located in rooms 005, 006, 007, 011, 101, 104, 106, 109, 111, 112, 114, 118, 201, 205, 209, and 210. In room 006, the cook stove has been built into the fireplace. When the cook stove was installed, part of the fireplace arch was filled in with brick. In room 005 the fireplace has been bricked in. The remaining fireplaces are open or have been opened since the National Park Service acquired the property.

The fireplaces in the 1797 part of the house originally had simple wooden surrounds and shallow fireboxes. Their flues ran straight up chimneys at the back of the fireplaces. The fireplaces in rooms 101, 109, 201, 205, 209, and 210 retain their original wooden surrounds. The fireboxes and flues in rooms 101, 109, and 210 have been rebuilt; in rooms 201, 105, and 209 they appear unaltered. In rooms 104 and 106 the simple wooden surrounds have been replaced with elaborate marble surrounds. Wooden nailers above the current marble mantels and repairs to the plaster walls around these fireplaces clearly indicate that the marble surrounds are not original. The fireboxes of these fireplaces have also been rebuilt.

When the fireboxes in rooms 106 and 109 were rebuilt, a system for bringing fresh air into the room and heating it was incorporated into their design. This system consists of an opening 4" in diameter in the exterior brick wall of the room directly behind the fireplace (see IP076 and 077). This opening allowed fresh air to pass into the base of a recessed area at the back of the firebox. This recessed area was covered by a metal plate, creating a chamber in which fresh air was heated (see IP078). This chamber was connected to a horizontal pipe 4" in diameter (see IP079), which carried the heated air into the room through vents located on either side of the fireplace. (See the fireplace fresh-air intake system illustration at the end of the chapter for explanation of the functioning of this system.) This system for heating fresh air with a fireplace is similar to one described by A.J. Downing in The Architecture of Country Houses (Downing 1850, 470). The alterations to the fireplaces described above were probably made by Van Buren ca. 1840.*

The fireplaces in the Upjohn addition have marble surrounds but do not have the fresh-air heating system found in the fireplaces in rooms 106 and 109. Such a system would not have been possible in these fireplaces because none of them were built into an exterior wall.

With the exception of the bathroom fireplace, which is described in detail under the section documenting the Lindenwald bathroom, the designs of the fireplaces in the Upjohn addition are not particularly noteworthy (see section IV.B. for details). What is interesting about these fireplaces is the way in which their flues run.**

The fireplaces in rooms 011 and 118 have the most straightforward flue arrangement. Their flues run virtually straight up into chimney 1. The flues from all of the other fireplaces in the addition run through the tower walls and into chimney 3 on the south side of the house (see the flue illustrations at the end of the chapter). The location and size of the tower makes the routes of these flues lengthy and complex. They run as follows (the fireplaces are identified by the number of the room in which they are located).

(1) Basement

(a) Fireplace 006

This is the fireplace into which the cook stove has been built. Its flue runs up behind the fireplace in room 111 and eventually joins the flue of this fireplace. How the cook stove smoke flues run into this fireplace is described below.

*See evidence for ascribing this date to the fireplace alterations in rooms 106 and 109 in detailed descriptions of these rooms.

**A bee smoker was used to send smoke up the chimneys of the Upjohn addition to help determine how these flues ran. Two openings in the main flues that run across the south wall of room 211 were used to plot the routes of the flues. These flues run roughly parallel, one above the other. The cap was also removed from chimney 3 to determine which chimney flue these main flues joined.

(b) Fireplace 007

The flue from this fireplace runs up behind the fireplace in room 112 and joins the flue from that fireplace. The flue from the bake oven, which runs off the east side of the oven, joins the flue of fireplace 007 at roughly a 45 degree angle at the height of the basement ceiling.

(c) Fireplace 009

Although this flue opening in the south wall of room 009 does not appear to be associated with a fireplace, its route is described here because it also runs into the chimney on the south side of the house.* This flue runs into the south wall of room 009 where it turns, at roughly a 90 degree angle, and runs up behind the bathroom fireplace in room 114. This flue joins the bathroom fireplace flue above its firebox.

(2) First Floor

(a) Fireplace 114

The flue from this fireplace runs straight up for a short distance, is joined by the flue from room 009, and then turns south at roughly a 90 degree angle. After turning, it runs in a southerly direction above the door between rooms 112 and 113, and joins the flue running up from fireplace 112.

(b) Fireplace 112

The flue from this fireplace runs straight up to roughly the height of the first floor ceiling. At this point, it is joined by the flues coming from rooms 007, 009, and 114. It then turns and runs above the door between rooms 111 and 113, through the south wall of the tower, and into the south wall of room 211. It is the upper flue in this room. From the opening in this flue, it continues to rise and run in an easterly direction, above the window. From there it runs into the south wall of room 302 and into chimney flue opening 1.

(c) Fireplace 111

The flue from this fireplace is joined, above its firebox, by the flue from the fireplace in room 006. It runs roughly straight up to the height of the first-floor ceiling, where it turns and runs in an easterly direction into the south wall of room 211. It is the lower flue in this room. In room 211 it runs under the window and into the south wall of room 210, where it is joined by the flues coming from the fireplaces in rooms 005, 109, and 210. From this junction it continues to run in an easterly direction up into room 302, where it joins chimney flue opening 2. Flues from the fireplaces in rooms 106 and 209 run into chimney flue opening 3. At present no fireplace flues run into chimney flue opening 4.

*This flue was probably used for some sort of hot-water heater or stove. For a detailed discussion of its possible use, see "Bathroom Heating and Hot Water," section IV.C.3.

Correspondence from Smith Van Buren on November 22, 1849, near the time these fireplaces and flues were built, reveals that they did not perform well. He says:

The flues from the wash-room, bed-room and bathroom have smoked so badly that the walls are entirely black, and the ceiling also of the bed-room destroyed (Upjohn Papers, NYPL).

Given the above-described routes of these flues, it is clear why they did not function efficiently.

The hot-air furnace is a Boynton furnace, patented August 22, 1854. This patent date and the inscription "Hon. M. Van Buren, Kinderhook, N.Y." on the sheet-metal door of the furnace indicate that it was installed at Lindenwald between 1854 and 1862, the year of Van Buren's death (see HP1 and 2). The patent of the furnace describes its construction as follows:

A fire chamber (a) of circular form, with an ash pit (b) below . . . above this fire chamber (a), and resting upon it is a dome shaped chamber (c), the sides of which are deeply corrugated; this chamber has a circular opening (C') at the top, and around, near its base, are six, more or less, openings, the number depending on the manufacturer's views, these openings extend outward and upward in radial pipes (d) terminating in a horizontal aperture forming the Joint X; above this joint there is a ring (e), surrounding the dome below its top, on the under side of which are downward projections (e') forming the lower side of the ring into a series of arches, terminating in circular bases that just fit on to the top of (d) at X: over the highest point of every other one of the arches, and midway between the Joint X, a curved pipe (f) extends up from the Ring (e): the several pipes (f) curve over the top of the dome, and join in a hub or short enlarged central pipe (g), that just fits onto the opening (C') on the top of the dome above named; on top of the hub (g) the exit smoke flue (h) fits. There is a puppet valve (i) within the hub, which when on its seat, covers the opening (C') at the top of the dome (c): it is hung on the end of an arm (i') having its fulcrum (i²), and is worked by a corresponding rod (i³) extending out through the side of the furnace: when this valve is open, there is a direct draft off through the top of the dome; but when closed the gases, after reverberating, and being consumed within the dome, are made to descend and pass off through the apertures at the base of the dome, and thence upcirculing in the ring (e), into and through the pipes (f), hub (g), and out at the exit pipe (h) (Patent 11,545, BPL).

The furnace is surrounded by a brick enclosure measuring 6'4-1/2" high by 7'2" wide, roughly square (see IP080). The enclosure consists of an inner and outer brick wall, with an air chamber between. It is pierced by eight openings. In its east wall are two doors, one above the other. The top door is the "feeder," through which the fuel is placed into the furnace (see IP083); the lower

door is the ash pit cleanout (see IP084). In its north wall are the opening for the smoke flue, which ran into the flue of a chimney in the north wall of room 001, and a large sheet metal door of hollow construction, about 2" thick, through which maintenance work on the furnace could be done. (On the inside of this door is written "Hon. M. Van Buren, Kinderhook, N.Y."; see IP081.) The other four openings are at the top of the enclosure. These are circular openings for the hot-air ducts that run to the first and second floors.

In the outer wall of the west side of the brick enclosure is an opening that measures 2' 1" wide by 11" high. Through this opening, cold air from room 012 enters the inner air chamber. The cold air passes through the inner air chamber and enters the furnace chamber through rectangular openings in the bottom of the inner wall of the brick enclosure. These openings are formed by bricks, stood on end, with the narrow side of the brick facing the furnace chamber. The cold air passes through the furnace chamber, where it is heated causing it to rise. It escapes, as hot air, through the circular duct openings in the top of the furnace chamber/brick enclosure (see IP082).

From the top of the furnace the hot-air ducts run in four directions (see the basement hot-air furnace illustration at the end of the chapter). Moving in a counterclockwise direction from the door in the north wall of the brick enclosure, the first duct runs in a westerly direction at an angle of approximately 30 degrees and opens into a register in the east wall of room 119. The second duct also runs in a westerly direction at an angle of approximately 80 degrees and opens into a register in the floor of the southwest corner of room 101. The third duct runs in a southerly direction at an angle of roughly 50 degrees and opens into a register in the floor of the north-west corner, room 105. The fourth duct runs in an easterly direction across room 001, rising at about a 5 degree angle into the southern end of room 103. In this room three ducts run off the main duct. One runs horizontally into a register in the baseboard of room 105, and another runs horizontally into a register in the baseboard of room 104. The third duct rises vertically into the closet in the north wall of room 206. There it terminates in three horizontal ducts. One duct runs into a register in the baseboard of room 201, and another runs into a register in the baseboard of room 205. The third duct runs into a register in the closet door of room 206. In the south walls of rooms 201 and 205, at a height of 7'11", are two 11" high by 10" wide rectangular openings. A metal box with a circular opening 5" in diameter was removed from the opening between rooms 205 and 208. This box and plaster patching around the opening in room 205 suggests that these openings may have had registers that allowed heat to pass from rooms 201 and 205 into rooms 206 and 208. No evidence of these wall registers has been found. On the other hand, these openings may have been created for flues for stoves in rooms 206 and 208.

The hot-air system at Lindenwald appears to have had three types of floor or baseboard registers (see HP3). One register is rectangular, measuring 8-1/2" by 12", with a scroll pattern grill. In its center is a circle that surrounds a star-shaped device that

turns to open and close the register. This register is marked "Culver's Patent" (see IP085). A patent for a hot-air register of this design was granted to David Culver of New York, New York, on August 10, 1848. Culver states in his request for a patent that

the nature of my invention consists in an improved mode of handling and operating the leaves of the register by which they can be opened, and closed, and adjusted to any required aperture (Patent 5,698, BPL).

These registers were used in rooms 105, 119, and 206.

The second register is circular, measuring 10" in diameter (see IP086). The openings are in the shape of a sunflower, and the register opens and closes by moving a small knob at the side of the register backwards and forwards. This register bears no markings. These registers were used in rooms 101, 104, 201, and 205.

The third register is also circular, measuring 14" in diameter. It is marked "patented March 16, 1852 and Jan 3rd 1854." The March 16, 1852, patent is for "Turton's Improved Hot-Air Register and Ventilator." Turton describes his invention as follows:

The nature of my invention consists in furnishing a crown wheel and gearing it directly to the fans by means of a pinion wheel, or section of the same, attached to each fan, by which means the fans are made to open and shut in an easy, accurate and uniform manner (Patent 8,811, BPL)

The January 3, 1854, patent is for an improvement on Turton's register. This patent was issued to Edward A Tuttle, who describes his invention as follows:

The improvement upon said William Turton's patent which consists in the improved method of maintaining the connecting rod in its proper position substantially as described, namely at the bottom by a prong or prongs of the rod inserted into and working in cast raised openings on the fans or valves, and at the top by a slot or otherwise in the register front together with the slide plate, by which arrangement the register is greatly simplified and cheapened in its cast (Patent 10,371, BPL).

Only one register of this type appears to have been used at Lindenwald. It was in the floor in the northeast corner of room 105.

All three types of registers are surrounded by marble frames. The ones for the rectangular registers are rectangular and measure 1'4" wide by 1'2-1/2" high; those for the 10" circular registers are square and measure 1'1"; and that for the 14" circular register is square and measures 17-1/2" by 17-5/8".

The rectangular and 10" circular registers are nearly identical to the hot-air registers found in the commanding officer's house, Springfield Armory, Springfield, Massachusetts, whose hot-air heating system was installed ca. 1847 (Stull and Vanderweil 1979).

The hot-air heating system described above is basically intact. The smoke flue that ran from the north side of the furnace into the fireplace flue in the north wall of room 001 has been removed. Some of the registers have also been removed; with the exception of the register in room 101, they are in storage at Lindenwald. The vertical duct and branches in room 103 and the closet above are missing and should be replaced.

This hot-air furnace appears to have been the main source of heat at Lindenwald until 1937, when a heating system using hot water was installed by the DeProsse family (based on an interview with Clementine DeProsse).

b. The Cook Stove

As noted above, the cook stove is built into the fireplace in room 006. It is made of cast iron and consists of a rectangular firebox and cooking surface and two ovens. The ovens are arranged one on top of the other at the right side of the cooking surface (see the north/south cookstove section illustration and IP087-90).

The stove's rectangular cooking surface probably had six potholes originally.* At present, all of these potholes and the panels that fit between them have disappeared; all that remains is the outside frame into which they fit (see IP089).

The back of this cooking surface is anchored into the brick wall of the back of the fireplace; its front rests on the cast-iron enclosure of the stove's firebox. This enclosure consists of two corner panels, which are decorated with raised gothic arches. The enclosure's double doors, which opened into the firebox, are missing. However, judging from the design of the oven doors, it would appear that they too would have been decorated with a single raised gothic arch and closed with a simple latch.

The stove's firebox contains a solid brick platform roughly 1'2" high. The distance between this platform and the stove's cast-iron cooking surface is 6". In the front of the platform is a recessed area in which the stove grate and ash pit are located (see the north/south cookstove section illustration). The overall size of the stove grate and the size of the space between the individual bars of the grate suggests that the stove burned coal. The flue for the firebox runs out its right side and into a chamber that surrounds the two ovens.

*See patent 34,120 issued to Moses Pond, Boston, Massachusetts, January 7, 1862, which has a cooking surface and firebox that are very similar to the one found at Lindenwald.

Above the stove's cooking surface is a sliding metal vent that is built into the earlier fireplace's flue. This vent was used to carry steam, smoke, and disagreeable cooking odors out of the kitchen.

The cook stove's ovens are roughly 25" wide and 19-1/2" deep (see IP090). The lower oven is 17" high and the upper oven is 18-1/2" high (see the east/west cookstove section illustration). A 4"-wide chamber (a) separates the two ovens. This is the chamber into which the hot air and smoke from the firebox pass. It is connected to chambers that line the left and right sides of the ovens--(b) and (c) for the lower oven and (d) and (e) for the upper oven. The upper oven also has a chamber surrounding its top (f); the lower oven does not have a comparable chamber at its bottom. The flue for the ovens runs out of the chamber (f) and into the flue of the earlier fireplace.

The interior of the ovens had sheet metal linings and cast-iron racks. The lining and racks of the upper oven are still intact; those of the lower oven have completely disappeared. The ovens were closed with pairs of cast-iron doors. Each door is decorated with two raised gothic arches and has a simple latch. The upper oven bears the markings "M. Pond's Union Range" and the lower oven "Applied For."

Above the cook stove's cooking surface and ovens is a rectangular piece of sheet iron 5'6" long and 4-1/2" wide. Its lower edge is beaded. It is built into the brickwork that surrounds the cook stove. In its center is an oval manufacturer's plate which reads as follows: "Manufactured by Moses Pond & C. No. 28 Merchants Row, Boston" (see IP083).

The cook stove appears to have functioned as follows: A fire was built in the fire grate. The heat and smoke from this fire circulated in the air space between the brick platform and cast-iron cooking surface, heating this surface. An opening from this air space ran into the chamber between the two ovens and was the source of their heat. From this chamber the hot air and smoke ran into the chambers, described above, that surrounded the ovens.* The smoke and hot air escaped from these chambers through a flue at the back of chamber (f).

The cook stove in room 006 was not only used for cooking, but for heating this room as well. Patches in the floor in room 111 and missing subflooring for this room indicate that excess heat from this room was used to heat room 111 through floor registers. No evidence of the type of register used in this room remains; however, this was a common means of distributing heat in the latter half of the 19th century.**

*Since the lower oven was heated from only three sides and hot air rises, it seems likely that this oven was used for warming rather than cooking.

**See section IV.B.2.k. dealing with the room 111 interior for restoration recommendations.

UNITED STATES PATENT OFFICE.

NATHANIEL A. BOYNTON, OF NEW YORK, N. Y.

HOT-AIR FURNACE.

Specification of Letters Patent No. 11,545, dated August 22, 1854.

To all whom it may concern:

Be it known that I, N. A. BOYNTON, of the city, county, and State of New York, have invented certain new and useful improvements in Air-Furnaces for Heating Buildings; and I do hereby declare the following to be a full and exact description thereof, reference being had to the accompanying drawing, in which—

10 Figure 1, is a vertical section of the furnace; Fig. 2, is a plan of the lower portion of the gas consuming chamber, with the side pipes, ring, and exit pipe from the point *x* *x* in Fig. 1, removed; Fig. 3, is a plan of the ring and exit pipes passing over the crown of the gas consuming chamber.

My improvements are made for the purpose of bringing together, in the most compact practicable form the largest amount of heating surface, consistent with convenient construction and a free and constant passage of air over the heating surfaces in all parts of the furnace, and at the same time the parts are so arranged as to shed all the ashes, soot, and other products of combustion that would otherwise tend to clog the pipes, back into the fire chamber, where all the combustible portions are consumed, and the rest pass off through the ash pit.

15 The construction is as follows: A fire chamber (*a*) of circular form, with an ash pit (*b*) below, are made like many others now in ordinary use; above this fire chamber (*a*), and resting upon it is a dome shaped chamber (*c*), the sides of which are deeply corrugated; this chamber has a circular opening (*c'*) at the top, and around, near its base, are six, more or less, openings, the number depending on the manufacturer's views; these openings extend outward and upward in radial pipes (*d*) terminating in a horizontal aperture forming the joint *x* *x* above this joint there is a ring (*e*), surrounding the dome below its top, on the under side of which are downward projections (*e'*) forming the lower side of the ring into a series of arches, terminating in circular bases that just fit on to the top of (*d*) at *x* over the highest point of every other one of the arches, and midway between the joint *x*,

the curved pipe (*d*) extends up from the ring *e*, the several pipes (*d*) curve over the top of the dome, and join in a hub or short enlarged central pipe (*g*), that just fits on to the opening *c'* on the top of the dome above *g*, and on the top of the hub (*g*) the exit smoke pipe (*h*) fits. There is a puppet valve (*i*) within the hub, which when on its seat, covers the opening (*c'*) at the top of the dome (*c*); it is hung on the end of an arm (*i'*), having its fulcrum (*i''*), and is worked by a corresponding rod (*i'''*) extending out through the side of the furnace; when this valve is open, there is a direct draft off through the top of the dome; but when closed the gases, after reverberating, and being consumed within the dome, are made to descend and pass off through the apertures at the base of the dome, and thence ascending in the ring *e*, into and through the pipes (*d*), hub (*g*), and out at the exit pipe (*h*). The air enters the furnace inclosure at brick (not shown in the drawing) and when heated passes out in the ordinary way to the apartments to be heated.

Having thus fully described my improved furnace, what I claim therein as new, and for which I desire to secure Letters Patent, is—

1. The arrangement and construction of the dome and heating ring surrounding the same, combined by a series of pipes opening into the base of the dome, and carrying the smoke up over the same as herein specified.

2. I also claim the construction and arrangement of the smoke pipes, so as to prevent the lodgment of dirt therein, and precipitate the same into the fire chamber, thereby preventing the clogging of said pipes.

3. I also claim the puppet valve cover, arranged and combined with the dome of the furnace, by which I insure a stopper at that point, not liable to the derangement of ordinary valves used for similar purposes.

N. A. BOYNTON.

Witnesses:

Wm. GREENOUGH,
THOM. E. WARREN.

N. A. BOYNTON.

Hot-Air Furnace.

No. 11,545.

Patented Aug. 22, 1854.

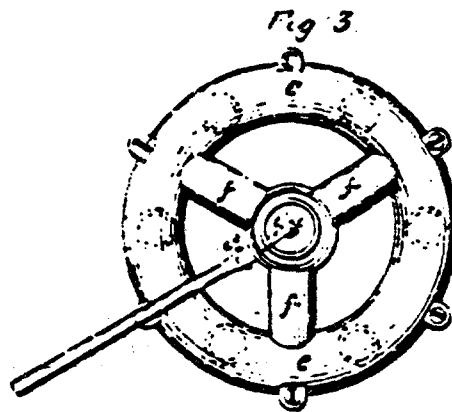

Fig 1

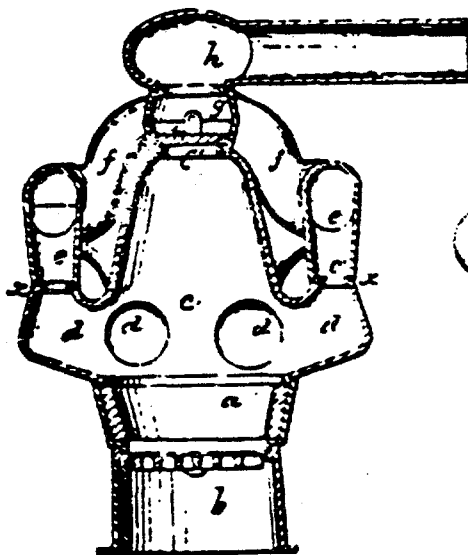
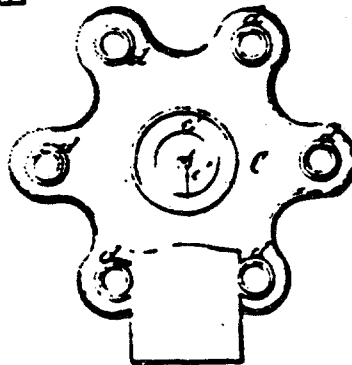

Fig 2



E. A. TUTTLE.
Hot-Air Register.

No. 10,371.

Patented Jan. 3, 1854.

Fig. 1

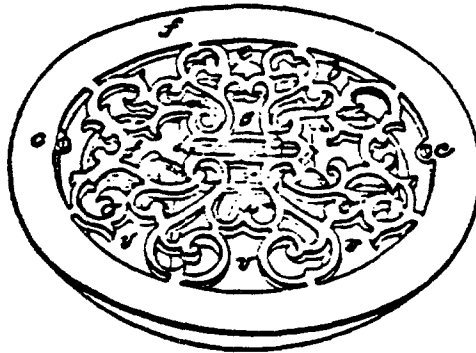

Fig. 2 Section

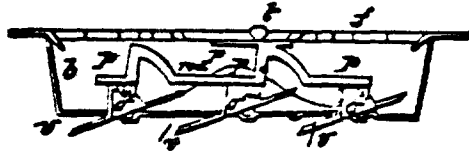

Fig. 3



Inventor
Edward A. Tuttle

UNITED STATES PATENT OFFICE.

DAVID CULVER, OF NEW YORK, N. Y.

REGISTER FOR HOT-AIR FURNACES.

Specification of Letters Patent No. 3,698, dated August 10, 1942.

To all whom it may concern:

Be it known that I, DAVID CULVER, of New York, in the county of New York and State of New York, have invented an Improved Register for Hot-Air Furnaces or for Ventilating Buildings; and I do hereby declare the following to be a full, clear, and exact description of the same, reference being had to the annexed drawings, making a part of this specification, in which—

Figure I is a perspective view. Fig. II is a plan. Fig. III is a cross-section.

Similar letters refer to similar parts in all the figures.

15 The nature of my invention consists in an improved mode of hanging and operating the leaves of the register by which they can be opened, closed, and adjusted to any required aperture.

20 In a suitable frame or box (*a*) which can be cast in iron or other metal I place the several parts for holding the leaves, and the mechanism for operating them, as follows:

Around the inside of the box and near its underside I secure a narrow rim (*b*), near the center of this rim a bar extends across the box longitudinally dividing it into two parts, next two leaves, are placed within the box of sufficient length and breadth to fill the space formed by the framing (*b*) (*c*). The leaves are suspended on pivots placed in their ends and midway from side to side so that they are perfectly balanced and thereby not liable to swing either way, from any angle they may be placed in. The holes to receive their pivots are made in the frame (*b*). A vertical shaft (*d*) is next inserted in the center of the box, the lower point resting upon the cross piece (*e*) while the

upper end is held by a bar extending across 40 the box. It is intended to inclose the box at the top by a fancy plate of fret work or castings made from a carved pattern, in which case a hole in the center to pass the shaft through super-sedes the use of the cross bar 45 before named for the upper bearing, the shaft has a lever (*e*) attached from the ends of which two connecting rods extend to the leaves at (*f*) where they are fastened in a loop placed above the center. On the top 50 of the shaft (*d*) there is a handle to operate the leaves. Thus the construction is complete. The register is then placed over the openings leading from the hot air flues, either on the floor wall or ceiling as the situ- 55 ation may require.

In operating, a very small movement is required to produce a full opening of the leaves. The leaves as hung are completely counterbalanced every way so that they re- 60 quire very little power to operate even on a large scale, where the leaves are very heavy, as in a register for churches, public buildings, &c. They will also remain at any angle they may be placed at without screws, 65 catches or fastenings of any kind.

What I claim as my invention and improvement and desire to secure by Letters Patent is—

The combination of the lever (*e*) by con- 70 necting rods with the leaves (*d*) of the register, the said lever being placed within and beneath the top of the box containing the same substantially as herein described.

DAVID CULVER.

Witnesses:

JOSEPH P. PRASON,
J. L. KINGSLEY.

D. CULVER.
Hot Air Register.

No. 5,698.

Patented Aug. 10, 1848.

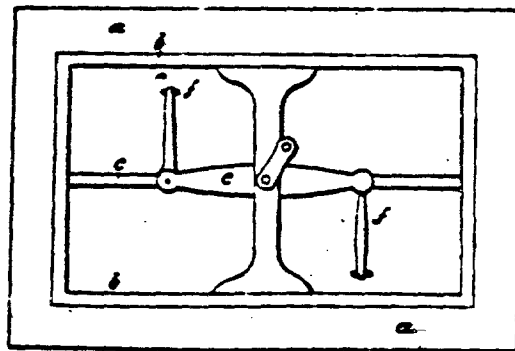
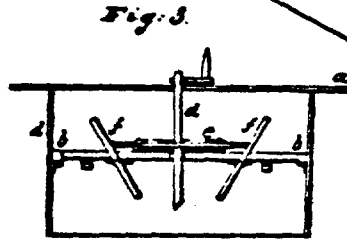
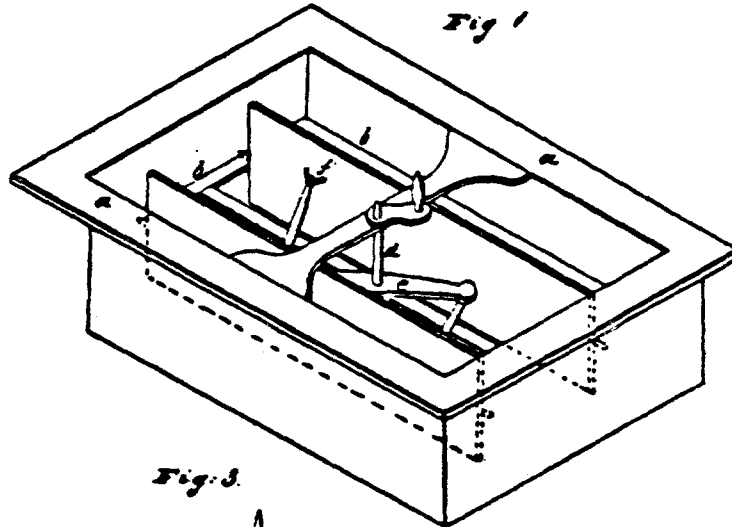

Fireplace Fresh-Air Intake System

Room 106 and 109

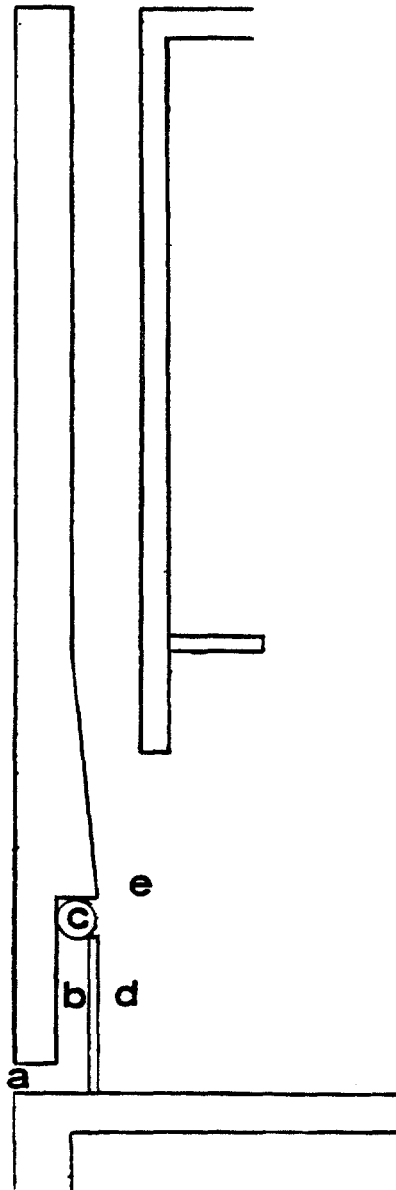

- a. Opening in exterior wall through which fresh air passes. Opening has a decorative, hinged metal cover.
- b. Chamber in which fresh air is heated.
- c. Horizontal pipe that carries heated air to vents on either side of the fireplace. These vents are covered with the same metal covers as the exterior openings.
- d. Metal plate covering fresh-air chamber.
- e. Firebox in which fire is built.

Flues of Chimney 3

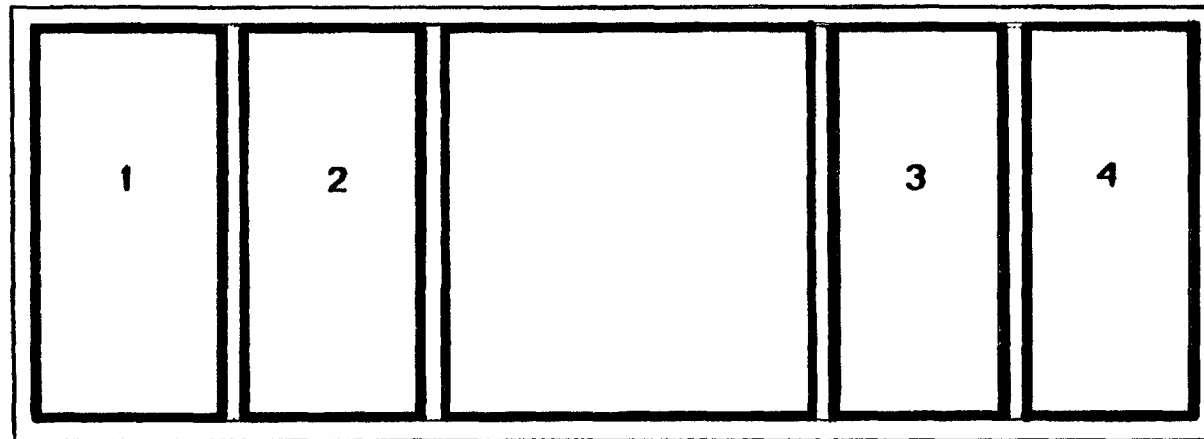

218

Flues from the fireplaces in rooms 007, 009, 112 and 114 run into flue opening 1.

Flues from the fireplaces in rooms 005, 006, 109, 111 and 210 run into flues opening 2.

Flues from the fireplaces in rooms 106 and 209 run into flue opening 3.

At present no fireplace flues run into flue opening 4.

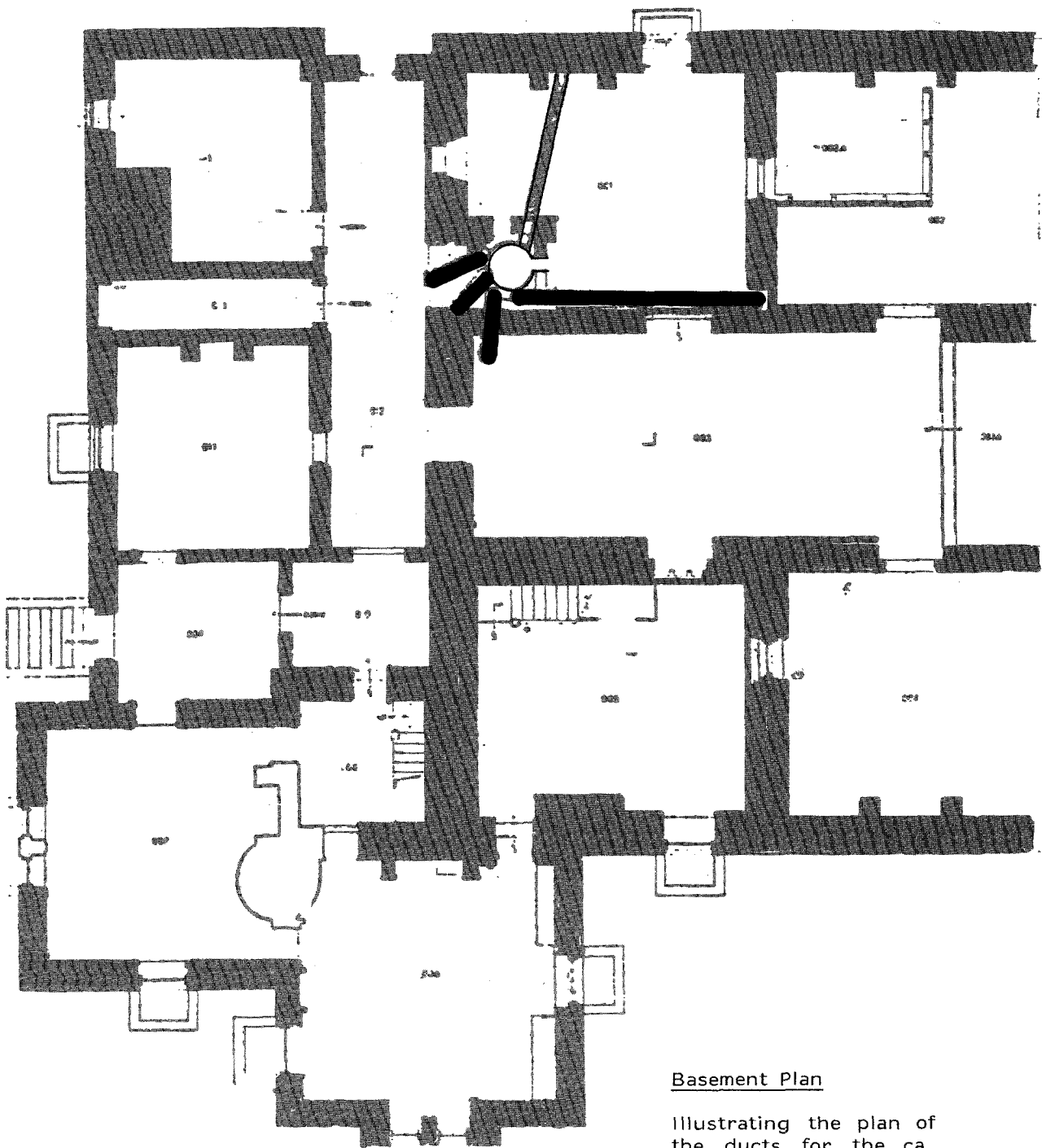

Basement Plan

Illustrating the plan of the ducts for the ca. 1854 hot-air furnace.

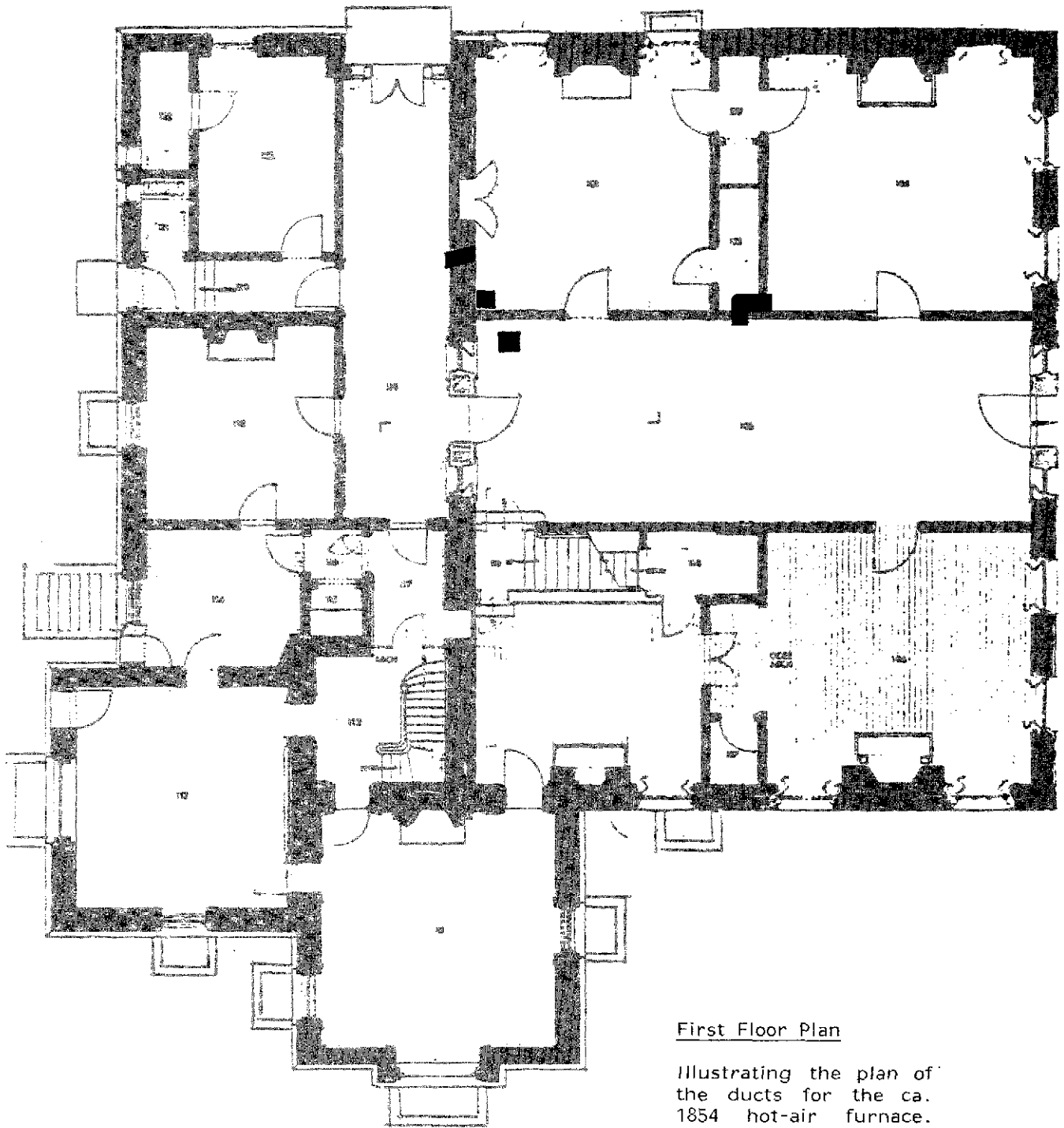

First Floor Plan

Illustrating the plan of
the ducts for the ca.
1854 hot-air furnace.

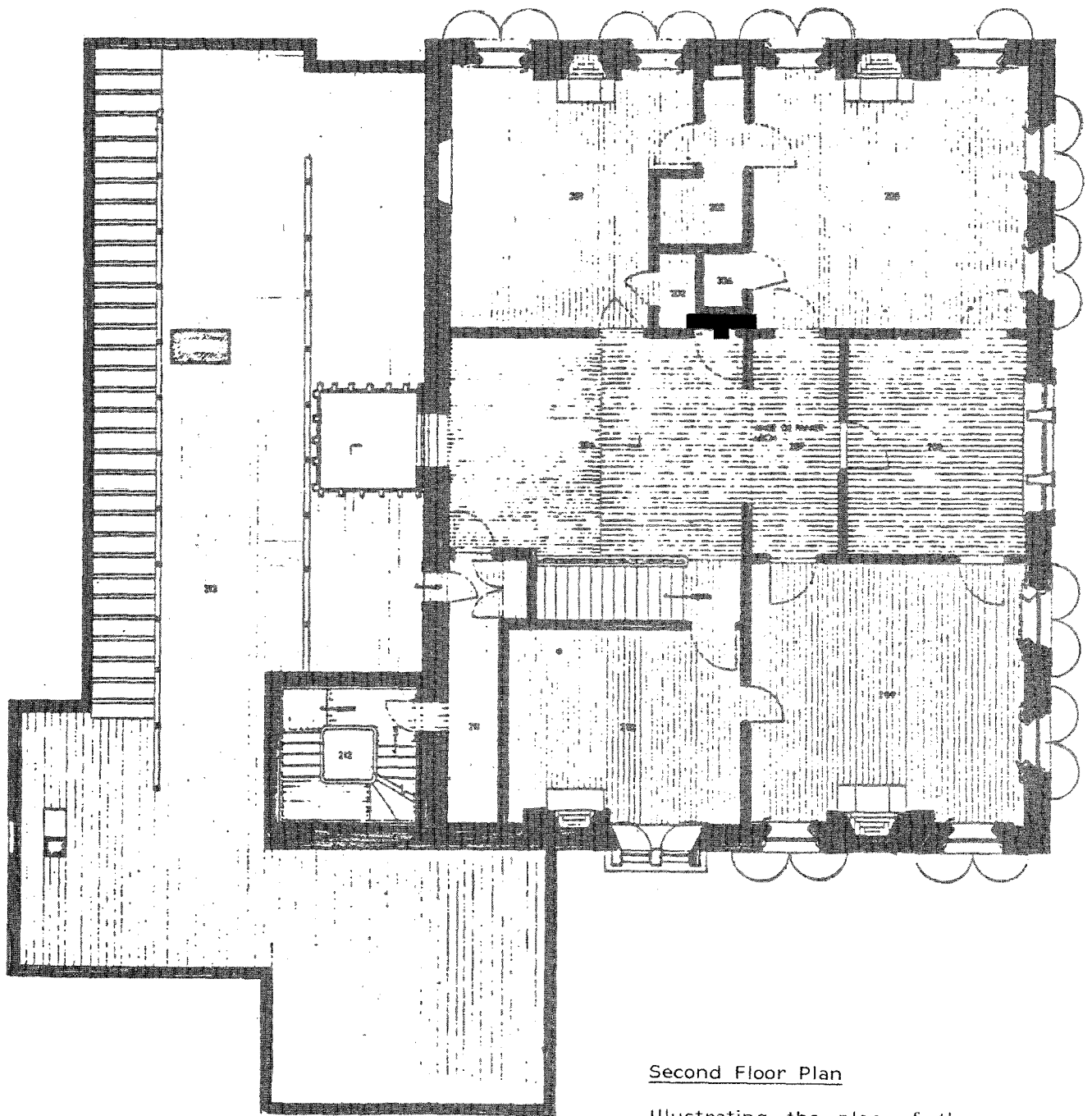

Second Floor Plan

Illustrating the plan of the ducts for the ca. 1854 hot-air furnace.

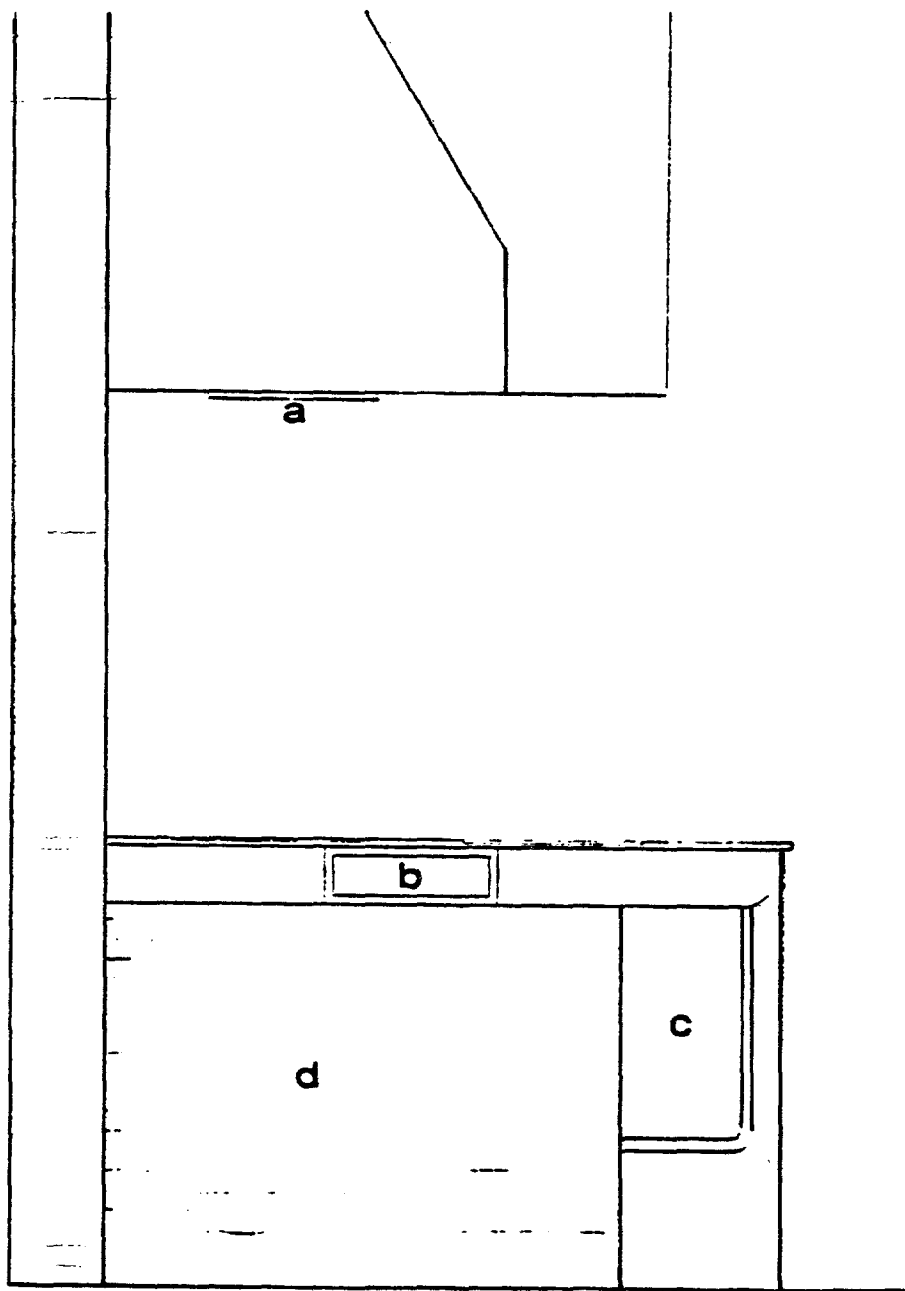

North/South Section of Cookstove

- a. Metal vent in fireplace flue
- b. Opening through which hot air passed into the chambers surrounding the ovens
- c. Fire grate
- d. Brick platform

East/West Section of Cookstove
Ovens showing the heating
chambers surrounding the ovens.

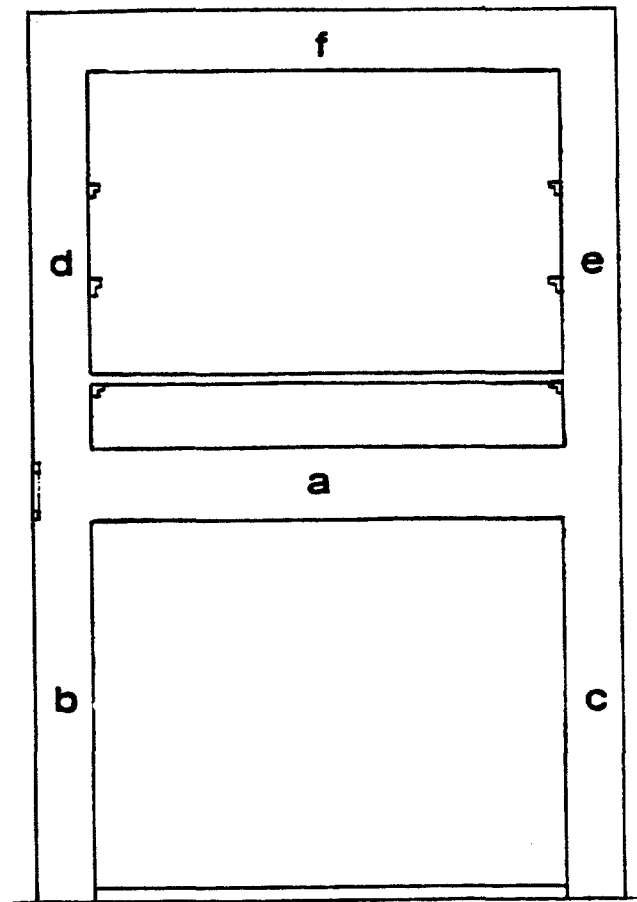

The markings found on the cook stove and physical evidence found in the kitchen suggest that the cook stove was installed between 1850 and 1855. In Boston City Directories, Moses Pond & Co. is listed at 28 Merchants Row, Boston, only until 1851, indicating that the cook stove was probably manufactured before this date. After 1851, the company moved to Blackstone Street, Boston. The cook stove was probably installed soon after it was manufactured.

United States patents for the years 1840-1875 were checked for the patent that had been applied for on the Lindenwald cook stove. Moses Pond did receive three patents for cook stoves during this period: the first on January 7, 1862 (patent 34,1200); the second on June 9, 1863 (patent 38,838); and the third on December 13, 1864 (patent 45,432). None of them, however, was for a stove like the one at Lindenwald.

Mortar samples taken from the brick of the bake oven in the northwest corner of the kitchen indicate that this oven dates to the building of the Upjohn addition. It seems unusual that such an elaborate brick oven would have been built if the kitchen already had a cast-iron cook stove with two ovens. Conversely, it seems unlikely that the fireplace would have been built with an arched opening if the builders had known that a cook stove was to be installed in it. This evidence seems to suggest that the cook stove was not installed when the kitchen was constructed in 1850, but very shortly thereafter. It may have been installed when it was discovered that smoke from the laundry room fireplace was passing through the bake oven into the kitchen, rather than up the chimney. This problem, along with smoke problems with the fireplaces in rooms 114 and 112 was discovered before the building of the Upjohn addition was completed, quite possibly before the basement rooms were finished off. A logical solution to the problem would have been to brick in the bake oven and plaster over it and to replace it with a cook stove built into the fireplace.

The cook stove appears to have been abandoned for cooking and heating when the kitchen was moved from room 006 to room 112. Evidence presented in the descriptions of rooms 006 and 112 indicate that this move was made late in the 19th century.

c. Recommendations

The objective of the proposed space conditioning system is the preservation of the structure and the artifacts that will be displayed or stored within it. Human comfort is not a major concern. The structure is not particularly sensitive to environmental conditions. The major considerations are to minimize moisture migration through the masonry walls and condensation on window panes and elsewhere. This can be accomplished by keeping indoor relative humidity and temperature low (30 to 40 percent RH; 50 to 55 degrees F). However, recommended conditions for the furnishings and artifacts are 40 to 60 percent relative humidity and temperature between 60 and 75 degrees F (15 to 24 degrees C). It is more important to avoid rapid or frequent fluctuations in temperature and humidity than to observe these limits strictly. Preservation of the historic wallpaper to be reinstalled in room 105 requires a more rigorously controlled environment. Historic variations in

temperature and humidity caused the paper to expand and contract so much that it actually caused bulges and long tears. Paper is more affected by changes in humidity than by changes in temperature. Therefore, a humidity control system is desirable for room 105. In order to provide optimal control for this sensitive space, the thermostat and humidistat should be located in room 105 above door 107 and concealed by the projection of the entablature. Normal settings for the controls and design temperature and humidity should be 55 degrees F and 40 percent relative humidity for winter conditions. For energy conservatio, it is recommended that all attic floors be insulated to achieve thermal resistance (R) value of 30. A life cycle cost analysis was conducted to determine if the present oil fuel system should be changed to LP gas. It was determined that it will be more cost-effective to continue to use oil fuel for heating.

The recommended environmental control system consists of a hot-water boiler located in room 001; an air handling unit connected reversibly to the historic furnace and including a humidifier; and individually controlled fan coil units for the areas of the house not served by the historic duct system. The fan coil units may be placed in closets where possible and in the smoke chambers of fireplaces where there are no closets. This system is estimated to cost \$41,000.

3. Plumbing

The ca. 1850 plumbing system at Lindenwald consisted of cold-water supply and drainage pipes for room 006, the kitchen; room 007, the laundry; and room 115, the water closet; and a hot- and cold-water supply and drainage pipes for room 114, the bathroom. Advanced for its time, the plumbing system installed by Van Buren is a fine example of an early and very primitive attempt to supply a home with hot and cold running water and sanitary waste disposal. Its uniqueness is its remarkable state of preservation, particularly the water closet.

The source of the water for this system appears to have been on the south side of the house, probably a well or underground cistern. The feature described as a "cist" on the south side of the building in the archeologist's report may have been associated with the water supply of the house (NPS, Fiero 1983, 64).

The system appears to have had two types of drainage. The sinks in the kitchen and laundry room drained directly to the south side of the house, possibly into a sort of dry well or the "cesspool" shown on Victor DePosse's drawing. The bathroom sink, water closet, and bathtub drained into a cesspool in room 009.

The cesspool is a circular stone-lined structure 48" in diameter and 76" deep (NPS, Fiero 1983, 65). A brick overflow drains from the top of the northwest side of the cesspool. The sides of the drain are made of bricks stood on end; the bottom is lined with brick. It is covered in some areas by metal and in others by tabular stone. It runs north across room 011 near the west wall. A depression in the floor of room 013 indicates that the drain runs across this room and into the privy in room 014. The cesspool is not vented. Its lack of ventilation

and its location within the building are clear indicators of the primitiveness of the system.*

a. Kitchen - Room 006

The sink in the kitchen appears to have been located in the southwest corner of the room. The sink is no longer in place, but physical evidence suggests that it rested on a 4" thick concrete facing that extends across the south and west walls. This facing runs for 5'7" along the south wall and 10" along the west wall (it is incomplete along the west wall). It is approximately 2' 3-1/2" high (see photograph No. 1). The sides of the sink, not supported by the concrete facing, were probably supported by a wooden cabinet.

The size or shape of the sink cannot be determined accurately from the size of this concrete facing because a lead pipe and valve projecting from the southwest corner of the faced area (see IP091) indicate that a force pump also stood in this area.** The location of the pipe and valve place the force pump at the west end of this area; the sink was positioned at the east end.*** Their exact locations, however, cannot be determined from extant physical evidence.

Water appears to have been supplied to the sink through a pipe that entered the southwest corner of the room through a square opening just above the concrete facing. This pipe was probably connected to a hand pump--very likely the W. & B. Douglas hand pump found in the laundry room. (Patent 35,802, BPL). Both the water supply pipe and the hand pump have been removed. There is no evidence to suggest that this sink had a hot-water supply.

*Books and articles about early plumbing clearly recommended that pipes be vented and trapped, and cesspools located beyond the exterior walls of the building. See Teale 1878, Brown 1884, Helleyer 1877. Helleyer writes, "No sanitary fitting inside a house should be without a trap. This trap should be close to the fitting as possible to prevent any length of waste-pipe from being untrapped on the house side of the pipe, as it is sure, sooner or later, to get corroded and become offensive" (p. 5).

**A force pump found in the laundry room screws directly onto the valve. Its location precludes the positioning of the soapstone sink found on the grounds of Lindenwald in this corner. This soapstone sink measures 4'10-1/2" long and 2' wide.

***The position of a sink and force pump in this way is described in Hussey 1976. He says, "If a pump is required to elevate water to a tank, use any first-class doubleacting force and lift pump, metal valves; set it up by sink in kitchen, or elsewhere, connect it with cistern or well, or both with a well and rainwater cock, and also with the tank, using suitable size tin-lead pipe, and leave complete with cut-off cock wherever required and arranged, so as to be able to draw water from cistern or well at will, also to discharge it at a sink, or pump it to a tank at will."

The kitchen sink drained through the opening in the concrete facing in the south wall. This drain opening is 2-1/4" in diameter and tapers to a narrower pipe that penetrates the brick wall.

b. Laundry Room

The sink in the laundry room is along its south wall, immediately to the west of window 014. The sink currently has been removed from its original location and is stored in the laundry room (see IP092). The drain pipe attached to the sink and the opening in the south wall where this drain pipe fits, however, accurately identify its location along the south wall.

The sink is composed of a rectangular lead basin built into a wood cabinet (see IP092). In the southwest corner of the lead basin is a 3" drain opening. The wood cabinet of the sink has deteriorated significantly and will require extensive rebuilding. The lead basin is in good condition.

Water was supplied to the sink by a lead pipe connected to a hand pump on the west side of the sink. This pipe and pump are no longer attached to the sink, but the pipe is still in the south wall and the hand pump is attached to it (see IP093). The pump is marked "Downes Co., No. 2, Seneca Falls, N.Y." The sink drained directly to the south side of the house, probably into a type of dry well.

There may have been other washtubs in the laundry room, but there is no physical evidence in the room to suggest that they had a direct water supply or an exterior drainage pipe.

c. Bathroom

The bathroom at Lindenwald is comprised of three rooms--114, 115, and 116. Room 114 contained the bathtub and sink, room 115 the water closet. Room 116 is a small hallway that joins rooms 114 and 115 and also opens onto the staircase hall, room 117. The layout of the rooms, records of the original drawings for the Upjohn addition, and evidence found in the paint samples indicate that the bathroom was built, and its water closet, sink, and bathtub installed, ca. 1850.

The water supply for the bathroom appears to have been on the south side of the house. Water was pumped up into a storage tank in room 115 by a force pump in room 006, the kitchen. A force pump that fits onto the valve in room 006 was found in room 007, the laundry. It is mounted on a piece of wood 4' 6" long by 9-3/4" wide (see IP023). The top of the piece of wood is rounded, and it is grained. This force pump bears the markings "W. & D. Douglas, Middletown, Connecticut," and the patent date of July 1, 1862. This patent was for a new type of bracket for attaching "side force pumps" to their wooden supports (Patent 35,802, BPL). The date of July 1, 1862, indicates that this was not the force pump that was originally used to pump water into the water closet tank, since all the other evidence found thus far indicates that the water closet was installed ca. 1850. However, it is an early force pump and the original one was probably similar to it.

A pipe from the force pump appears to have run along west walls of room 006, the kitchen, and room 008, the stair hall, into room 010, the hall. Once inside room 010, the pipe turned and ran vertically up into the water tank in room 115. Evidence for the route of this pipe includes an opening in the wall, at ceiling height, between rooms 006 and 008, remnants of a wood pipe chase along the west wall of room 008; and an opening, again at ceiling height, between rooms 008 and 010. In this latter opening are three lead pipes that run up to the water tank in room 115. One of these pipes, the one that terminates in an arc in the water tank was the supply pipe.

The water storage tank in room 115 is made of wood and is lead-lined. It measures 3' 11-1/2" long, 2' deep, 2' wide (a volume of 90 gallons or more) and has a hinged wooden cover (see IP094). Supply pipes from this tank run to the water closet, the sink, and the bathtub. In addition, there are two other pipes in the water tank. One, on the east side of the tank, is a vent for the water supply pipe to the water closet (see IP095). The other, on the west side of the tank, is an overflow pipe that runs into the basement, probably to the sink in room 006, the kitchen (see IP094).

The three primary pieces of toilet furniture in the Lindenwald bathroom were a water closet, lavatory, and bathtub.

(1) Water Closet

The water closet, located in room 115, is a "pan type" closet. This type of water closet is distinguished from other early water closets by a shallow copper pan that covers the waste opening of the earthenware bowl (Brown 1884, 61). The basic components of the water closet are its bowl, waste receptacle, soil pipe, and flushing mechanism. They are enclosed in a wooden case (see IP097 and 098). It is similar to the water closet advertised by Thomas Thirkill of Bristol in 1858, which is illustrated in Mark Girourard's 1978 book, Life in the English Country House.

The bowl of the water closet is white with a transfer-printed blue floral pattern (see IP098). It is marked "Wedgwood," "Pearl," and "1385." "Pearl" refers to the type of porcelain from which the bowl was made: a hard white earthenware made by mixing lighter clays with ordinary whiteware clays. It was first made about 1780 (Savage and Newman 1975, 216). The number "1385" refers to the shape of the bowl. A bowl bearing this number is found in the Wedgwood Shape Book of 1803 and in the ca. 1810, Traveler's Notebook.* In the Traveler's Notebook, its dimensions are given as 14-1/2" wide, 17" long, and 9" deep. The measurements of the Lindenwald bowl are 14-1/2" wide, 16-3/4" long, and 8-1/2" deep, which are sufficiently close to

*Both of these books are now in the Wedgwood Museum, Barlaston, Stoke-on-Trent, England.

indicate that it is the same bowl.* No documentation could be found to identify the floral pattern on the bowl.** The bowl sits on the cast-iron waste receptacle, into which the copper pan tips. This receptacle measures 13-1/2" in diameter at its top and tapers to join a 3" soil pipe at its bottom.

The soil pipe runs down into room 010, where it turns at ceiling height and runs in a westerly direction to the southwest corner of the room. There it turns and runs vertically down into a hole in the floor and into the cesspool in Room 009. Evidence for the route of the soil pipe includes remnants of a pipe casing in the southwest corner of room 010, and a 3" hole in the corner of that room that connects with a 3" lead soil pipe that runs into the cesspool.

The flushing mechanism for the water closet consists of a circular knob, set in a dish-shaped metal frame. The knob is attached to a metal shaft, which in turn is connected, at roughly a 90 degree angle, to a second shaft that tips the hinged copper pan. This second shaft is also connected to a wire attached to the lead weight and valve in the water tank that control the water supply for the water closet (see IP096). When flushed, the copper pan tips, emptying the wastes into the cast-iron receptacle; the wire running up to the water tank tightens, lifting the lead weight. This opens a valve in the bottom of the water supply tank and allows water to run down into the water closet bowl. Pan closets were designed so that there was a slight differential between the time it took for the pan to tip and the water to run into the bowl. The water from the supply tank was to reach the bowl after the pan had been tipped, so that when in an upright position, the pan contained 3" or 4" of water. This water sealed the bowl and prevented sewer gases from the soil pipes below from entering the bowl (Brown 1884, 28). Whether or not the Lindenwald water closet functioned with such a time differential cannot be determined since it is not operational.

With the exception of segments of the water supply pipe and the soil pipe in the basement, the 1850 water closet at Lindenwald is intact.

*Slight variations in the size of the bowl can be accounted for by variations in the temperature at which the bowls were fired. See the letter of January 24, 1980, from Sharon Ratcliffe, Museum Assistant, Wedgwood Museum, at the end of this chapter.

**Photographs of the bowl were sent to the Wedgwood Museum, Barlaston, Stoke-on-Trent, England. No positive identification could be made. See the letter from Sharon Ratcliffe.

(2) Bathtub

The bathtub at Lindenwald was located in the northwest corner of room 114.* It is no longer in its original location but is in storage at the site (see IP099). It will be returned to its original location when the bathroom is restored.

The bathtub is composed of a copper tub built into a wood frame. The tub is tapered, with a curved back. It is made of five pieces of metal soldered together. It is 2' wide at the front and 2'4" wide at the back. It is 5'10" long and 1'11" deep. It has a drain in the bottom of its narrower end and an overflow drain on the left side of this same end (see photograph 6). The wood frame is made of rough pine boards. Nail holes in the top of this wooden frame indicate that originally it was covered with a wooden case. Other documentation for this case is found in Richard Upjohn's planbook in an entry dated January 7, 1850, which states: "To Martin Van Buren - Plan for Bath Case to be 1 in. scale and details full size."

This entry is noteworthy for two reasons. First, it clearly indicates that the bathroom was installed when the Upjohn addition was built. And second, it is the only entry in Upjohn's planbook for a drawing being sent specifically to Martin Van Buren. All of the other drawings for the Lindenwald addition were recorded as being sent to Smith Thompson Van Buren.

In addition to the bathtub, two bath or sink cocks, reputed to have come from the Lindenwald bathroom, have been found.** One bears the markings "J.S. Payne Co., New York," and the other "J. & H. Jones, New York." They are of similar design, but not identical.

*The most obvious reason for locating the bathtub in the northwest corner of the room is that the north wall is the only wall that is long enough to position a bathtub. The placement of the doors and windows in the other walls precludes the bathtub being along them. Other evidence supporting this location includes

paint analysis (paint samples from the plaster walls that would have been behind the bathtub casing contain approximately three fewer layers than paint samples from other wall surfaces)

replacement of floorboards under the area where the bathtub stood

missing subflooring in the area where the front of the bathtub and its drain would have been

remnants of a wooden pipe casing, lead straps, and hangers in room 009, directly below where the bathtub would have been located

**A Kinderhook man, whose father had been a plumber, gave the brass cocks to the National Park Service in 1974. He said that his father "had removed them from Lindenwald."

Research in New York directories indicates that J.S. Payne started business in 1845. In that year he is listed at 101 Elm Street in Dogget's New York Directory. In the 1851-52 Dogget's New York Directory, the business first appears as Joseph S. Payne and Co., brass cock manufacturer, at 12 Canal Street. This listing continues through 1860, the date of the last directory researched. J. & H. Jones, brass cock manufacturers, 38 White Street, first appear in New York directories in 1844 and they are still listed in 1860.*

These directory listings confirm that the cocks are of the correct date to have been used in the bathroom at Lindenwald. However, the listings, other historical documentation, and physical evidence derived from the bathroom do not positively identify them as the brass cocks used in the original bathroom at Lindenwald.

Examination of the walls surrounding the bathtub and paint analysis provided additional information about the wooden case that surrounded the bathtub. Raking light was used to locate any markings on the wall that could be associated with the bathtub. On the north wall a horizontal line, at a height of roughly 2' 9" from the floor, is visible. Paint samples taken below this line contained three fewer layers of paint than those above this line (see P612 and 613). It seems likely that this line represents the height of the bathtub casing.

As noted above, the height of the bathtub in its rough wooden frame is 1'11" and the height of this horizontal line on the north wall is 2' 6-1/2". This 7-1/2" difference suggests that the bathtub may have stood on some sort of platform, a common practice for these early wooden encased tubs. A metal pan was often placed under the bathtub to protect the wooden floor beneath.** It may indicate also that the bathtub had a splash board.

Examination of the north and west walls in the area where the bathtub would have been located also revealed that the bathtub had been surrounded by some sort of frame. Evidence for this frame includes paint lines on the plaster walls and differences in the number of paint layers found in samples taken from within and outside these lines. Samples from within the lines contain three fewer layers than those from outside the lines.

The posts for the frame are approximately 5" wide and run from a height of 9' down to the horizontal line that marks the height of the casings. The equidistant lines in the northwest corner of the room indicate that the posts were probably square. On the west wall, the outer edge of the post is located 2' 7-1/2" from the northwest

*New York directories were checked for the years 1835-60. The directories are on microfilm at the Boston Public Library. They include Longworth's, Dogget's, Rodes's, and Trow's directories.

**Illustrations in the magazine The Builder (March 5, 1853, and July 16, 1853, issues) and in Wright (1960, 220) show the use of such pans. The first two are included at the end of this section).

corner, on the north wall it is located 6' 1-3/4" from this corner. These lengths coincide roughly with the size of the wooden bathtub casing. A fourth post probably stood at the southeast corner of the bathtub.

Besides these vertical posts, areas of paint build-up and paint analysis revealed a horizontal band that extended around the area demarcated by the posts. This band is roughly 30" wide and extends from the top of the posts up to a height of 11' from the floor.

The posts and horizontal band strongly suggest that the bathtub was surrounded by a wooden frame and draperies (Stone 1979, 14:287*). The post at the northeast corner of the bathtub also appears to have served as a pipe casing for the cold water supply to the bathtub. The horizontal band, probably of wood, may have been decorative only, or it may have been associated with a shower. Extant evidence provides no positive identification for its function.

Cold water was supplied to the bathtub from the tank above the water closet in room 115. A small segment of the bathtub supply pipe projects from the lower righthand corner of the front of the tank. This pipe ran along the west wall of room 115 and through a circular hole in the wall into room 116. At the north wall of room 116 the pipe turned at roughly a 90 degree angle and ran into room 114. An opening in the plaster wall between rooms 114 and 116 reveals that the beam has been carved out to allow the pipe to pass through this area. Once in room 114, the pipe appears to have run west, horizontally to the first wooden post, where it turned and ran vertically down to the bathtub.

The source of hot water for the bathtub and the sink is less clear than the cold water supply. It seems likely that there was some sort of system for supplying hot water to the bathroom at Lindenwald (NPS, Weig 1936, 48). Mrs. DeProse, in her Inventory of Martin Van Buren Furniture at "Lindenwald," lists "Van Buren's copper hot water boiler" (name painted on side), further indicating that Lindenwald had a hot-water supply. No evidence of this copper boiler has been found. Descriptions of bathrooms ca. 1850 state that they should be supplied with hot and cold water.** Physical evidence suggests two possible means by which the bathroom could have been supplied with hot water.

One source of hot water may have been a boiler in basement room 009. In the southeast corner of this room is a brick platform that measures 2'5" by 2'8". This platform was level with the room's original floor (see IP100). In the south wall, directly above this platform, is a 6" flue opening. Since this room was used only as a

*Advertisement from plumber Charles Hillsburgh, New York City, 1840-45, shows an elegant bathtub surrounded by draperies.

**See the illustrations from The Builder at the end of this section.

service entrance, it seems unlikely that it would have had its own stove in this location. It is a logical location for a hot-water boiler.

A hole in the floor of room 114, above the brick platform and not associated with the sink's cold water supply or drainage, further supports the contention of a boiler in room 009. This hole could have been for the hot water supply to the sink. The hot-water supply pipe for the bathtub could have run across room 009 and up through the floorboard that is missing in the area of the front of the tub. Water could have been supplied to this boiler from a carrier pipe running off the sink or the bathtub cold-water supply pipes.

An alternative source of hot water may have been a boiler built into the fireplace in the southeast corner of room 114. The unusual configuration of the firebox of this fireplace suggests that it was used for another purpose than just heating the room. The fireplace in the bathroom has an arched opening. The shape of the firebox, however, does not conform to this curved shape. On its left side is a line of firebrick nearly the depth of the firebox that narrows the firebox and gives it a straight, instead of a curved, left side. In addition, the floor of the firebox is 6" below the level of the hearth.

There is no evidence of pipes that would have run to a boiler in the fireplace. Therefore, the suggestion of this odd configuration being related to a source of hot water remains highly speculative.

The bathtub appears to have drained through an opening in the floorboards in room 114 and into room 009. In room 009, at ceiling height, are remnants of a wooden pipe casing, lead straps, and pipe hangers (see IP101). In the northeast corner of the room is a wooden board placed vertically, another remnant of a pipe casing. The drain pipe from the bathtub ran in an easterly direction from the point that it entered room 009 to the northeast corner of the room, where it turned and ran vertically down and into the cesspool in the center of this room. There is also an opening in the west wall of room 114, just above the floor, which still contains a section of lead pipe. This may have been the overflow drain pipe, but it seems more likely that an overflow drain would connect to the main drain.

(3) Sink

Of the three pieces of bath furniture at Lindenwald, evidence for the bathroom sink is most scant. The sink has been removed from room 114 and, with the possible exception of a marble top found in the basement, has completely disappeared from the site. The marble sink top measures 2'6" by 1'9". Its corners are rounded and in its center is a circular opening 1' 1/4" in diameter. The edges of the circular opening are beveled. In the center of the back of the marble slab is a 1" square opening. The circular shape of the hole indicates that it is a top from an early sink. It would also have fit on the size sink that appears to have been in the room (see physical evidence described below). However, no evidence more conclusive than this has been found to establish that it was part of the original sink.

Physical evidence found in room 114 and in the basement indicates that the sink stood against the east wall of room 114 between the door leading into room 116 and the fireplace. On the floor in front of this wall is a black line that appears to outline the shape of the sink cabinet. The line is about 1-1/2" wide and outlines an area 2'3" long and 1' 7-1/2" wide. The corners of the outline are rounded.

Paint lines on the baseboard directly above the outline on the floor indicate that the cabinet stood directly against the wall. Examination of the plaster wall within the outline of the sink cabinet revealed that it has been patched extensively. Some of the patching appeared to be quite early; other areas had only a very thin coat of plaster, covered by only two coats of paint. The thin coat of plaster was removed with a scalpel, revealing an earlier patch that appears to follow the outline of the original sink cabinet and splashboard. Paint samples taken from the area that would have been inside the sink cabinet do not contain the early layers of paint found elsewhere in the room.

Cold water was supplied to the sink from the tank above the water closet in room 115. The supply pipe, still in place, runs from the bottom of the right side of the tank down the southwest corner of room 115 into the water closet case, where it turns and runs up into the east wall of room 114. A plaster patch in this wall was removed to reveal exactly where the pipe entered the room. As noted above, the source of hot water for the sink remains speculative.

The sink drained through a hole, cut at roughly a 40 degree angle, where the floor and baseboard join. This pipe appears to have run in nearly a horizontal line over to join the water closet waste pipe where it turns, directly below its waste receptacle. Evidence for the pipe running in this direction is the gouging out of the beam so a pipe could turn and join the water closet soil pipe at this point. A small segment of pipe still projects from the point where this pipe joined the soil pipe.

At first glance it appears odd that the sink drain pipe ran so far before it joined the water closet soil pipe. It could have been joined at the point where it turned and ran vertically down the corner of room 010, reducing the distance to the soil pipe by half. One possible explanation for it being set up this way is that it could have been used to help wash the wastes from the water closet down the soil pipe and into the cesspool.

d. Conclusion

The ca. 1850 plumbing system for Lindenwald appears to have been abandoned during the later years of the 19th century. The exact date of abandonment has not been determined, but evidence found in paint and wallpaper samples, as well as structural alterations, indicates that it was ca. 1890. At this time the kitchen was moved from room 006 to room 112. The bathroom was abandoned, bathtub and sink removed, and water closet converted to a closet with shelves. The relatively early abandonment of this plumbing system, particularly of the water closet, partially accounts for its remarkable state of preservation.



The Wedgwood Museum

Barlaston, Stoke-on-Trent, England, ST12 9ES

Telephone: Barlaston (078 139) 4141

Telegrams: Wedgwood Stoke-on-Trent

Telex: 36170

/SR.

10th December 1979.

Ms. A.M. Gilmore,
Architectural Conservator,
National Park Service,
Historic Preservation Center,
Bldg. 28,
Charlestown Navy Yard,
Boston, MA 02129,
U.S.A.

Dear Ms. Gilmore,

Thankyou for your enquiry dated November 19th, which has been passed on to us by the Victoria and Albert Museum, London.

The marking, 1385, which appears on the bowl of the W.C. to which you refer, indicates the particular shape of this item, which was apparently first introduced circa 1803 although this shape would have been manufactured for some years after its initial introduction. For your further perusal, I am enclosing photostat copies taken from a traveller's notebook circa 1810, and the Wedgwood shape book of 1803. You will find the bowl to which you refer illustrated in both cases.

I hope this information is of some interest and assistance to you. Should you require any further details, please do not hesitate to contact me again.

Yours sincerely,

Sharon Ratcliffe

Sharon Ratcliffe (Miss)
Museum Assistant.

Closest Pans

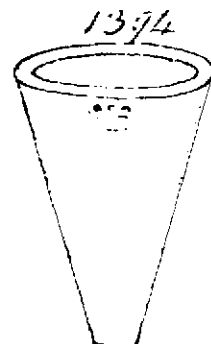
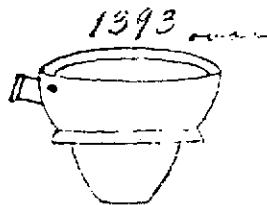
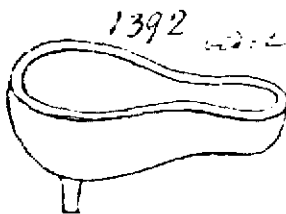
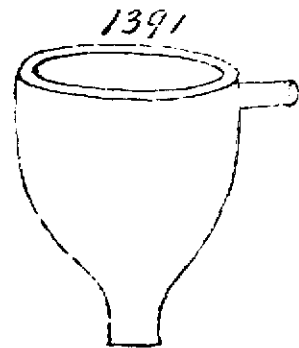
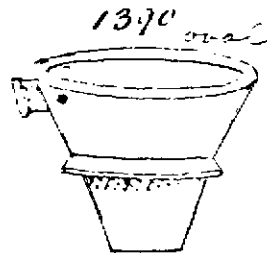
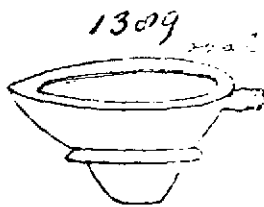
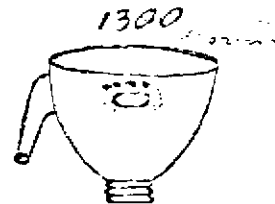
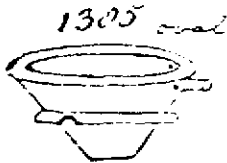
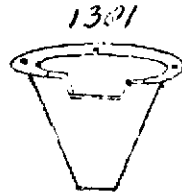
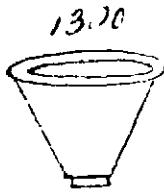
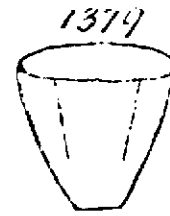
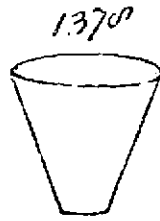
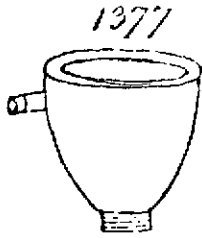

Travellers note book.

(Closest plans)

1374

1377

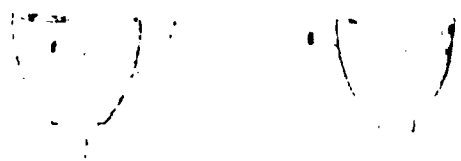

1380 in. Diameter 4 1/2. En. depth 1.

1386

1387



1388

1390

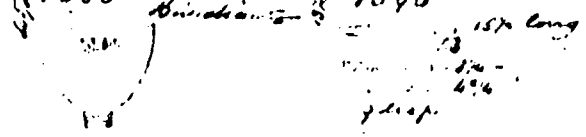

No	Inches	Plains	Remarks
1374	1 1/2	1 1/2	
1377	1 1/2	1 1/2	
1386	1 1/2	1 1/2	found 24 in. dia.
1388	1 1/2	1 1/2	found 24 in. dia.
1393	1 1/2	1 1/2	
1390	1 1/2	1 1/2	

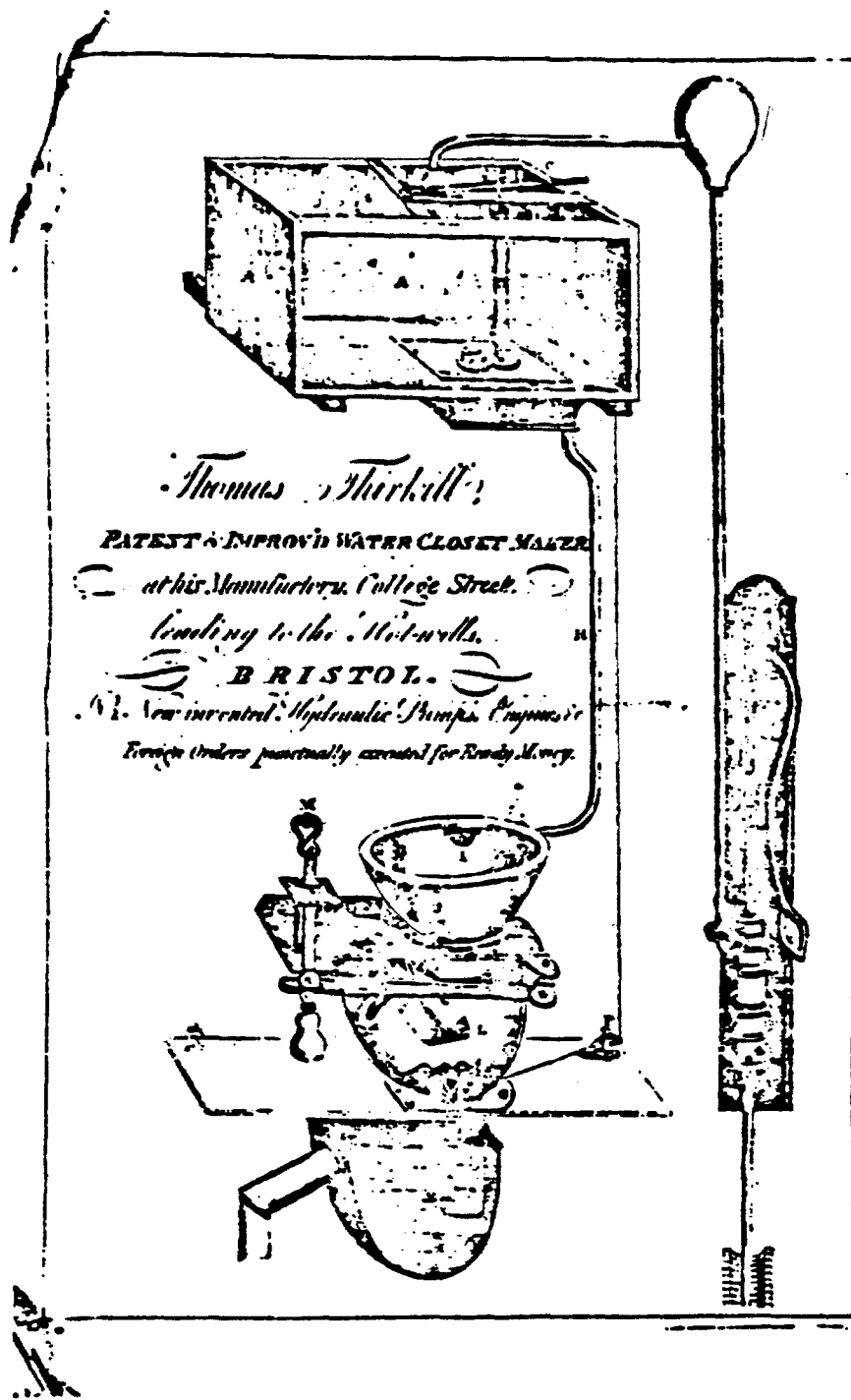

9 Second Interlude:
 Early Country-House Technology

J. TYLOR AND SON'S BATH APPARATUS.

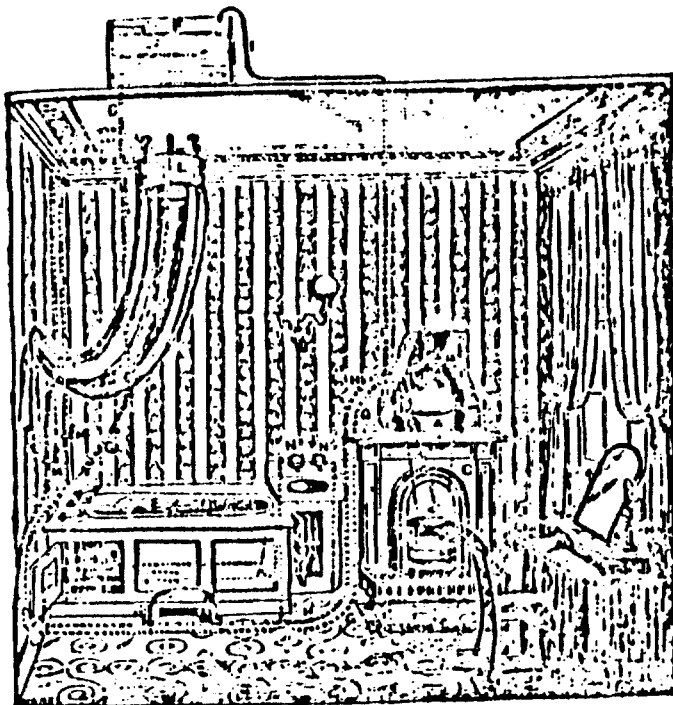

To fit a Bath, the apparatus for heating which can be fixed in the same room, and the luxury of an Open Fire retained.

A. Copper Boiler of sufficient capacity to make a warm bath, clasped by an iron band to support it, and fixed in the breast-work of a chimney. A flue is carried all round, and the draught is regulated by a revolving damper, **B**, which covers the opening into chimney. When set, the Boiler is entirely concealed from view. This Boiler can be adapted for any chimney, by making it of an oval or elongated form.

B. A soot-door to fixed just underneath the damper for the convenience of cleaning, which, however, is rarely required, on account of the great draught round the boiler preventing any deposit of soot.

C. An ordinary stove front with sliding blower for the additional regulation of the draft.

D. Copper or tinned iron Bath, enamelled white marble inside, having three copper pipes, for the hot, cold, and waste water, which are indicated by the engraved levers on the cocks. The overflow is carried into waste-pipe **E**.

F. Cistern for cold water, any 100 gallons, which can be made of tinned iron, or any suitable material, either fitted into a recess or made of a cylindrical shape to stand on the floor of any room above the bath. The overflow can be carried into the waste or other convenient outlet.

G. Inch pipe from cistern to the pipe which goes to the bottom of boiler to fill it with water. A branch from this pipe also supplies the bath with cold water.

H. Inch pipe from the top pipe of boiler, to deliver the hot water into bath.

I. Half-inch pipe taken from the hot pipe **H**, and turned over the top of cistern, to relieve the boiler.

K. Inch or 1½-inch pipe to take away waste water from bath into soil-pipe or drain, so may be most convenient, and must be well trapped before entering.

L. Round copper or tinned iron Shower Bath, suspended from ceiling, and filled with hot or cold water by branches from the pipes **G** and **H**, the supply being regulated by the two cocks **M M**, which are set in the wall, and have levers fixed on them, engraved, "hot and cold shower."

A thermometer can be fixed in the shower-bath to regulate the temperature.

N N. Wash hand basin supplied with hot and cold water, by branches from the pipes **G** and **H**, the waste being carried into the overflow of bath.

By this simple arrangement, the boiler is always kept full of water, and cannot, by any means, be emptied by the action of the fire. The draught is or regulated by the blower and damper, that a bath can be made in twenty minutes, or an open fire kept continuously alight.

J. TYLOR AND SON'S BATH APPL

To lead a Supply of Water for a Bath from an open Fire in an Apartment, either below or on the same level as the Bath.



A. Copper Saddle Boiler.

B.B. Stove Front, which covers the face of Boiler, and entirely conceals it.

In order to set the Boiler to the greatest advantage, a 4-inch Flue, if carried over it and stopped off along the middle of both sides (see fig. 1) 6 inches from the front. The Fire will pass from the back, along the side up the chimney at the back (see fig. 2). Nearly the whole of the boiler is the action of the fire.

For the convenience of cleaning the Flues, the Stove Front being screws taken down.

C. Cistern for Hot Water, having a small Feed Cistern **E**, supplied from

This Cistern can be made of Tinned Iron or any suitable material: closet as shown in engraving, or in any convenient position.

The overflow can be carried into waste of Bath, or any convenient outlet.

F. Copper or Tinned Iron Bath, having three Pipes for Hot, Cold, indicated by the engraved levers on the cocks. The overflow is carried

G. Inch Pipe from top Pipe of Boiler, and standing up 6 inches above. A branch from this Pipe supplies the Bath with Hot water.

H. Inch Pipe from side of Boiler to bottom of Hot Cistern.

These Pipes **G** and **H** should be cased in and well packed with sawdust being given off to the atmosphere.

I. Inch Pipe to supply Cold Water to Bath.

K. Inch Pipe to carry Waste Water from Bath into Soil Pipe, or ground and must be well trapped before entering a drain.

For particulars of Shower Baths, and estimates for fixing ditto, see our Illustrated Catalogue showing every method of fixing Warm Baths, to

J. TYLOR and SONS, Warwick-lane, Newgate.

B. Douglas
Pump Cylinder.

Patented July 1, 1862.

1862

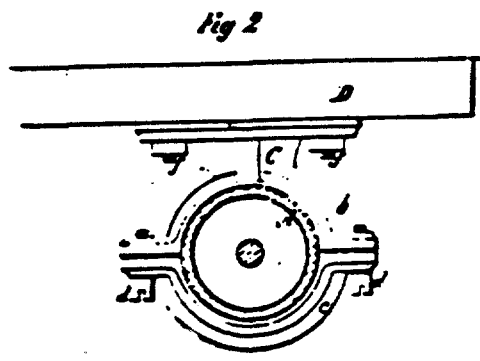
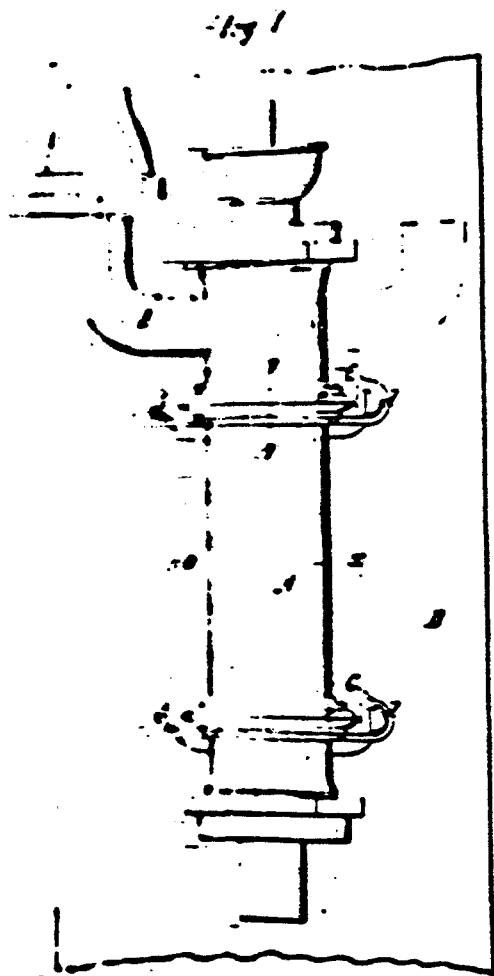

Fig 1
1862

1862
1862
1862

UNITED STATES PATENT OFFICE.

BENJAMIN DOUGLAS, OF MIDDLETOWN, CONNECTICUT, ASSIGNOR TO W.
AND B. DOUGLAS, OF SAME PLACE.

IMPROVEMENT IN PUMPS.

Specification forming part of Letters Patent No. 23,402, dated July 1, 1857.

To all whom it may concern:

Be it known that I, BENJAMIN DOUGLAS, of Middletown, in the county of Middlesex and State of Connecticut, have invented a new and useful Improvement in Pumps; and I do hereby declare that the following is a full, clear, and exact description of the same, reference being had to the accompanying drawings, making a part of this specification, in which—

Figure 1 is an elevation of my invention; Fig. 2, a horizontal section of the same, taken in the line *x x*, Fig. 1; Fig. 3, a vertical section of a portion of the same, taken in the line *y y*, Fig. 1.

Similar letters of reference indicate corresponding parts in the several figures.

This invention relates to an improvement in the hanging or attaching of what are generally known as "side force-pumps" to the plank which holds or retains them in proper working position. Pumps of this class have hitherto had their cylinders cast with fixed brackets by which they are attached to the plank, and consequently when attached to the plank the eduction-nozzle has only one position relatively with the cylinder and brackets—that is to say, the former cannot be changed to either side of the latter nor to its front—and hence it is necessary to have different patterns made with the nozzle placed in different positions—one at the right side of the cylinder, another at the left, and another projecting from its front side—in order that cylinders may be cast with nozzles at different points to suit the desired position of the eduction pipe.

The object of this invention is to obtain a pump of the class specified which will admit of being so adjusted as to bring the eduction-nozzle at any desired point; and to this end I cast the brackets separately, and with a groove or recess in their rings or bands which encompasses the cylinder, and have the latter cast with circumferential beads or projections to fit in the grooves in the brackets, the latter being composed of two parts connected by bolts, and all arranged as hereinafter fully shown and described, whereby the cylinder may be turned in its brackets and the desired result obtained.

To enable those skilled in the art to fully understand and construct my invention, I will proceed to describe it.

A represents the cylinder of a pump, and B the eduction nozzle, the latter being cast with the cylinder, as usual. On the pump cylinder there are cast two beads, *a a*, circumferentially, one being near the top and the other near the lower end of the cylinder.

C C are the brackets, which are cast separately and with rings or bands formed of two parts, *b c*, connected together by screw-bolts *d d*. The rings or bands have a recess, *e*, in their inner sides, which receive the beads *a* of the cylinder A, as shown clearly in Fig. 2. By this arrangement the pump-cylinder is retained in the brackets, and may be prevented from turning therein by screwing up the bolts *d d*, so that the two parts of the rings or bands will clasp snugly the cylinder A. The brackets C C are secured to the plank D by bolts *f* in the usual way.

It will be seen, therefore, that by loosening the bolts *d d* the cylinder may be turned so as to bring the nozzle B in any desired position, either to the right or left hand side of the cylinder, or in front of it, as may be desired.

In Fig. 1 the different positions of the nozzle B are indicated in red outline.

This invention not only admits of the shifting of the position of the nozzle, but also admits of a brass cylinder being used with iron brackets, as the latter are cast separately from the cylinder. The ordinary pumps of this kind require to have the brackets of the same material as the cylinder, as they are all cast in one piece, and hence in brass pumps a considerable saving is effected, as the brackets, when of brass, form a considerable item in the expense of construction, in consequence of brass being so much more expensive than iron.

Having thus described my invention, what I claim as new, and desire to secure by Letters Patent, is—

The securing of the pump cylinder A to its plank D by means of brackets C C, formed of two parts, *b c*, connected together by bolts *d*, and fitted on the cylinder, substantially as and for the purpose herein set forth.

BENJN. DOUGLAS

Witnesses.

JOHN M. DOUGLAS,
GEORGE M. SMITH.

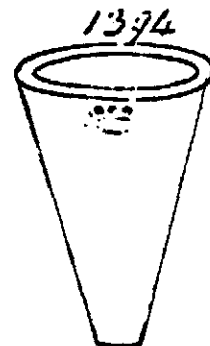
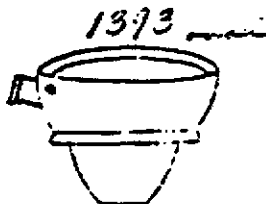
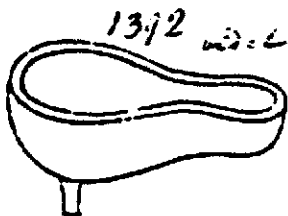
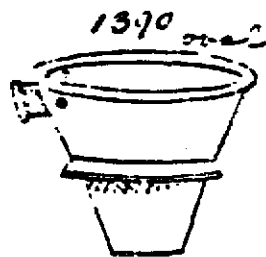
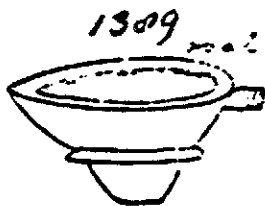
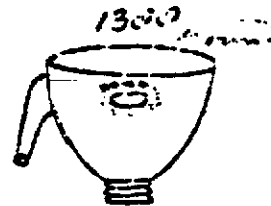
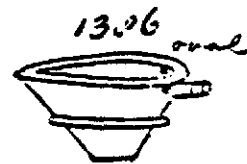
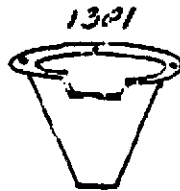
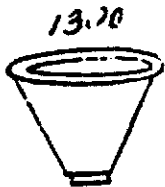

CROTON WATER. C. HILLSBURGH.

PRACTICAL PLUMBER.

N. 342 WATER

STREET, N.Y.

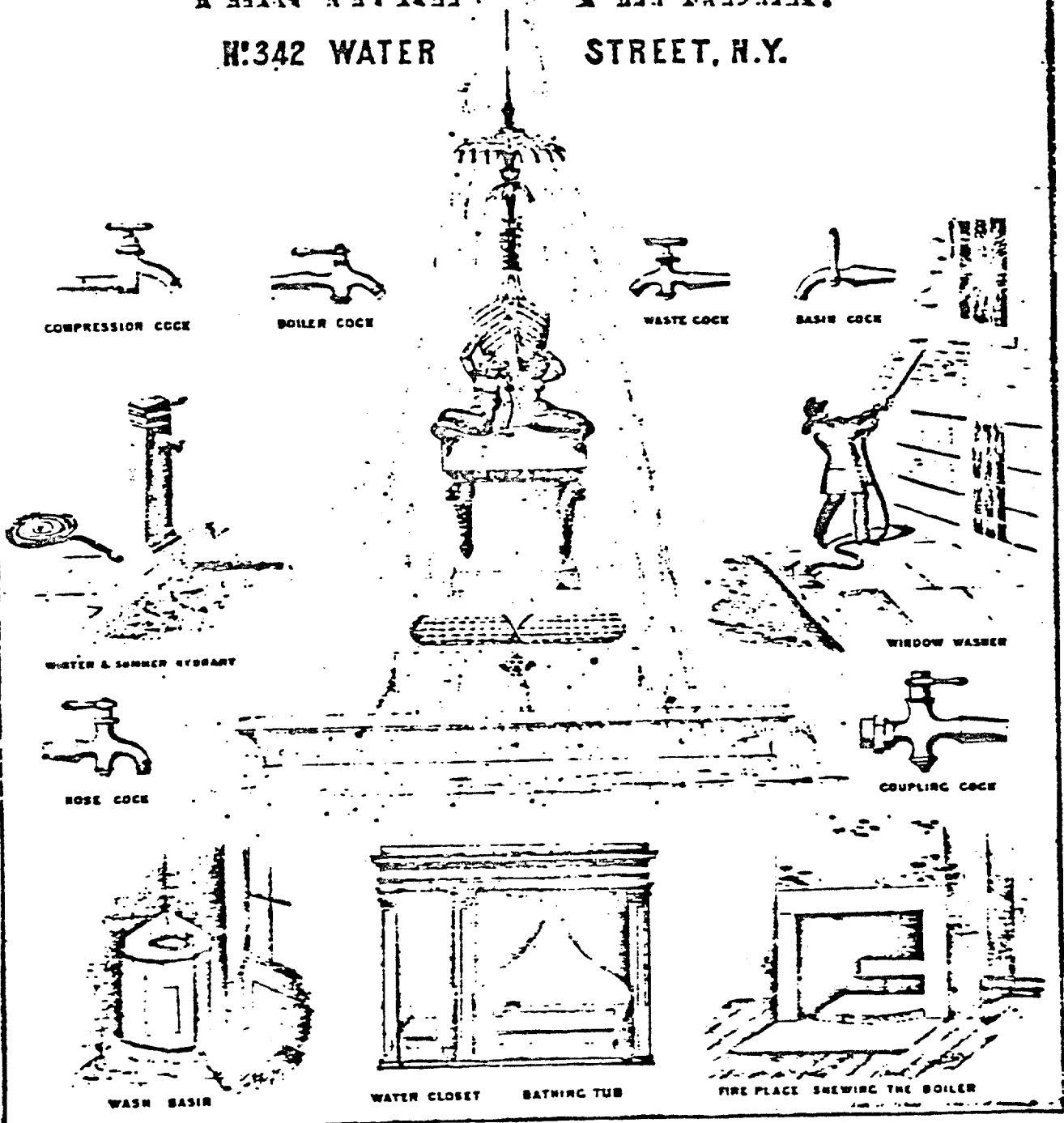

Fig. 2. J. Childs, advertisement of plumber Charles Hillsburgh. New York City, 1840-45. Colored lithograph: H. 20", W. 16 1/4". (New-York Historical Society, Bella C. Landauer Collection; Photo, Luis E. Lopez.) The poster includes a boiler on a hearth and three wood-encased fixtures.

4. Electrical System

The first electrical service to Lindenwald was installed between August 1936 and January 1937. DeProse family members suggested a 1937 date and the NPS photographs (HP20 by Melvin Weig and HP28 by Nelson E. Baldwin) show that the wire was not present in August 1936 but was present in January 1937. The system underwent changes and additions too numerous and insignificant to discuss here. The 1976 and 1977 surveys, prepared by the park maintenance staff and included in this section, document existing conditions sufficiently.

In order to restore the house to its appearance during Van Buren's residence, it will be necessary to remove or conceal all evidence of electrical equipment. The first and most important part of this process will be to conceal the electrical supply lines that bring power into the house by burying them. The location of the buried lines is affected by three factors--the archeological resources that might be disturbed by the trenching operations, the site of existing or future power supply lines, and the future placement of the main disconnect and/or panel box on the interior. Any location that would create the possibility of disturbance to subsurface resources would require monitoring of the excavation work by a qualified archeologist. It is recommended that any planned subsurface disturbance around windows 007 and 009 or the north entrance be preceded by controlled archeological excavation.

The existing overhead electrical line approaches the house from the east and continues past the south side of the house to serve the garage, trailers, and farmhouse beyond. The present service entrance and panel box is in the northeast corner of room 006.

The national electrical code requires that the main disconnect be installed at a readily accessible location nearest the point of entrance of the service-entrance conductors. The circuit breaker panel box may be located independently of the main disconnect. Considerations for the location of a panel box include accessibility, safety, and economy. The box must be readily accessible to the maintenance staff, and it must be at a safe distance from potentially hazardous equipment and in a relatively fire-resistant location. The main economic considerations are the lengths of circuits and the kinds of service equipment required.

The following are basic statements of the approach to the electrical system. There will be no permanently mounted light fixtures in the public spaces. Lighting for service spaces will be minimal, utilitarian, and accessible. Convenience outlets should be in concealed spaces near the public spaces for easy access by housekeeping crew and to provide power for floor lamps to be used for any evening events. They should also be placed near any equipment that may need servicing.

The panel box should have adequate capacity for all lights and outlets and for the mechanical, intrusion protection, and fire detection systems recommended elsewhere in this report. Those loads have been estimated at 70 amps, but in order to allow for possible additional loads, a panel box of at least 150 amps and 30-circuit capacity is recommended.

1976 Survey

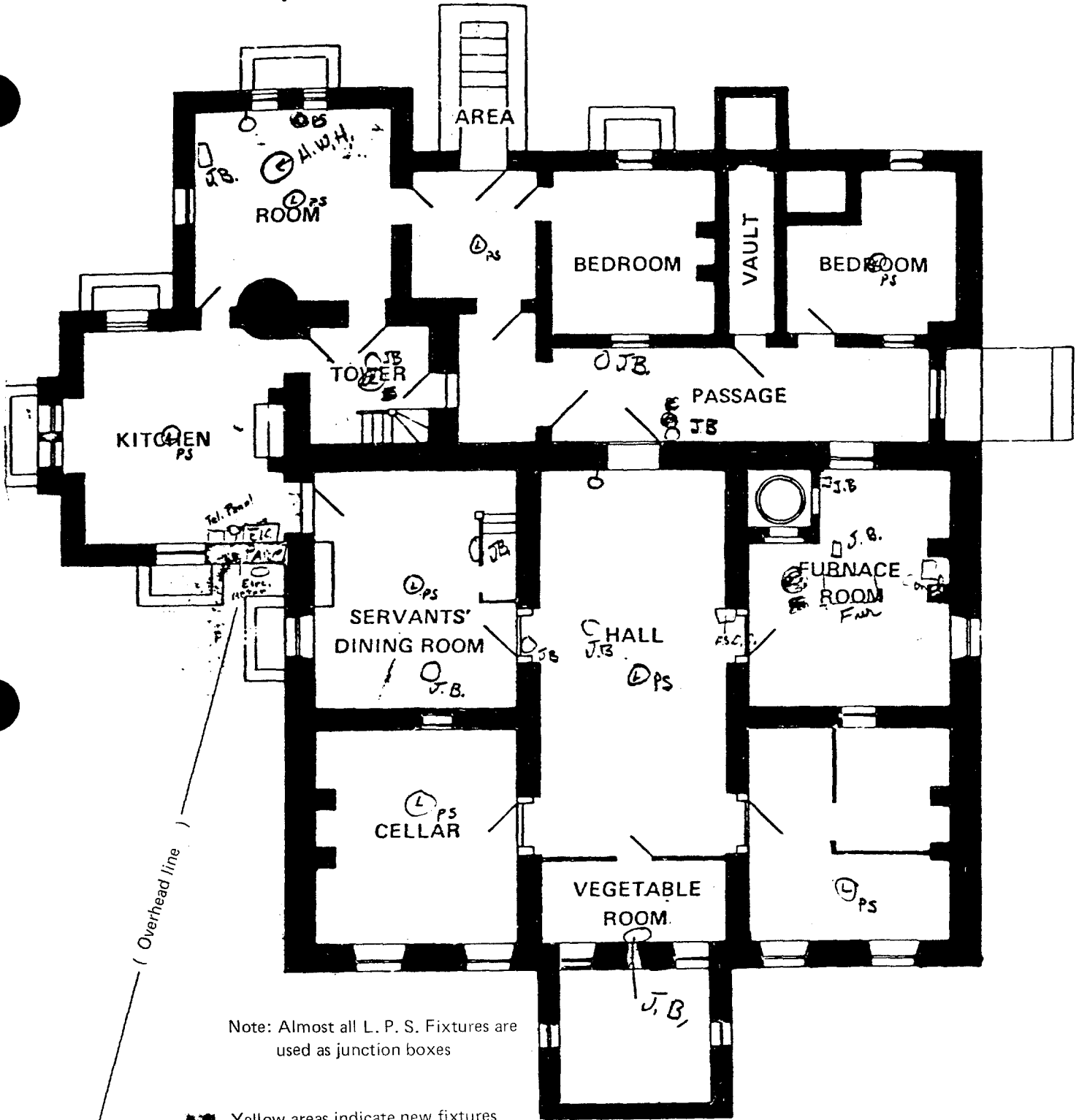

Power Pole

Basement Plan

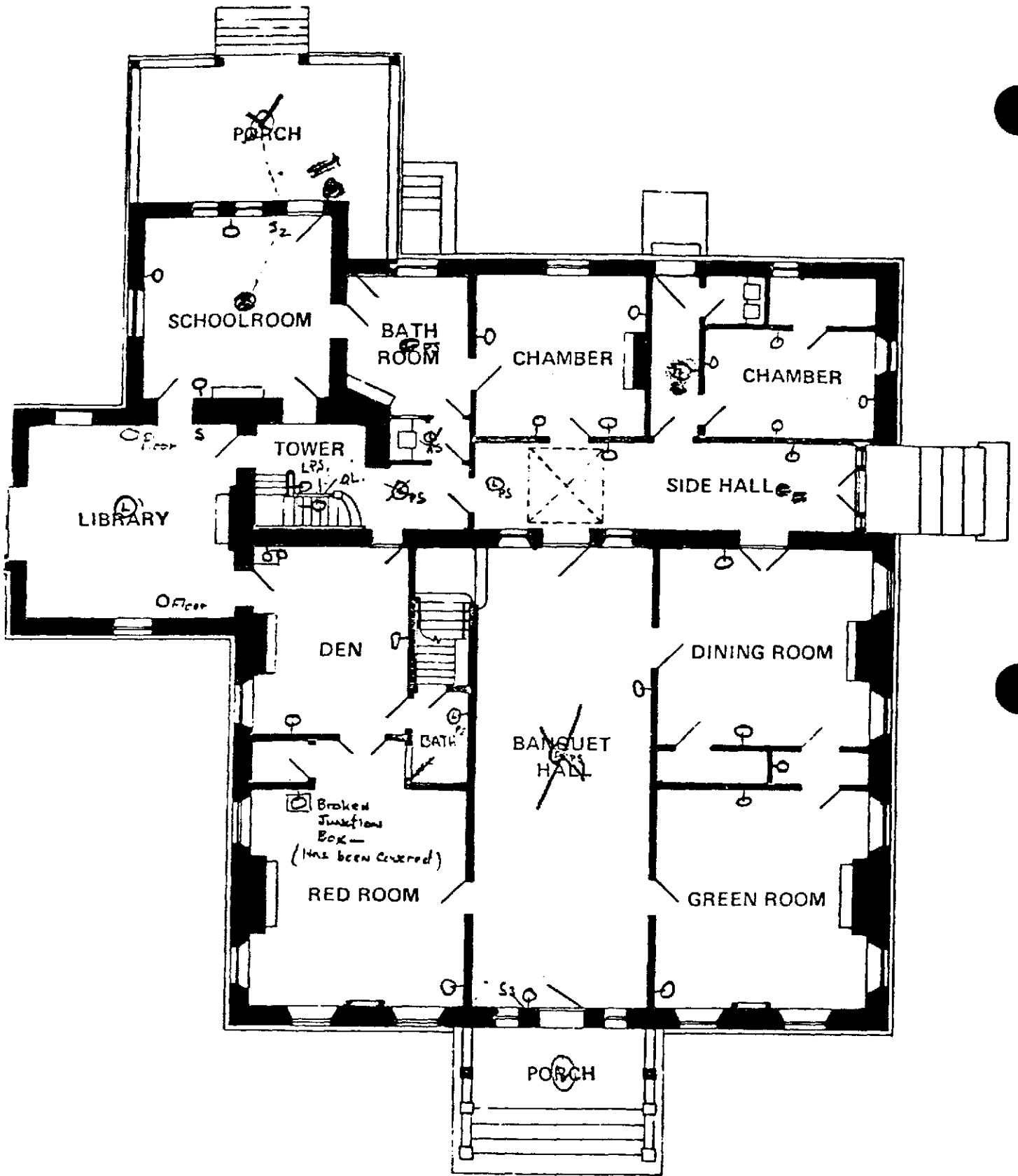

First Floor Plan

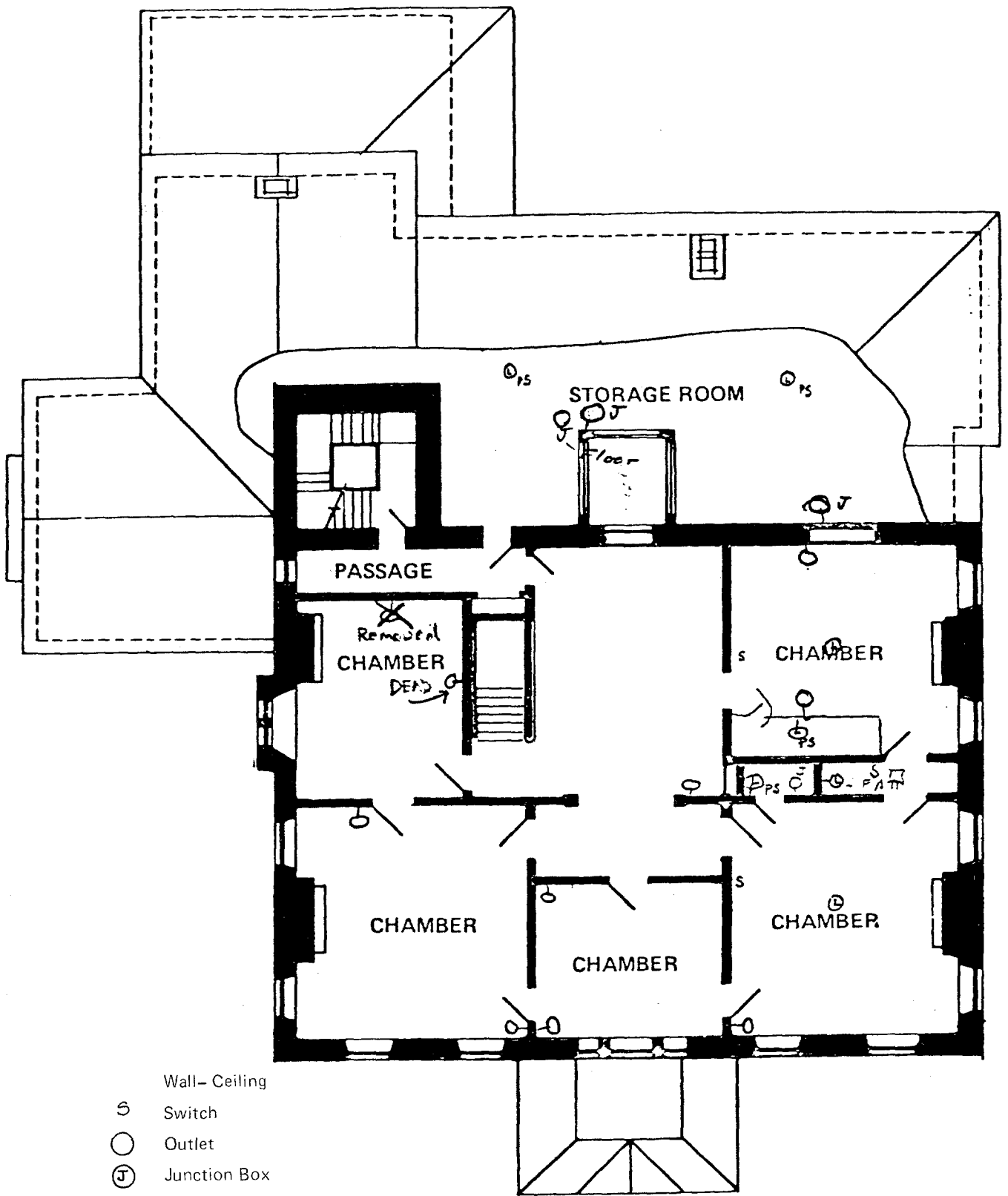

- Wall-Ceiling
- S Switch
- O Outlet
- J Junction Box
- L Lamp holder and pull switch

Second Floor Plan

Box A

- A-1 ——— 1st floor — S. Bathroom Light
 2nd floor — N.W. Rm. Ceiling Light &
 E. wall Recept. &
 Closet Light.
 N. Bathrm. Light/fan
 N.E. Rm Ceiling Light & closet light
 S.E. Rm wall recept.
 Hallway wall Recept.
 Front Center Rm, S.W. wall Recept
- A-2 ——— 1st floor — Kitchen Ceiling Light & East
 wall Recept.
 Porch Flood Lite
 Library Ceiling Lite
- A-3 ——— Basement — Pump Rm Ceiling Lite
 Hallway wall Lite (tool storage
 area)
 1st floor — Kitchen: South & west & North
 wall Recept. (Typewriter/
 Refrig. / Porch Flood Lite)
- A-4 ——— Basement — Stair well Lite
 old Kitchen Lite
 Supply Rm Lite
 N.W. Rm Lite (Below Cur-)

A-4 (Basement con.)

Helps Dinning Rm Lite
Cellar Entrance Rm Lite

1st floor — Library Floor Recept.'s
Supt. office, all wall Recept.
Side Hall, Center west wall Recept.
Banquet Hall, North wall Recept.
Red Rm S.W. wall Recept.
Den S.E. Wall & N. wall Recept.
Dinning Rm Center East wall Recept.
Green Rm Center West wall Recept.
Dinning Rm / Green Rm Bathroom —
sink Lite.

Box B

B-1 ~~Basement~~ 1st floor — S.W. Closet Recept. & Bookcase

B-2 ~~Basement~~ Basement — water Pump (Via out Let Box,
S.W. corner of pump Rm.)

B-3 ~~Basement~~ 1st floor — Curator / Historian office wall
Recept.
Side Hall', N.W. wall Recept.

B-4 ~~Basement~~ Basement — Furnace Rm Ceiling Lite
N.E. & S.E. Basement store



B-4 (con.)

1st floor — Banquet Hall — East-
wall Recept.
Maintenance Chief office —
ceiling Lite.
Side hall overhead Lites
Red Room N.E. wall Recept.
Green Room S.E. wall Recept.
Dinning Rm Center west —
wall Recept.
2nd floor — N.E. Rm wall Recept.
Front center Rm, S.E.
wall Recept.
SE. Rm, N.E. wall Recept.
Attic Lites (2) "Storage Rm"
N.W. Room, west wall Recept.

- Box C — furnace circuit
- Box D — water heater circuit
- Box E — Fire & Intrusion alarm
circuit.

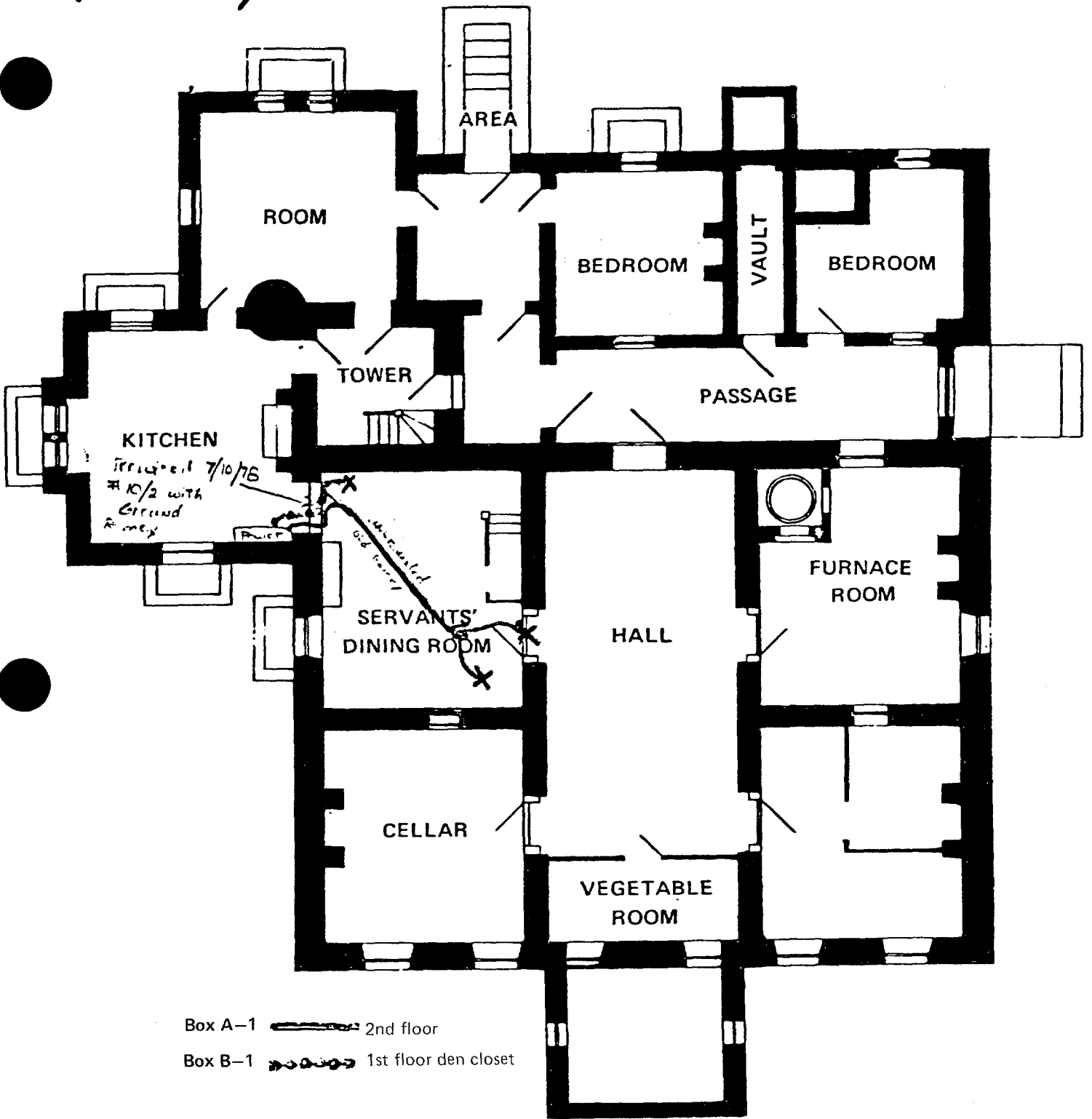
ATT Survey



Box A-1  2nd floor
Box B-1  1st floor den closet

Basement Plan

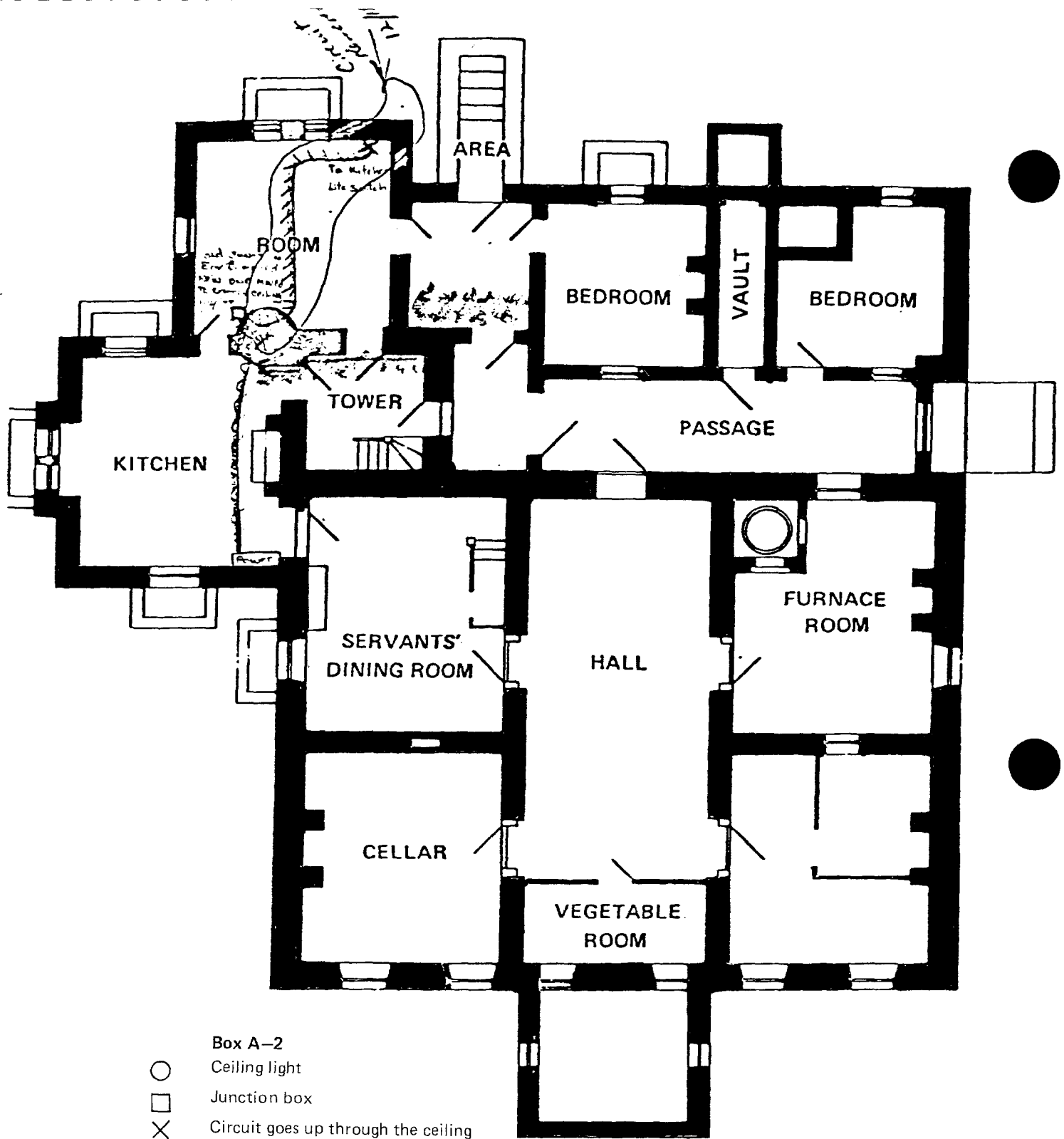

- Box A-2 Ceiling light
- Junction box
- × Circuit goes up through the ceiling
- ⊗ Circuit goes up through old Van Buren lead pipe
- Ungrounded Romex cable
- |||| Grounded Romex cable
- ~~~~ Bx cable

Basement Plan

*all circuits in R-2 grounded
 & with the exception of the R-2 feed
 to weekend Junction Box and Pump Room
 all lines are new. 11/2/77 - H.K.*

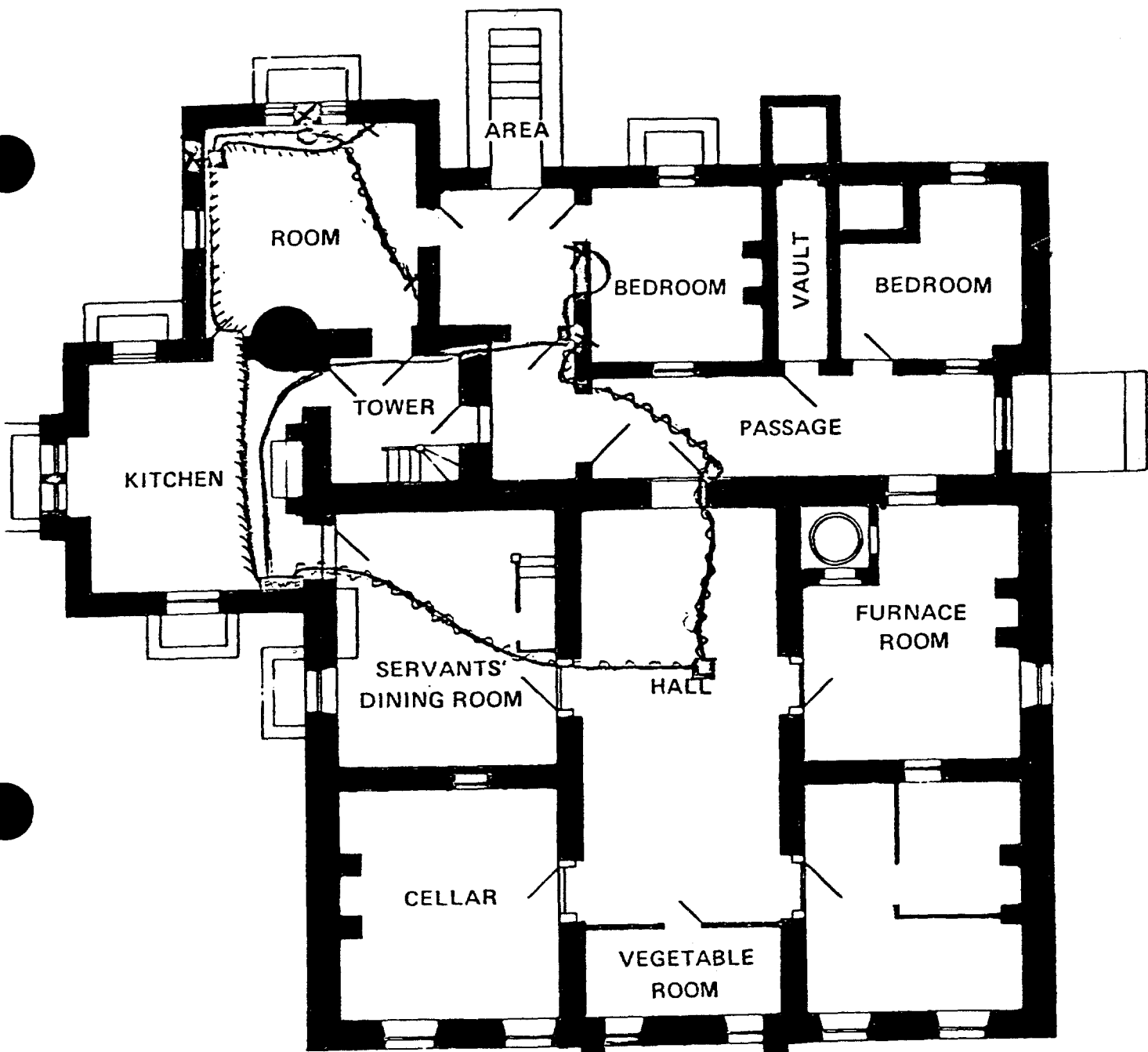

- Box A-3
- Ceiling lite
 - Junction box
 - × Circuit goes up through the ceiling
 - Ungrounded Romex
 - ▨ Grounded
 - ~ Ungrounded Romex

Basement Plan

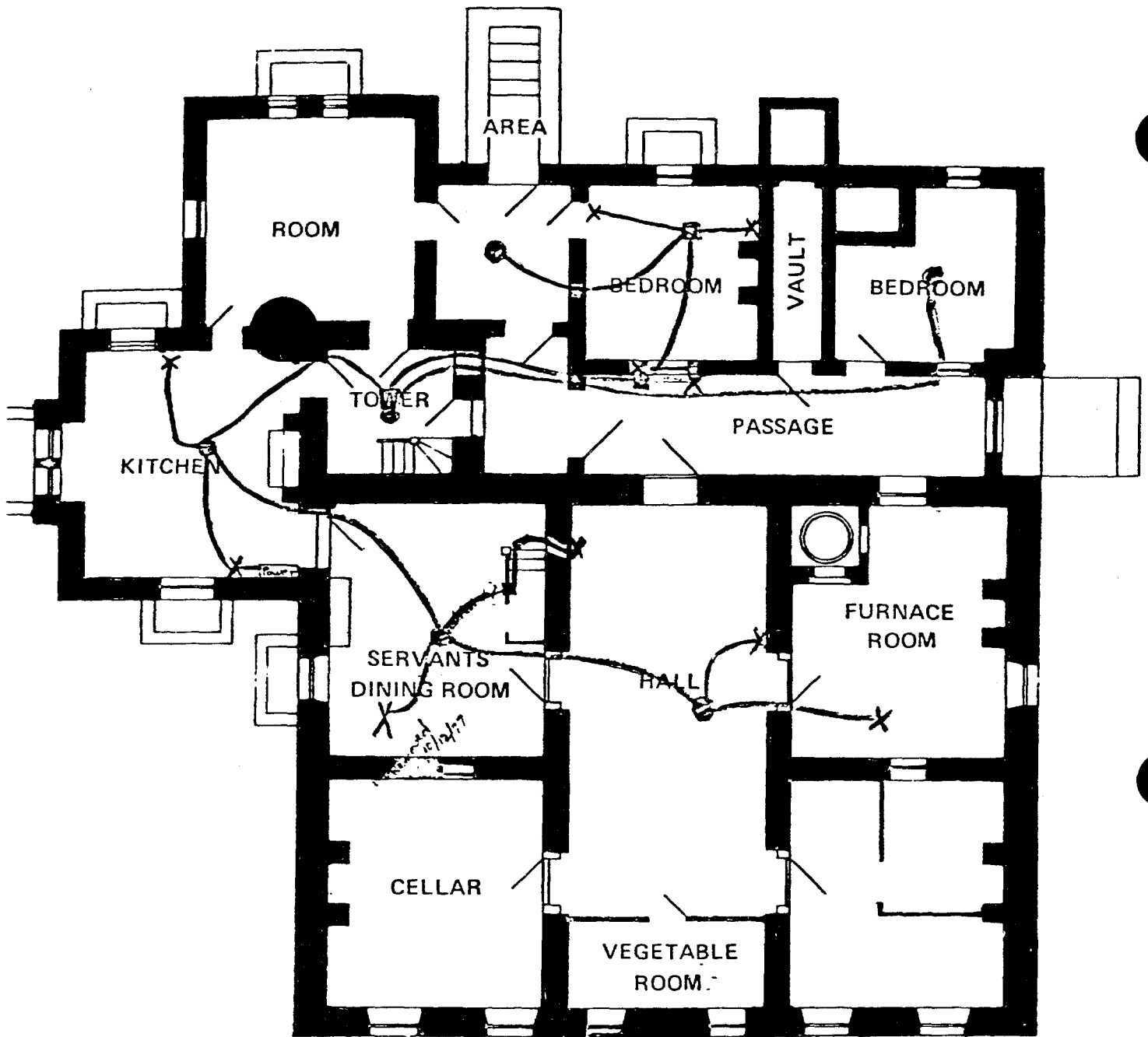

- Box A-4
- Ceiling Lite
- Junction Box
- × Circuit goes up through the ceiling
- Ungrounded Romex Cable
- - - Grounded Romex Cable
- ~ Bx Cable

Basement Plan

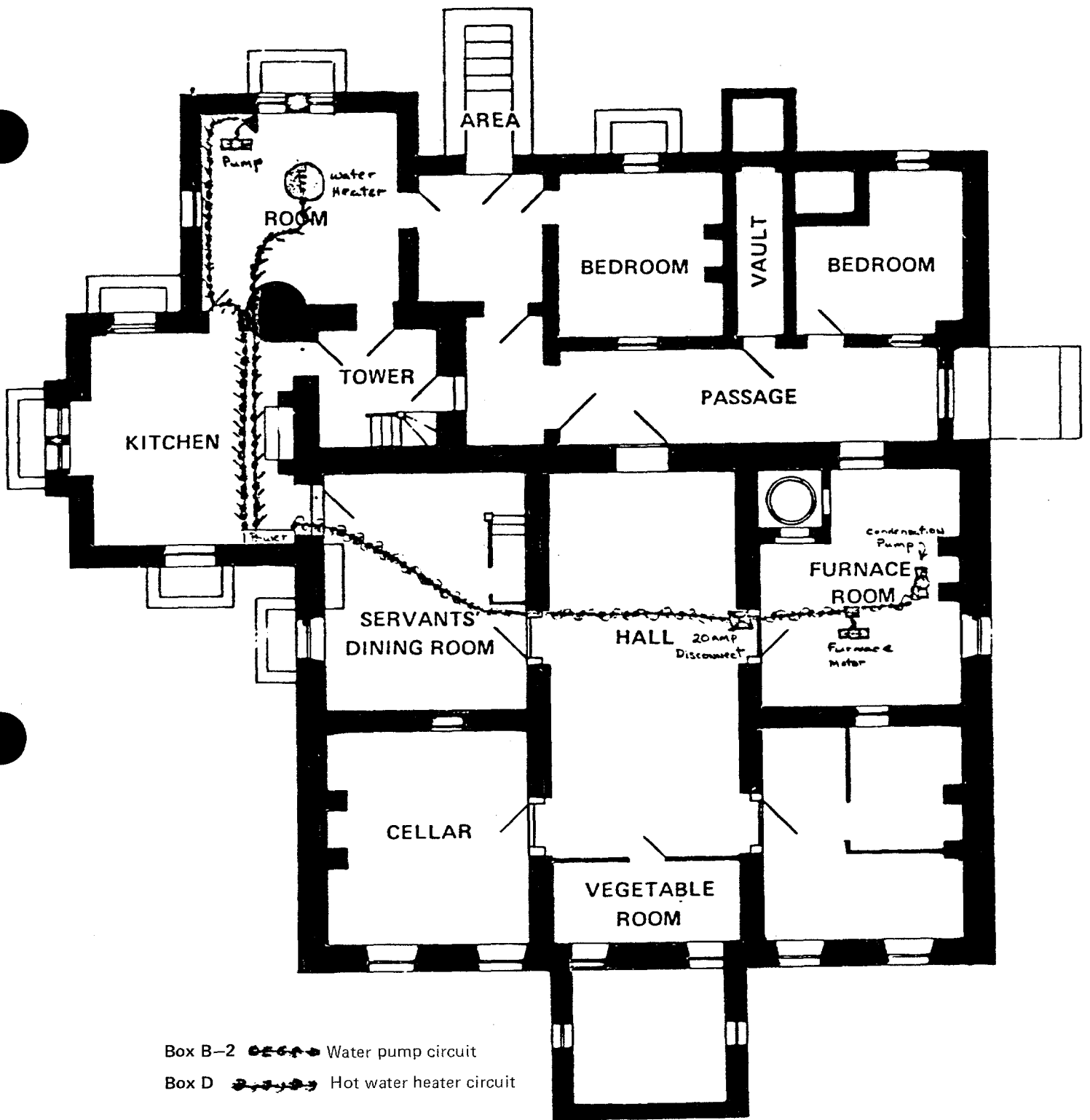

Basement Plan

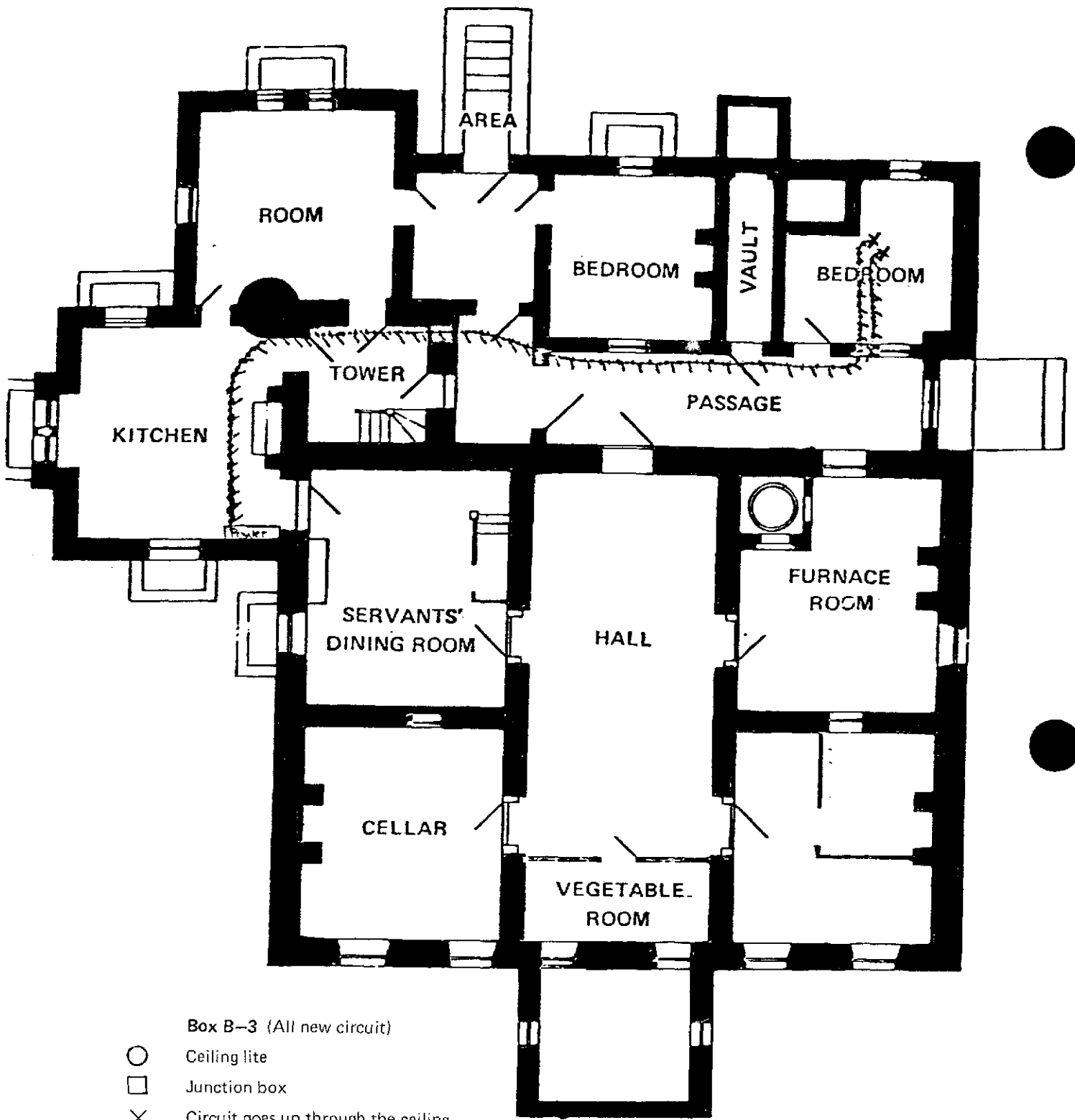

- Box B-3 (All new circuit)
- Ceiling lite
 - Junction box
 - × Circuit goes up through the ceiling
 - Grounded Romex cable

Basement Plan

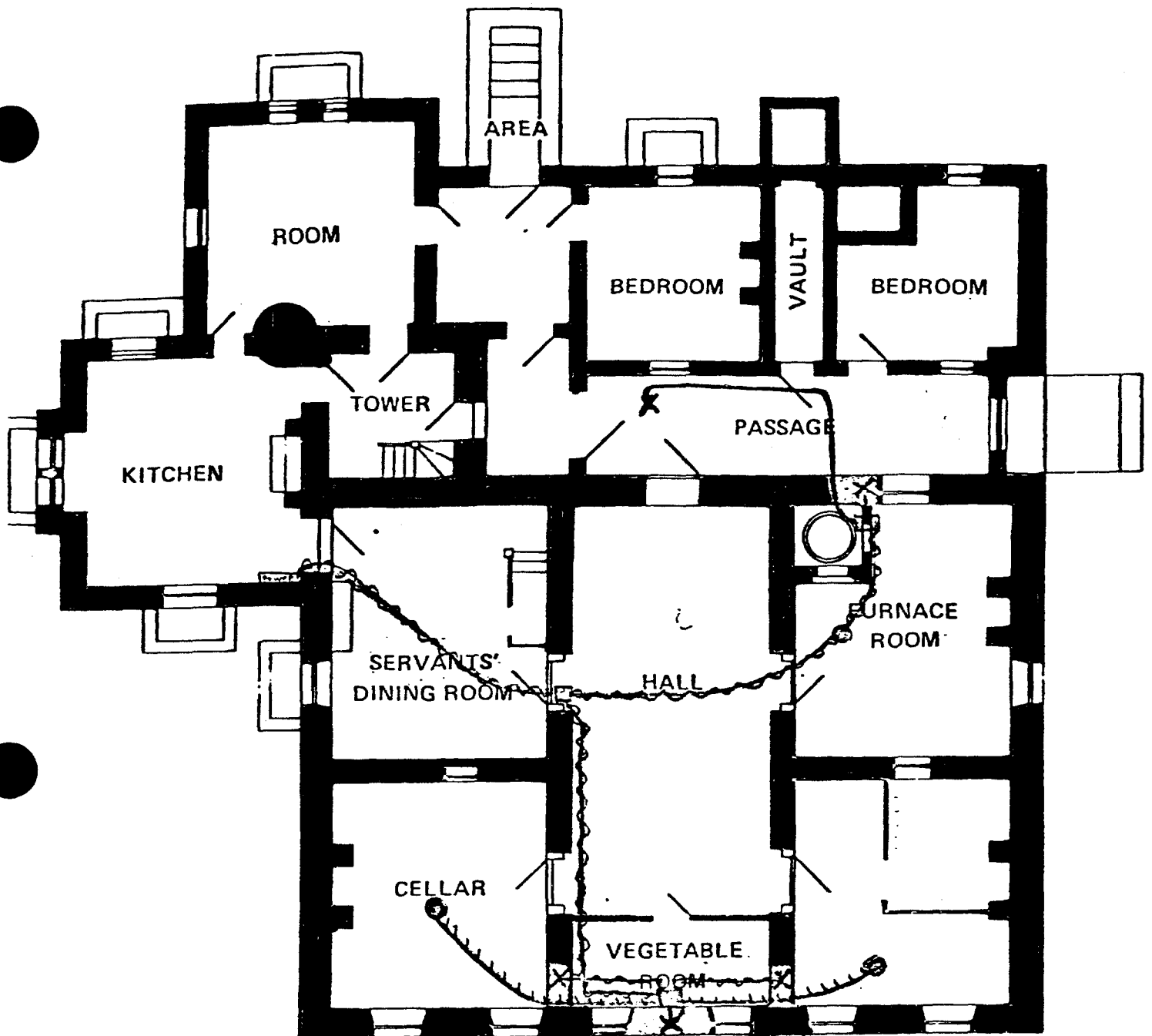

BOX B-4

- Ceiling Lite
- Junction box
- X Circuit goes up through the ceiling

— Ungrounded Romex

- - - Grounded Romex

~ ~ ~ Bx cable

Basement Plan

put back L.L. & a w. AP switch
 Line removed
 12/16/76
 During Removal
 of Drop Ceiling in
 Kitchen

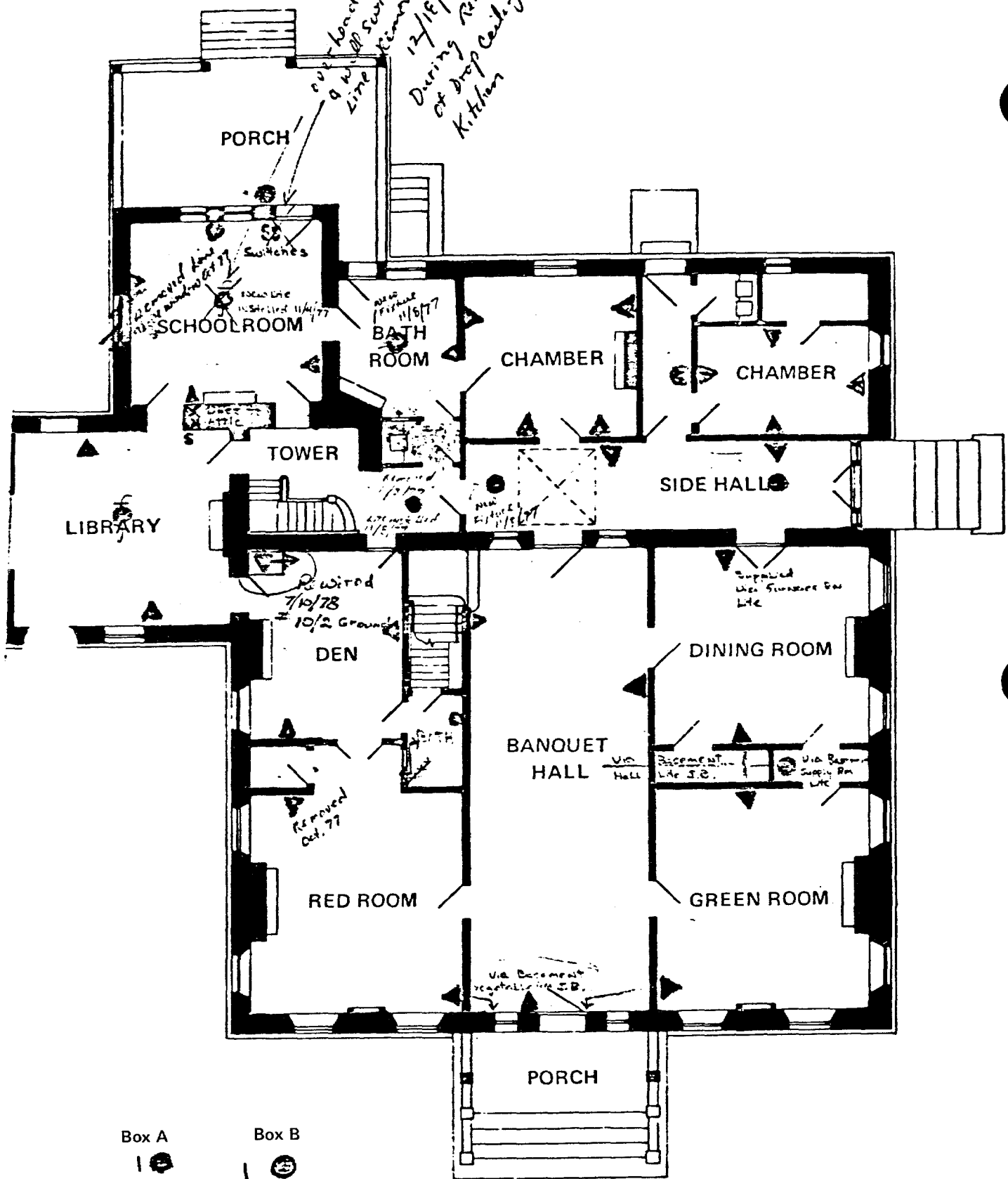

- | | |
|-------|-------|
| Box A | Box B |
| 1 | 1 |
| 2 | |
| 3 | 3 |
| 4 | 4 |

First Floor Plan

The most advisable location for the main distribution panel for the house would be in the basement in room 001, which also contains the boiler. The panel should be at a safe distance from the boiler. This location will allow all of the utility equipment to be in the same basement space, thus minimizing the disruption to historic fabric. Because bringing the feeder in from the street will require undergrounding the line, archeological involvement will be required, and because it is planned to remove the present maintenance facility, it makes little sense to bring the feeder to that building. Rather, the present underground conduit could be used to feed the maintenance facility until that building is no longer required.

Because it is planned to continue the use of the gatehouse, it is recommended that the service be brought in underground to that building and that the meter and main disconnect for the site be located there. From the gatehouse the feeder should be run underground to the north side of Lindenwald where it can enter the basement in room 001.

When this work is done, provision should be made by the archeologists for investigating the location of the underground fuel oil tank and possible conduit runs for future alarm annunciator panels at the administration trailer.

5. Communications

During the mid-19th century, Lindenwald had a mechanical bell system comprised of a series of bells hung on metal straps and connected by wire and a series of pivots to bell cranks. The wires for the system were held in place by staples; the pivots were secured with 3" cut nails.

Physical evidence found for the Lindenwald bell system indicates that only the rooms in the original house had bell cranks--rooms 101, 104, 105, 106, 201, 205, 206, and 209.* The main entrance in room 105 also appears to have had some sort of doorbell.

Additional physical evidence, although somewhat scant, suggests that the bells for the system were located in room 005, the servants' dining room; room 011, a servant's bedroom; and room 304, another servant's bedroom. The majority of the bells appear to have hung in room 005, possibly on a bell board. No evidence of this bell board has been found. Multiple bells mounted on a board are typical for the type of mechanical bell system found at Lindenwald.** Each bell in

*It would seem logical that rooms 109 and 210 would have had bell cranks as well. However, no evidence for these cranks has been found on the plaster walls or in the floorboards. In addition, there are no pivots in room 005 where, were they run like the bells in the other first- and second-story rooms, the wires would have entered the basement.

**This is the type of bell arrangement found in the "Old House" at Adams National Historic Site, Quincy, Massachusetts (NPS, Harris 1968). An October 1979 issue of Old House Journal (p. 112) identifies a bell board as typical of mechanical bell systems.

such a system was connected to a crank in a different room and had a different tone to identify for the servants from which room the call was coming. However, a round-head brass spike with a concentric arc worn in the plaster around it on the east wall and a hole with a concentric arc on the south wall, seem to indicate that there were only two bells and that they were similar to that found in room 304.

The bell in room 011 was probably a single bell. Evidence of its exact location has been obliterated by the removal of all the original plaster in this room; however, the routes of the bell wires in room 001 lend strong support to the location of a bell in this room. In room 304 a single bell is still in place on the north wall.

The Lindenwald bell system appears to have been installed prior to ca. 1850; however, the exact date of its installation has not been determined.* Most of the evidence for the bell system has been found in the original house. No evidence of bell cranks has been found in the Upjohn addition, although there is a pivot in room 007 and a bell in room 304 (a servant's bedroom), and wires in room 001 once led to room 012. All, however, appear to be additions to the original bell system. Staples found in room 304 are larger than the staples found in the original house.

Because mechanical bell systems were not installed in most American homes until the early 19th century, it does not seem likely that the system dates to the building of the house in 1797.** A similar system was installed at the "Old House," Adams National Historic Site, in 1850 by Charles Francis Adams.*** The close similarities between the two systems and the fact that the Lindenwald bell system was installed only in the principal rooms of the original house suggest that Van Buren probably had the system put in during the ca. 1840 alterations.

a. Identification of the Components of the System

(1) Bells

Only one of the bells from the Lindenwald bell system has been found. It hangs on the north wall of room 304, a

*Comparison of paint samples taken from the wood block and plaster cornice in room 105 did not provide any information for dating the installation of the bell system. Samples of both areas contained only about two layers of white paint, indicating that they were painted infrequently. Chemical testing with HCl indicated that both layers are calcimine paint, making it difficult to distinguish between the individual layers and between the plaster surface and paint on the cornice.

**The installation of bells in homes in the U.S. is associated with the employment of servants in American homes. This did not occur until early in the 19th century. See Mark Girouard's Life in the English Country House (Yale University Press, 1978).

***This installation is recorded in the Financial Ledger Miscellany, Charles Francis Adams, August 16, 1850: "August 16. Paid Mr. S. W. Fuller for hanging bells at the house in Quincy \$23.50" (Quoted in NPS, Harris 1968, 622).

servant's bedroom on the third floor. It is made of brass, its mouth is 3" in diameter, and it stands 2-1/2" high. It is attached to a curved metal strap, which is attached to a forked pivot. To the left of this bell, at a distance of 1' 6", is the nail that held a spring. This spring was attached to the forked bell pivot. It maintained the tension in the system, causing the bells to ring when the cranks were pulled. This spring is no longer in place. To the right of this bell, at a distance of 1' 3", is a pivot that allowed the bell wire to change from a vertical direction to a horizontal direction. It seems likely that the other bells in the system were similar to this one in appearance and function. Their size, however, probably varied, so that their tones were different.

(2) Bell Cranks

Two of the Lindenwald bell cranks have been found, both removed from their original locations. One crank turns clockwise; the other turns counterclockwise (the handles are located on the right and left sides respectively). Each is made of brass and consists of a plate, measuring 3-1/2" long by 1-5/8" wide, with a circular frame for the crank turn in the center. The part of the crank that turns in the circular frame is attached to a brass link chain and to a curved brass handle. The brass link chain is roughly 4-3/4" long and at its end connects with the bell wire. When the crank is pulled, the chain wraps around the circular part of the crank, tightening the wire which rings the bell. The curved brass handle has a carved ivory knob at its end and bears the name J. Blackall.* The cranks appear to have had a cover that was screwed onto the threaded post in the center circular frame of the crank. The exact shape and design of this cover is not known. The bell cranks were secured to the walls with four screws (probably brass flathead screws).

(3) Pivots

Numerous pivots for the Lindenwald bell system are still in their original locations. They were used singly, or in various combinations, to enable the bell wire to turn corners and change direction.

Three types of pivots were used in the Lindenwald bell system. Hereafter, they will be referred to as pivots A, B, and C. Pivots A and B are of similar design and function. They are made of brass and are roughly the shape of an equilateral triangle, with curved edges. The base of the triangle (at its widest point) is approximately 2-3/4" and its height is 1-7/8". In each corner of base of the triangle is a hole through which the bell wire was attached. The only difference in design between pivot A and pivot B is a bar, roughly the shape of the sides of the equilateral triangle, which has been inserted into the center of pivot B. This difference in design does not appear to correspond with a difference in function or time of installation. Pivots A and B are attached to the plaster walls and wood beams with 3" wrought nails.

*New York City and Boston directories, 1830-60, contain no information about a J. Blackall. Inquiries sent to the Victoria and Albert Museum in London also revealed no information.

Pivot C consists of a brass plate onto which a brass pivot is mounted. The brass plate is approximately 3-1/2" long and 7/8" wide. In its center is a roughly key-shaped hole through which the pivot passes. The pivot itself is similar in shape to pivots A and B, but is smaller and has a straight bottom. Its base measures 2-1/8" and it is roughly 1" high. Only two of these pivots have been found at Lindenwald. One is still in place above the main entrance door in room 105, mounted in a wooden block. The other one was found loose in the house. It seems to fit a mortise in the south architrave of door 101.

(4) Bell Wire

The bell wire used for the Lindenwald bell system is AWG 18 gauge (0.040"). Some of the wire is copper and some is iron. The wire was attached to the various mechanical elements of the system cranks, pivot, and bell strap by looping it through the holes in the elements and then twisting it back around itself.

(5) Staples

The wire for the bell system was held in place with tiny staples. These staples are iron wire and measure 3/4" long by 1/4" wide.

b. Functioning of the System

Physical evidence of the bell system at Lindenwald suggests that it functioned as follows.

(1) First Floor

(a) Room 101

In this room the bell crank is on the east side of the fireplace, at a height of approximately 3'5". Patches in the plaster indicate the location of the bell crank. A pencil line, above and below the plaster patch, indicates where the wires from room 201 and room 101 ran down the east side of the chimney. On either side of this line are two sets of tiny holes, made by staples that held the wires in place. In the floorboard directly below the line is a small hole from which two small wires project. Immediately below this hole in the basement on the wooden beam in room 001 are two pairs of pivots. These pivots appear to have allowed the wires to turn at this point and run in a easterly direction to the east wall of room 001, where they turned, with the aid of another set of pivots and ran in a southerly direction across the room. Staples in the beams indicate the route of the wires across the room. The wires then appear to run through the south wall of room 001, across room 003, and into room 005, the servants' dining room. In the servants' dining room they appear to have been attached to a bell, probably on a bell board.

(b) Room 104

The bell crank in this room is on the west of the fireplace at a height of approximately 3'5". The shape of the plate of the bell crank is clearly outlined by the layer of wallpaper and paint that are currently on the walls, indicating that it was in place when the room was last painted. The bell wire from this crank ran vertically down the chimney breast, through the floorboard, and into the basement (room 002A). Evidence for the route of this wire includes staple holes in the

plaster and baseboard and a small hole in the floorboard. In room 002A the wire appears to turn, with the aid of a pivot, and run in a westerly direction into room 001. In room 001 the wire appears to turn with another pivot and run along the same route as the wire for the bell crank in room 101.

(c) Room 105

Evidence for the bell system in this room consists of a wooden block in which a type C pivot is inserted. The block measures 7-3/4" long, 4" wide, 2" thick, and is held in place by six cut nails. Directly below this block, in the interior casing of door 101, is a hole over which it appears another type C pivot fit (it is no longer in place). Evidence suggests that they were part of the door bell. Exactly how this door bell functioned is not known. It appears that the wire from the door pull ran vertically up the wall to the pivot in the wooden block. There it turned and ran in a westerly direction. A bell hanger can be seen in the casing of door 130 in historic photograph 13. Investigation of this area revealed the patched hole where the hanger was located. Presumably the bell wire was strung without support from the wooden block to the bell. No evidence has been found in this room for a bell crank that would have been connected to the servants' quarters or kitchen.

(d) Room 106

As in room 104, the bell crank in this room is on the west side of the fireplace. Again, it is at a height of approximately 3'5", as indicated by the patches in the plaster wall surface. The wire from this bell crank ran vertically down the chimney breast and into basement room 004. Staple holes in the plaster and baseboards and a small hole in the floorboard, in line with the bell crank, reveal its route. A pivot where the wire ran into room 004 suggests that the wire turned and ran in a westerly direction into room 005, the servants' dining room. In the servants' dining room it appears to have been attached to a bell, probably on a bell board.

(e) Room 109

No evidence of the bell system has been found in this room.

(2) Second Floor

(a) Room 201

In this room the bell crank is on the east side of the fireplace at a height of approximately 3'5". The bell wire ran vertically down the wall and into the floorboard directly below the crank. Evidence for the placement of the bell crank and the route of the wire consists of plaster patches, staple holes in the plaster and baseboard, and a small hole in the floorboard. It then appears to have run vertically down into room 101. Plaster patches below the cornice obliterate any evidence of where this wire entered room 101. However, two bell wires projecting from a hole in the floorboard on the east side of the chimney indicate that it ran exposed through this room. Once under the floorboards, it appears to have followed the route of the bell wire from room 101.

(b) Room 205

The bell crank in this room is on the west side of the fireplace, at a height of approximately 3'5". The bell wire ran vertically down from the crank and into the floorboard. There it appears to have run vertically down into room 104. Staple holes in the wall of this room above the bell crank indicate that the wire ran exposed down the west side of the chimney. It appears to have run into the floorboard and into room 002A, where it followed the same route as the bell wire coming from room 104.

(c) Room 206

In this room the bell crank was on the right side of door 209, leading into room 201. This crank was at a height of 5', as indicated by the screw holes found in the frame. From the crank, the wire ran up the door casing through a hole drilled in the cornice of the frame to the ceiling. At ceiling height, the wire appears to have turned and run in an easterly direction into room 207. In room 207 it turned again, running in a vertical direction up into room 304, a servant's bedroom. A hole in the plaster cornice identifies the route of this wire. In room 304 the wire continued to run vertically up the north wall to a height of 7'4". There it turned, with the aid of a pivot, and ran in a westerly direction to the bell. The bell and pivot are still in place. More than 18" to the left of the bell is the roundheaded nail that held a spring, also attached to the bell in place. This spring kept tension in the system and enabled the bell to ring when the crank was pulled. The crank in room 206 is the only second-floor crank that seems to have been connected with a bell on the third floor. All of the others appear to have been connected to basement bells.

(d) Room 209

In this room the bell crank was again on the west side of the fireplace at a height of roughly 3'5". The wire from the crank ran vertically down the wall and into the floorboard. Evidence for locations of the crank and the route of the wire consists of plaster patches, staple holes in the plaster and baseboard, and a small hole in the floorboard directly under the crank. Under the floorboard the wire appears to have run, exposed, through room 106, down into basement room 004. In the basement the bell wire followed the same route as the bell wire from room 106, described above.*

(e) Room 210

No evidence for the bell system has been found in this room.

*Unlike the bell wires in the other two second-floor bedrooms (201 and 205), the bell wire in room 209 does not appear to have run into a central closet area before running into the basement. There are no pivots in the southeast corner of room 005, where the wire would have run into the basement if it had run through room 107. In addition, the fact that there are two pivots in room 004 indicates that probably two wires came into the room at this point.

(3) Basement

Most of the evidence of the bell system found in the basement consists of the pivots, staples, segments of wire, and bells for the first- and second-story bell system described above. However, some of the evidence in the basement, particularly in room 001, does not fit into this system and merits further discussion. As noted on the basement floor plan, there are several pivots located in room 001 that do not seem to have been used to run wires to the bells in the servants' dining room, room 005. These pivots are next to the fireplace and on a ceiling beam in the center of the room. This central pivot suggests that at least one of the bell wires coming from the rooms on the north side of the house turned at this point and ran in a westerly direction into the hall (room 012). No evidence has been found in room 012 for where this bell wire ran. It seems likely that it would have run into room 011, a servant's bedroom, or room 007, the laundry room. No evidence remains for a bell in the servant's bedroom; all the original plaster in the room has been destroyed. In the laundry room there is a pivot on the north wall that may have been associated with a bell. A row of staples on a beam on the north wall of room 003 may also have been associated with the bells in rooms 007 and 011. The exact route of the bell wires held in place by these staples has not been determined.

c. Recommendations

Visible elements of the Lindenwald bell system should be reproduced and installed in their original locations. These elements include bells, bell cranks, wire, and pivots. No effort should be made to make the bell system operational.

6. Lightning, Fire, and Intrusion Protection

a. Lightning Rods

The lightning rods found at Lindenwald are composed of 10' fluted iron conductors twisted spirally (see IP103), 1-1/4"-long octagonal iron connectors, and a 14" conical copper point (see the illustration at the end of this section and IP102). The lightning rods were secured to the building with metal clasps and glass insulators. The glass insulators are marked "Kretzer Brand". On the brick walls of the tower and the house, these metal clasps were anchored to wooden blocks set into the brickwork. The lightning rods were on the tower and on the north and south ends of the ridge of the roof of the ca. 1797 house (roughly 6' from the edge). Replacement sections are spiral-fluted sheet copper with brass connectors marked "R.H. Co." (see IP104).

The tower lightning rod was grounded on the south side of the house, in the corner where rooms 111 and 112 meet. The conductor ran up this corner, across the metal roof, and over to the south wall of the tower. On the south wall of the tower it ran up on the west side of the windows. The point was mounted on a wooden shaft secured to the ridge of the tower roof.

When the National Park Service acquired Lindenwald in 1974, two portions of the tower lightning conductor were still in place. The copper point was also in place, mounted on a long wooden pole, as were the segment of conductor that ran along the south wall of room 112 and a 20' segment at the top of the tower. The pole probably is not the

wooden shaft on which the point was originally mounted. The missing portion of the tower lightning rod was found on the grounds at Lindenwald. Wooden blocks in the brickwork and metal clasps in the wooden blocks and metal roof indicate the route of the portions of the lightning rods that have been removed.

The lightning rods on the east elevation of the house were grounded at its north and south corners. They ran up the east wall, inset a distance of approximately 21" from their respective corners. At the top of the brick walls they ran around the cornice and continued up the roof to its ridge. The points of these lightning rods also appear to have been mounted on wooden shafts, secured to the roof ridge (see HP10).

Both of the lightning rods from the east elevation have been removed, and no elements from these rods have been found at the site thus far. Physical evidence of their routes consists of wooden blocks set into the brickwork and metal clasps in the wooden blocks.* A ca. 1890 photograph of the house also shows the route of these lightning rods.

The exact date of installation of the lightning rods is unknown. No written documentation relating to their installation has been found. In Upjohn's rendering of Lindenwald, ca. 1849, no lightning rods are visible. Whether such a small architectural element as a lightning rod would be included in an architect's rendering is uncertain. Early photographs of the house, ca. 1890 and 1900, do show the lightning rods, establishing their installation by this date.

Since the installation of the lightning rods cannot be accurately dated, the question arises of whether the lightning rods were installed at Lindenwald during Van Buren's residency. Stylistically, they resemble lightning rods that were patented during the mid-19th century. The twisted iron rod is similar in shape to the iron-covered copper rod patented by L.S. Baldwin, August 9, 1854 (Patent 25,077, BPL). The point, although of copper, rather than a mixture of steel, brass zinc, and silver, is the same shape as the lightning rod point patented by J. Spratt, May 4, 1852 (Patent 8,930, BPL).

*On the north corner of the east elevation, Portland cement patches in the third, sixteenth, and fortieth courses of brick above the water table mark the location of the clasps of the north lightning rod. Wooden wedges with metal clasps at the fifth and twentieth courses above the decorative brick course separating the first and second stories identify the upper route of this lightning rod.

On the south corner of the east elevation, Portland cement patches in the fifth, thirteenth, twenty-third, and forty-first courses of brick above the water table mark the location of the clasps of the south lightning rod. Wooden wedges with metal clasps at the sixth and twenty-third courses above the decorative brick course separating the first and second stories identify the upper route of this lightning rod.

The glass insulators, however, do not appear to be stylistically correct for the mid-19th century. No patents were issued for glass insulators before 1870, and articles published during the 1880s and 1890s heatedly discuss the effectiveness of this new device. Whether these insulators for the lightning rods were installed with them originally is not known.

One other piece of noteworthy documentation relating to the lightning rods is a series of correspondence between Richard Upjohn and a Mr. Ward regarding the installation of lightning rods at Ward's house in Lenox, Massachusetts, in 1846. Ward wrote to Upjohn asking him if he knew of anyone who could install lightning rods on his house and farm buildings. Upjohn's response to this letter has been lost. Ward's next letter to Upjohn refers to a man named Quimby, who was probably the person who installed the lightning rods. Quimby was to charge \$50 for the house and \$10 for the barns (Upjohn Papers). This correspondence indicates that Upjohn was using lightning rods on his buildings, even though there is no conclusive evidence that he used them at Lindenwald.

Lindenwald's location on the ridge above the Kinderhook Creek requires that the house be protected with lightning rods. Because the lightning rods found at Lindenwald are stylistically similar to lightning rods patented during the period to which the house is being restored, and their historical use at the house is certain, it is recommended that these lightning rods be reinstalled at Lindenwald. Missing parts of the lightning rod system should be reproduced.

The conductors should be made of 3/4" star-section iron strips, twisted spirally. The individual segments should be 10' long; their ends should be tapered to a 1/2" screw connection. The segments should be joined by 1-1/4", octagonal brass screw connectors. Glass insulators should be installed along the rods where they are secured to the building with metal clasps. The insulators should be circular and 1-1/2" high. Their inner diameter should be 1" and their outer diameter 2". The insulators should be secured to the building with metal clasps. On the brick surfaces they should be fastened into wooden blocks inserted into the brick work.

The lightning rods should be placed as they were originally on the house--on the tower and north and south ends of the ridge of the original house. As a general rule, the protection offered by a lightning rod is circumscribed by a cone the side of which is at a 45 degree angle to the rod. Since by these modern standards much of Lindenwald lies uncovered by this early system, additional protection is deemed necessary. Modern lightning rods should be used to supplement the historic lightning rods. They should be located along the ridges of the roof of the house. The type of modern rod used and their exact locations should be determined by the historical architect during preparation of construction documents.

b. Fire Detection System

The fire hazards at Lindenwald should be minimized. Outdated and unsafe wiring should be removed. The oil-burning boiler

and its flue should be replaced. Smoking should not be allowed. In selecting a fire detection system of Lindenwald, consideration should be given to its sensitivity--speed of detection, dependability, and the ease with which its detectors can be concealed. Detectors should be placed so that they maximize the system's sensitivity to detect a fire but intrude on the historic fabric of the building as little as possible.

The placement of detectors at the perimeter of the room, such as on the ceiling over doorways, is usually least intrusive. Detectors should not be placed too close to the wall because dead air spaces, which may occur where the walls and ceiling meet, can delay the detection of the fire. National Fire Protection Association standards recommend that detectors be placed at least 6" from a wall.

In some rooms it may not be possible to place the detector at the perimeter. Central placement may result in a considerable intrusion on the historic integrity of the room, for example, exposed wires running through it. Where such placement restrictions occur, imaginative design, using removable detectors or detectors that must be adjusted for full operation, may be required.

It is recommended that a system like, or equal to, that manufactured by Pyrotronics of Cedar Knolls, New Jersey, utilizing the DI-4 ionization detectors or Unitec UT-310 or UT-315 ionization detectors as manufactured by Unitec Incorporated of Englewood, Colorado, be installed. The DI-4 can be mounted so that it projects into the space 2-3/4" and is roughly the shape of a frustum of a cone with a base of 5-1/4" diameter and a top of 2-3/4" diameter or so that it projects 1-1/2" into the space with a 5-3/4" base plate and a 2-3/4" diameter cylinder. The latter installation requires a 4"-square hole in the substrate; the former requires only a 1"-diameter hole. The Unitec detectors can be mounted so that a 6-1/2"-diameter plate projects only 3/8" into the space or so that a 6-1/2"-diameter cylinder projects 2" into the space. The former installation requires a 3"-square hole in the substrate; the latter requires a 1"-diameter hole.

c. Fire Suppression System

At the present time, Lindenwald has no automatic fire suppression system. Installation of a new system is not considered suitable because it would entail damaging much of the historic fabric of the building and under certain uncontrollable and unalterable conditions, it would not be effective.

Of the various fire suppression systems commonly available, only the water sprinkler and the Halon system are feasible for installation at Lindenwald. Neither, however, is suitable for use in a historic structure. The sprinkler system is not acceptable because of water damage that can occur to furnishings if the system is set off. The Halon system requires confinement to work effectively. With deep-seated, wood-fueled fires, this confinement must be for as long as several minutes. Since it is expected that windows will be opened at certain times of the year and some doors will remain open on the interior, confinement of the Halon would be extremely difficult and highly expensive.

Halon is, however, an excellent fire extinguishing material, and it is recommended that a number of Halon extinguishers be acquired and placed in concealed, but accessible locations in the house for immediate response to an alarm and that a large cache of Halon extinguishers be kept in the maintenance building for use by park staff or the volunteer fire department. As a supplement to the Halon extinguishers, there is a 12,000-gallon water tank about 150' north of the house and a farm pond about 500' south of the house. The water could only be utilized by the fire department pumper tanks. The Stuyvesant Falls, Stuyvesant, and Kinderhook fire departments can be dispatched by the Columbia County fire dispatcher. All have received special training for firefighting at Lindenwald.

d. Intrusion Protection Systems

The purpose of an intrusion detection and alarm system is to protect the resources against vandalism or theft. A system is effective if it results in deterrence or apprehension of would-be intruders or pilfering visitors. Four essential and equally important elements must be present to create an effective intrusion protection system:

Detection and assessment systems must detect and verify any intrusion or pilferage.

Communication systems must ensure that the proper authorities are notified so that they can respond to the intrusion and/or notify the intruder that his presence has been detected.

Delay systems must impede the intruder's progress.

Response systems, or forces, must be available to apprehend or repel the intruder(s).

Detection and assessment systems generally have the greatest effect on the physical fabric of the resource being protected. Detection systems are usually classified in four levels of protection:

Perimeter protection surrounds the building at a distance to detect the approach of an intruder. This type of protection would not be appropriate at Martin Van Buren National Historic Site.

Building penetration systems detect any intrusion throughout the building envelope. A building penetration system at Lindenwald would consist of magnetic reed switches or microswitches on every accessible exterior opening and the wiring necessary to connect them to a communications and control system. There are four doors and 46 windows to be protected in the basement and first floor of Lindenwald. Protection of the second-floor openings would require detectors for an additional 16 windows. Wiring of a building penetration system would require extensive removal of historic plaster from the exterior walls.

Interior protection systems detect the presence of an intruder within the protected space. An interior protection system could consist of

many different types of sensors for different purposes. The main types of sensors that could be used at Lindenwald are ultrasonic, microwave, infrared, audio, door switches, and pressure mat devices. A decision of which type (or types) to employ and where to locate them should take into account information to be presented in the interpretive prospectus and the furnishings plan.

Point protection systems detect the disturbance of an object or the presence of an intruder at a specific location. A point protection system would only be employed for the protection of a particularly valuable and/or portable object. Decisions on the installation of this type of protection should be made in consultation with a curator and should be appropriate to the anticipated types of tours (guided or self-guided).

An assessment system normally consists of devices to determine that the signal transmitted by sensors represents an actual intrusion. This could be an independent system or methods within a single system to verify that it is operating properly and an alarm condition does exist.

The critical considerations in the design of a detection and assessment system are probability of detection, false alarm rate, and vulnerability to defeat. Obviously, the probability of detection should be maximized and the false alarm rate and vulnerability to defeat should be minimized. When such a system is being designed for installation in an historic structure, the designer must also minimize disturbance of historic fabric and the effect on the historic appearance of the structure.

Communication systems must be appropriate to the response force that is available. The park currently employs night watchmen whose tours of duty include approximately 90 percent of the hours when regular park staff is not present. A system could be designed to communicate in different modes--for example, a local alarm to counteract daytime pilferage and a general systemwide alarm for nighttime intrusions. The nighttime alarm could be arranged to automatically notify the superintendent (or other park staff), the state police, and the night watchman. There is no private response company closer than Albany--a minimum of 30 minutes away. If the state police have a policy of not responding to recorded alarm messages, then the night watchman should make that call his first priority. Once the house is refurnished, the night staff should be increased to provide 100 percent coverage. A night watchman can make important contributions to all four elements of an effective intrusion protection system: detection and assessment, communication, delay, and response. In light of this fact, careful consideration should be given to the possibility of foregoing an elaborate intrusion detection system. The use of a full-time night watchman could be augmented by the installation of a simple key-clock system.

This section on intrusion protection systems is intended only as an introduction to the basic principles of such systems. The design of such a system for Lindenwald is too complex for adequate presentation in this document; therefore, a separate preliminary design for intrusion protection systems will be prepared.

These measurements should be used for the final drawings of the Lightning Rod Rods in the NSR.

17 ARTILLERY ROAD
 National Historic Site
 Box 545
 Kinderhook, N.Y. 12106
 518-758-9689
 Richard A. Lusardi
 Chief of Maintenance
 14 Mar 79

A.M.G.

Rod

Material: Metal - Possibly Iron

Twisted spiral

3/4" Overall Width

5/16" Exposure to outside Dia.

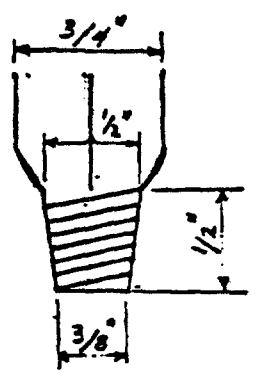
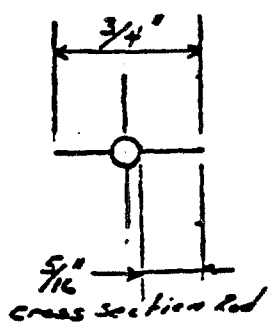

Screw Tapper at Base of Rod

7 Threads to 1/2"

Overall length of Rod is 118 1/2" (119") not including copper tip.

Tip

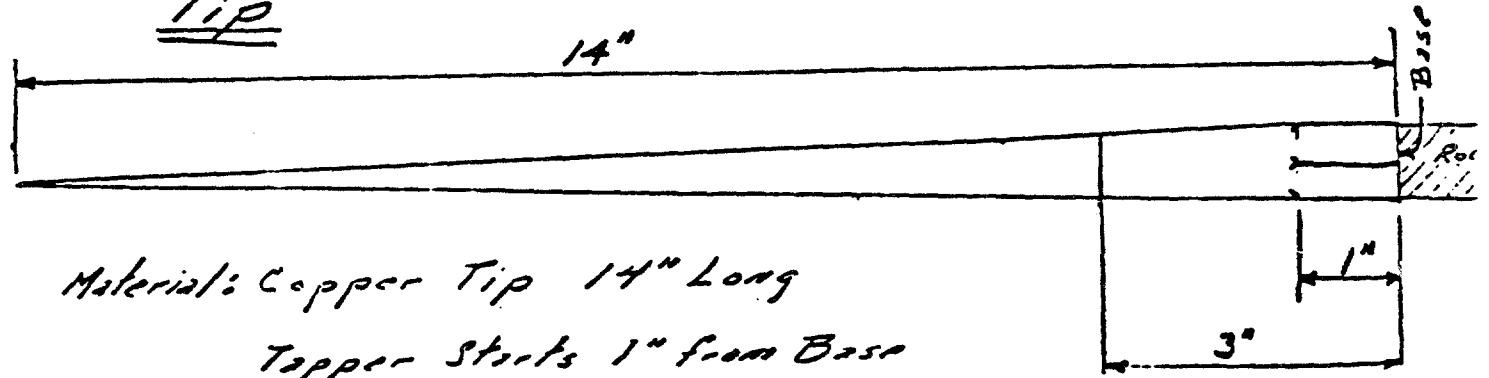

Material: Copper Tip 14" Long

Tapper Starts 1" from Base

Base is hexagon in shape

A Line appears around tip 3" from base

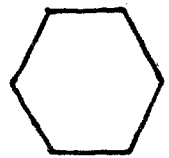

Lightning Rod

National Historic Site
Box 545
Wanderhook, N.Y. 12106
518-758-9689
Richard A. Lusardi
Chief of Maintenance
14 Mar 79

Connector

Octagon in Shape

1 1/4" Long

1/2" Inside Dia

Material: Metal - Possibly Iron

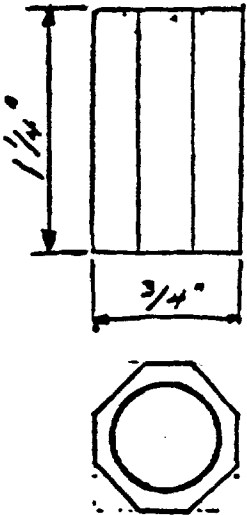

Insulator

Material: Glass - Green Color
Seams on Each side of Glass
Little bubbles on inside of Glass

2" Outside Dia.

1" Inside Dia

1 1/2" High

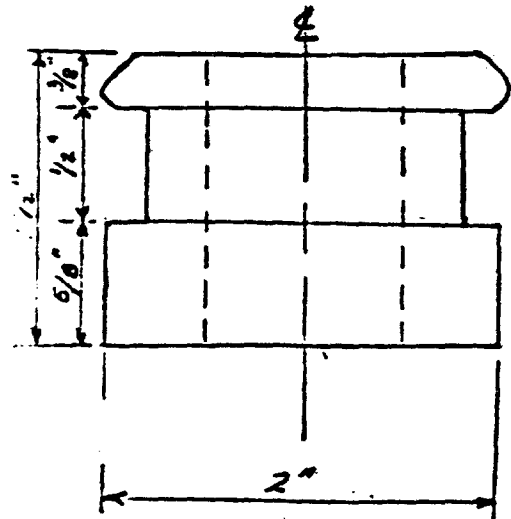

V. Statement of Restoration Philosophy

The preservation treatment to be applied to the Martin Van Buren house, Lindenwald, will be guided by the following internationally accepted maxims adopted in 1936 by the Advisory Board on National Parks, Historic Sites, Buildings, and Monuments (now the National Park System Advisory Board):

Better preserve than repair, better repair than restore, better restore than reconstruct.

It is ordinarily better to retain genuine old work of several periods, rather than arbitrarily to "restore" the whole, by new work, to its aspect at a single period.

The restoration of a historic structure to reflect an earlier period of its existence usually involves the impairment or destruction of some of its original fabric and a degree of conjecture in the replacement of missing fabric. Alterations to a structure are often of historical or architectural value in themselves and convey a desirable sense of evolution over time. No matter how well conceived and executed, a restoration will be an artificial modern interpretation of the past rather than an authentic survival from it. Accordingly, the preservation of a historic structure in its existing form shall always be given first consideration (NPS 1978, 15-16).

In addition, preservation work will reflect the following guidelines:

For purposes of preservation treatment, the National Park Service recognizes three classes of cultural resources: historic sites, historic structures, and historic objects (which differ from structures in being generally movable). Perpetuation of these resources will be accomplished by one or more of the following methods: preservation, restoration, or reconstruction.

Preservation - involves the application of measures to sustain the existing terrain and vegetative cover of a site and the existing form, integrity, and material of an object or structure. It includes initial stabilization work, where necessary, as well as ongoing maintenance.

Restoration - is the process of recovering the general historic appearance of a site or the form and details of an object or structure by the removal of incompatible natural or human-caused accretions and the replacement of missing elements as appropriate. For structures, restoration may be for exteriors and interiors and may be partial or complete.

Reconstruction - involves the accurate reproduction of an object or structure, in whole or in part.

All forms of treatment may be carried out in an area as applicable. Significance of the resource, its condition, its interpretive value, and the cost of treatment are all factors that must be weighed in determining the appropriate treatment (NPS 1978, 13).

These guidelines must be modified and applied selectively to specific aspects of the resource in order to achieve the purpose set forth in the 1970 master plan--"to interpret the life and public service of Martin Van Buren at the only remaining site that is personally related to the eighth President of the United States."

Martin Van Buren's association with this site certainly dates back as far as the first years of the 19th century when he was a friend of William Van Ness, son of the owner and builder of this house, Peter Van Ness. Van Buren bought the property on April 1, 1839, and it served as his principal residence from the time of his retirement from the presidency on March 3, 1841, to his death on July 24, 1862 (NPS, Platt 1982, 101).

Since Van Buren's connection with the site is its primary reason for inclusion in the national park system, we are obligated to present it to the public as Van Buren knew it and, more importantly, as his occupancy, use, and enjoyment of the resource are exhibited in the changes that he initiated.

When historic fabric has deteriorated or caused deterioration of other fabric due to deficiencies in the original design, those deficiencies should be corrected or mitigated in the course of the restoration work. If such corrections or mitigations cannot be accomplished without an intrusion on the historic appearance that would be noticed by the general public, then the measures should not be undertaken and the park chief of maintenance should be alerted to the required special maintenance procedures.

All physical changes to the building in the course of the work should be clearly identified as new by marking the material with the date of installation. Concealed work should be done with modern materials (not reused unless historic material is being returned to its historic position) and date-marked in a conspicuous area. Exposed materials should be chosen to approximate historic appearance and performance and date-marked in an inconspicuous location. The most effective construction techniques should be employed regardless of the history of the technique. Untried or insufficiently tested modern techniques and materials should not be employed. If two or more techniques are equally effective and equally consistent with the restoration philosophy, the most modern techniques should be employed so that future preservationists will have additional information for dating the work. Whenever possible, construction techniques should be reversible without impairment of the historic fabric.

VI. Analytical Data

A. X-ray Investigation

X-rays were taken by E. Blaine Cliver and Marsha L. Fader on May 3, 1979. The X-ray camera used was a Bendix-ray portable with Polaroid sheet radiographic film. The reproductions presented at the end of this section are reduced approximately 20 percent from actual size.

The nail evidence exposed through X-ray investigation supports the theory of pre-Van Buren alterations. There are four nail types, possibly representing four periods of change.

One of the nail types appears to have a handwrought shank, a handmade head (unlike the 1797 faceted head), and a very short taper on the upper end. This nail type is commonly found in the previous chair rail location in a nonfunctioning position, often bent or broken.

There are three nail types. The earliest type is in the north door casing (D203) of room 208. The head is irregular and the upper end taper is short. The later cut nail has an early machine-made head and a longer taper at the upper end. This later cut nail is in the pilaster construction forming the arch between rooms 206 and 207. The datable cut nail is from the ca. 1849 first-floor stair opening casing. This nail is entirely machine made, with a swelled head and no taper at its upper end.

From the various nail types found through X-ray investigation, it can be concluded that alterations were made within twenty years after the 1797 date of construction. The chair rail nails are the earliest evidence of change, though exactly what change took place may not be readily understood. The relocation of the north wall door 203 in room 208 represents a subsequent change, and the pilaster and arch construction provides the evidence for an even later alteration. William P. Van Ness appears to be the author of these changes, having been in residence until 1824.

1. Room 105

An X-ray was taken through the door 130 casing for the purpose of establishing datable details. All nails are modern type cut finish nails. Some nails show a more slender profile, others have larger swelled heads. This door casing frames the entrance to the stairs installed by Martin Van Buren in 1841 and refashioned by Upjohn in 1849 (see MAVA 01 X001 at the end of this section).

2. Room 106

Several X-rays were taken to provide 1797 construction details. Door 136 casing (between rooms 105 and 106; see MAVA 01 X002) shows three types of nails and one screw appearing to date from the earliest construction period. The shaft of a large handwrought nail is visible, as is the shaft of a blunt end screw. Two types of small nails include an L-head nail (possibly wrought) with what appears to be a hand-hammered head and a lath nail with what may be interpreted as a two-facet handmade head.

The second X-ray (MAVA 01 X003) taken through the south pilaster of the west wall arch provides additional evidence to support the 1797 dating of architectural elements. The nails are handwrought with two-facet handmade head.

3. Room 206/207

Four X-rays were taken of the second-floor arch pilasters between rooms 206 and 207 to investigate their period of construction. The north and south pilasters show large common nails with cut shanks and possibly early machine-made heads. The shank is tapered at the upper end. The lath nails that are visible all have the familiar two-facet handmade head of the 1797 period. Very small L-shaped finish nails are visible as fasteners of the wood tracery (see MAV A 01 X004-007).

Two X-rays were taken at the base of the south pilaster. A multitude of nail types are visible including lath nails with two-facet handmade heads, various lengths of cut finish nails, and small L-head nails (see MAV A 01 X008-009).

4. Room 207

X-rays taken at the north and south door jambs (D202) show probable split lath, lath nails with two-facet handmade heads, and large handwrought nails (on the north only) and short taper at the upper end. The large handwrought nails are in the previous chair rail area (see MAV A 01 X010-012).

5. Room 208

X-rays taken in the area of the north wall "ghost" showed a more evenly cut lath that may be sawn lath. This lath is in the area of the previous chair rail. The lath nails are not readily distinguishable. In the areas of split lath, the two-facet handmade head is visible. The large nails in the chair rail area are the same as those found in room 207--a handwrought nail with a short taper at the upper end (see MAV A 01 X013-014).

The north wall door jamb (D203) shows several very large cut nails with heads and a short taper at the upper end (MAVA 01 X015-016). There are also lath nails visible with two-facet handmade heads. This evidence suggests that the casing (presumed to be from the 1797 period from comparative stylistic evidence) was moved to its present location.

6. Room 209

Two X-rays were taken at the north jamb of door 216. Lath nails with two-facet handmade heads are visible, together with a wire nail and large modern-type cut nails with very regular machine made heads.

The X-ray taken at the floor level shows the wood pin securing a stud tenon to the plate. This information supports the existing physical evidence of change in the location of the door opening (see MAV A 01 X018-019).



MAVA 01 X001
Room 105, south wall, east jamb of door 130, looking south 36" above the floor.

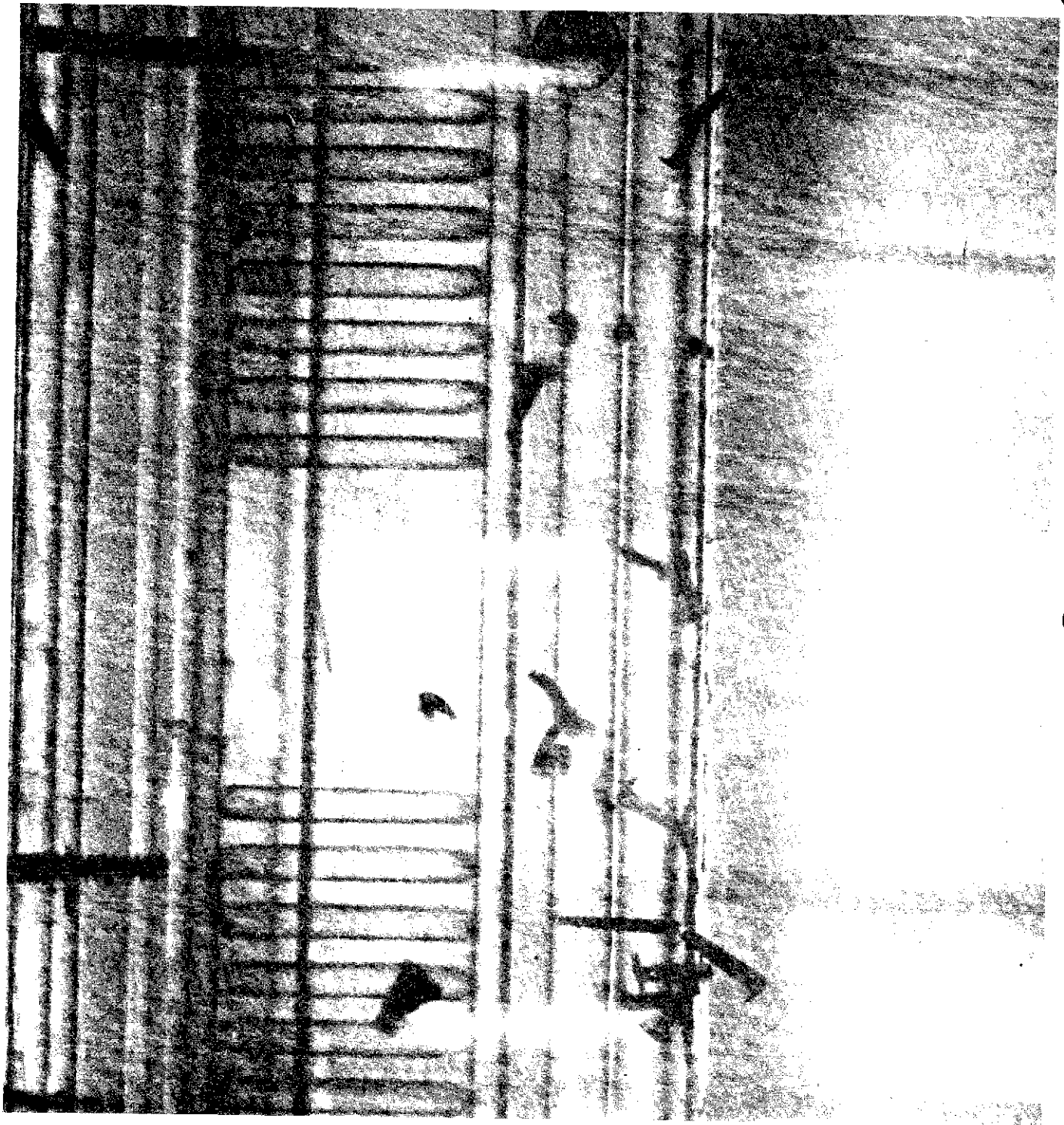

MAVA 01 X002
Room 106, door 136, east jamb, looking north 3'4" above the floor.



MAVA 01 X003
Room 106, west wall, looking west 3'4" above the floor.

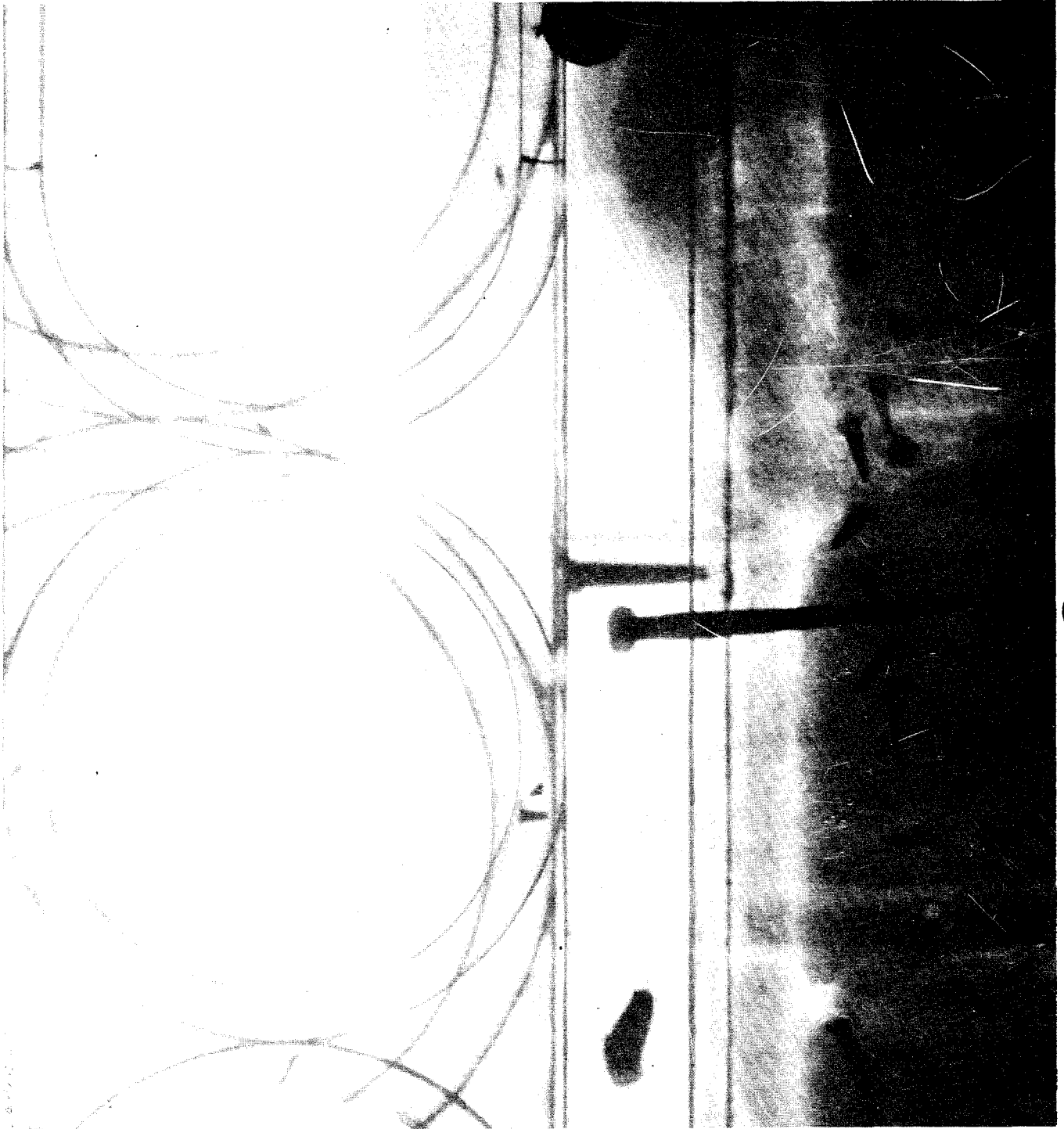

MAVA 01 X004
Room 206/207, door 218, north pilaster, looking west 2'10" above the floor.

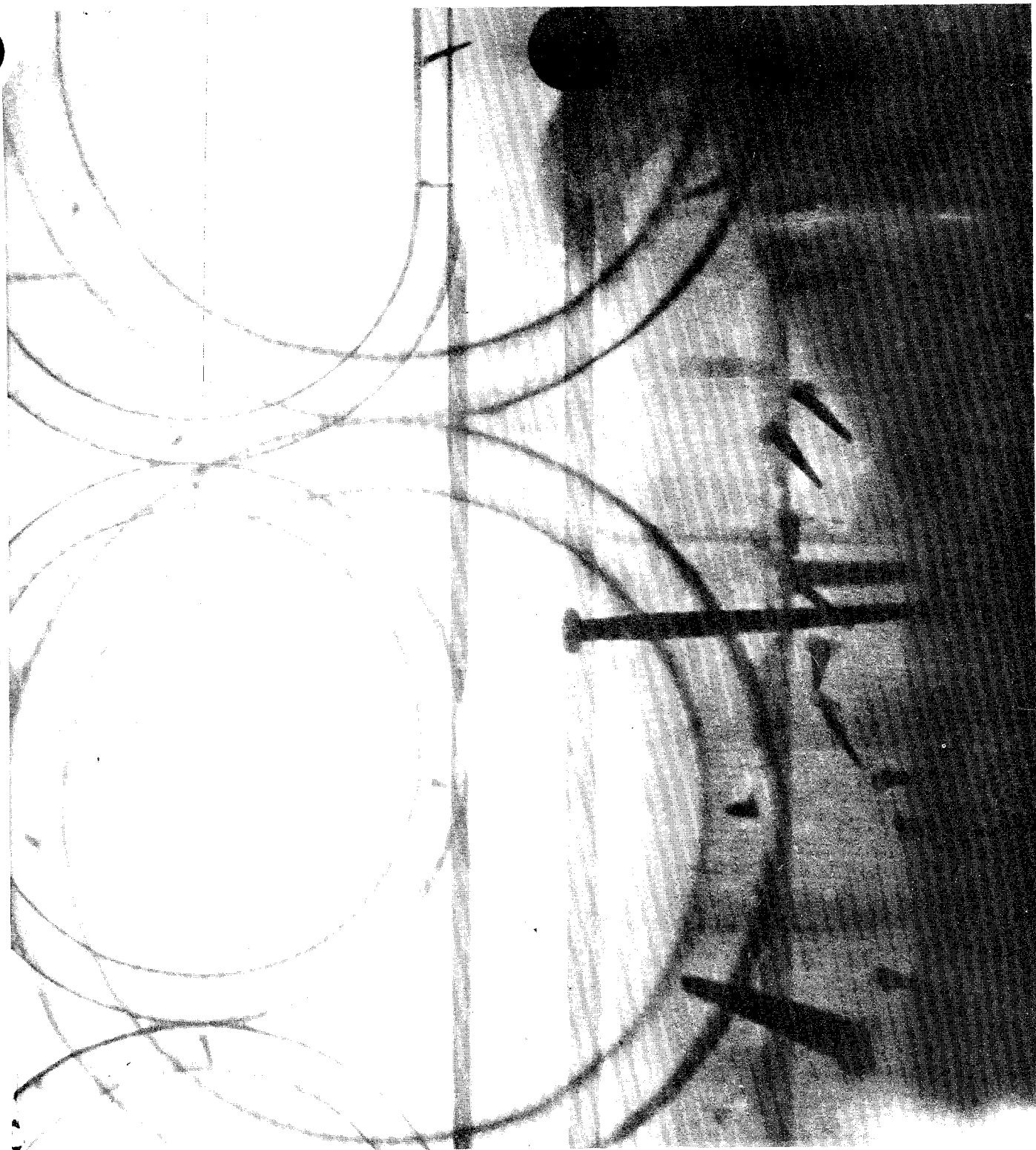

MAVA 01 X005
Room 206/207, door 218, north pilaster, looking west 2'10" above the floor.

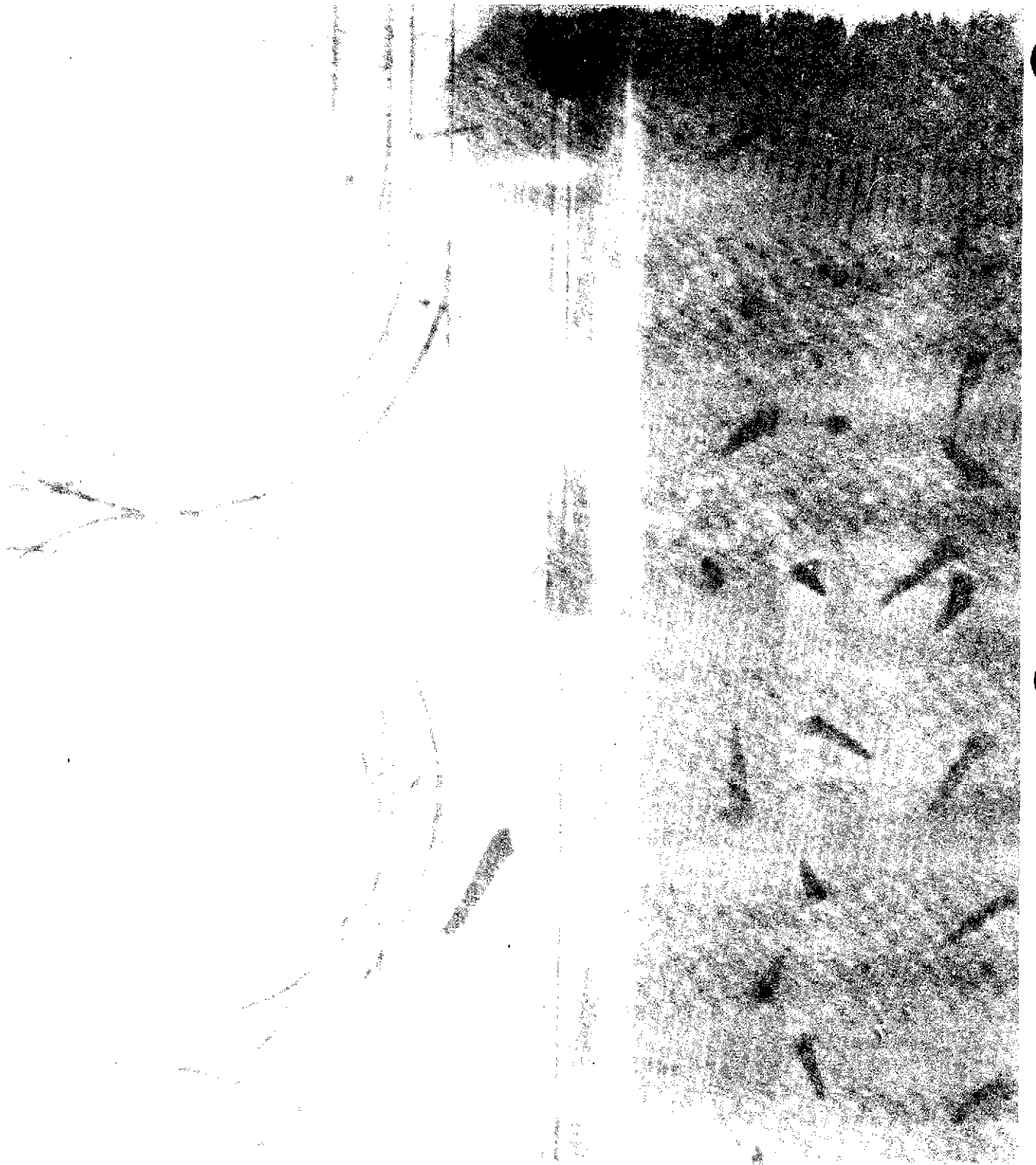

MAVA 01 X006
Room 206/207, door 218, south pilaster, looking east 2'10" above the floor.

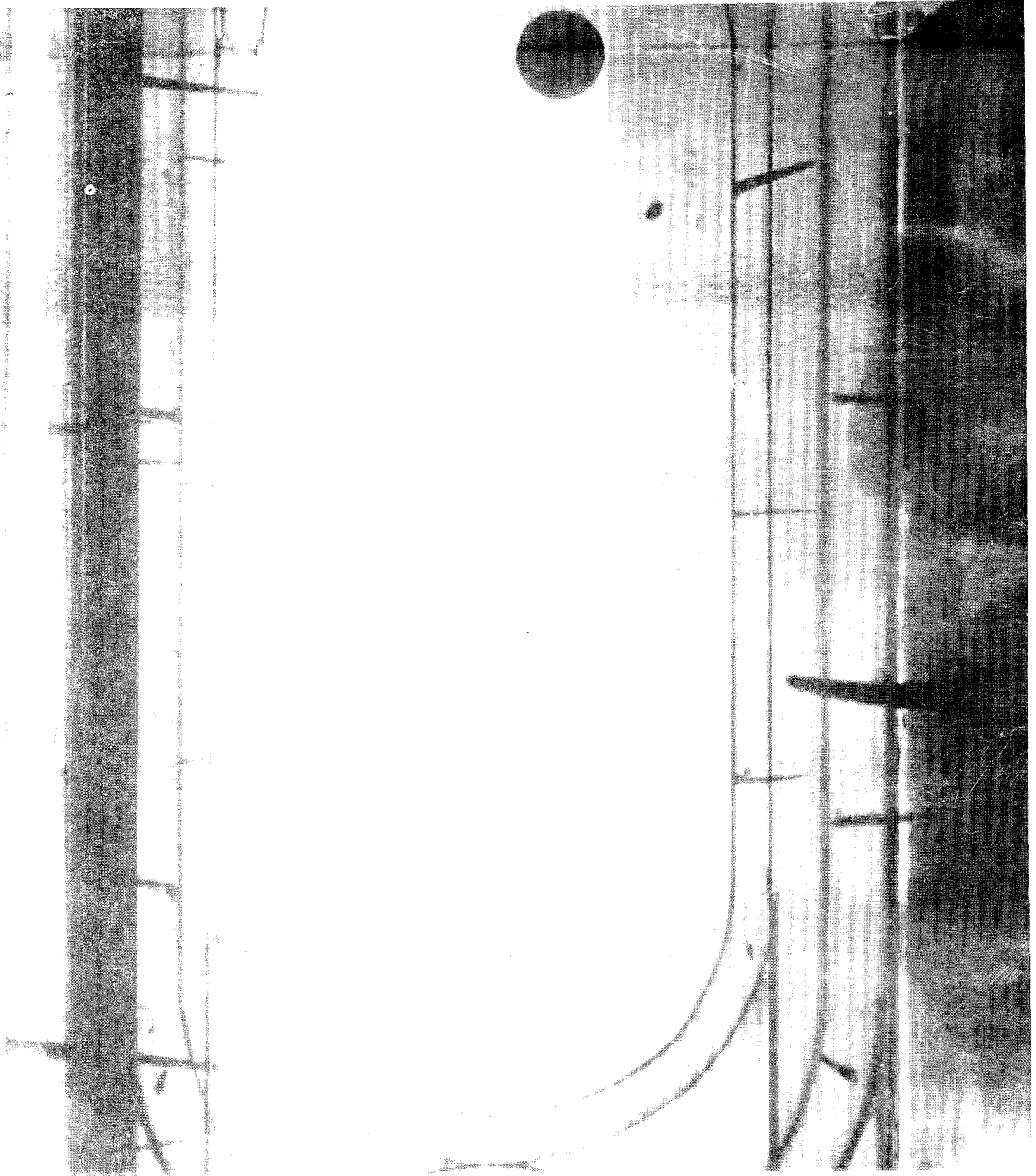

MAVA 01 X007
Room 206/207, door 218, south pilaster, looking east 2'10" above the floor.

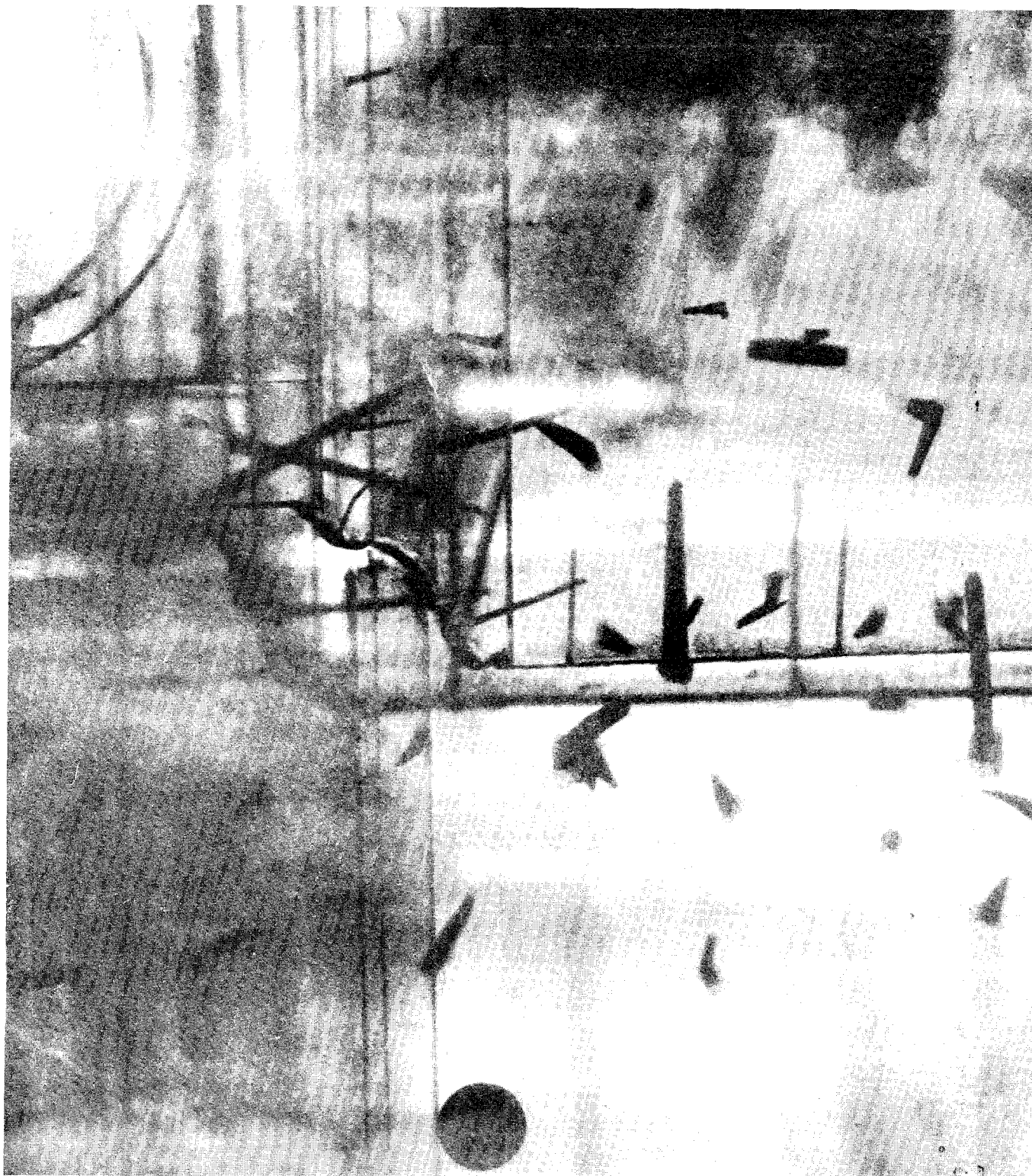

MAVA 01 X008
Room 206/207, door 218, south pilaster, looking west at floor level.

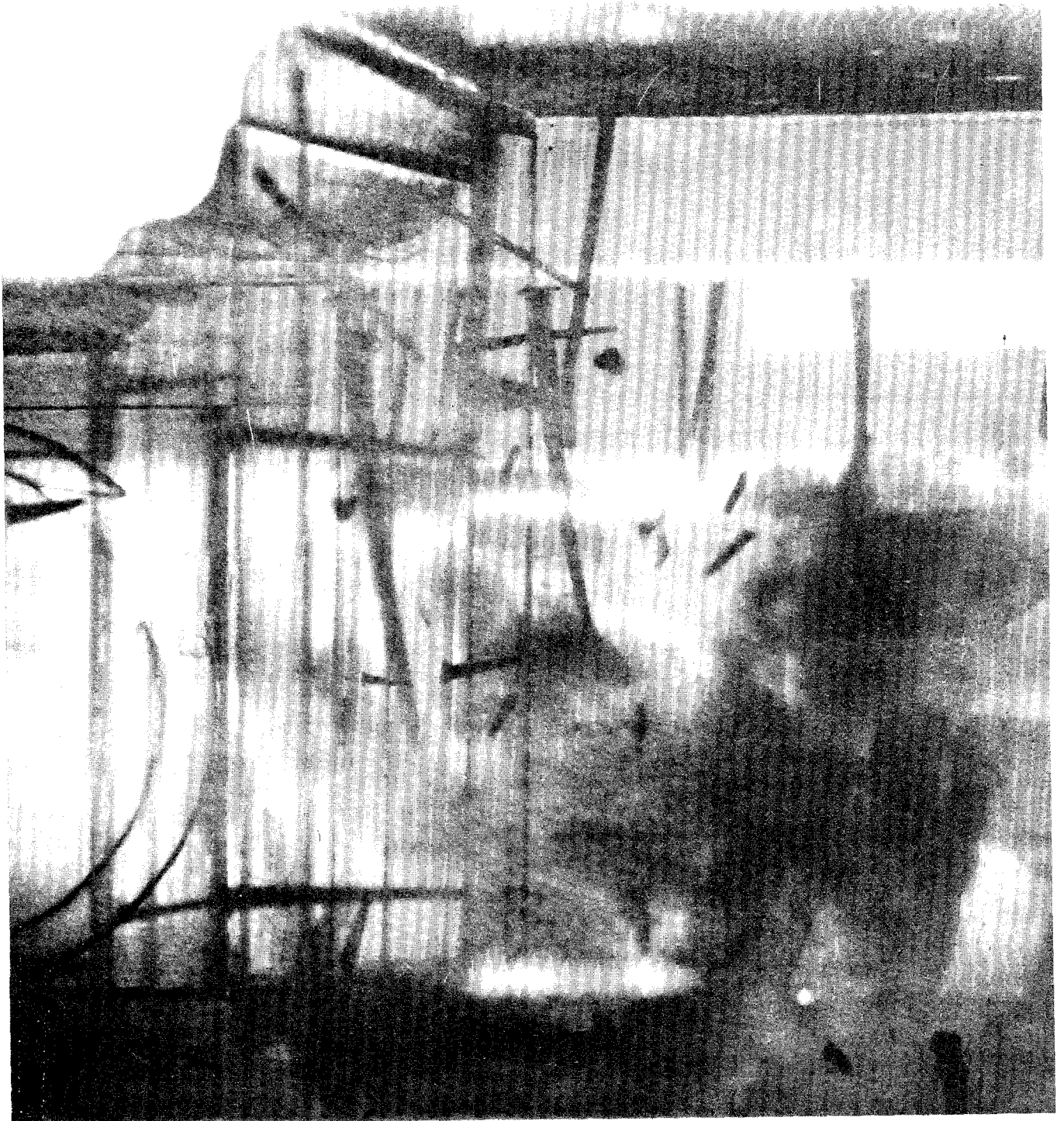

MAVA 01 X009
Room 206/207, door 218, south pilaster, looking west at floor level.



MAVA 01 X010
Room 207, door 202, north jamb, looking east 2'10" above the floor.

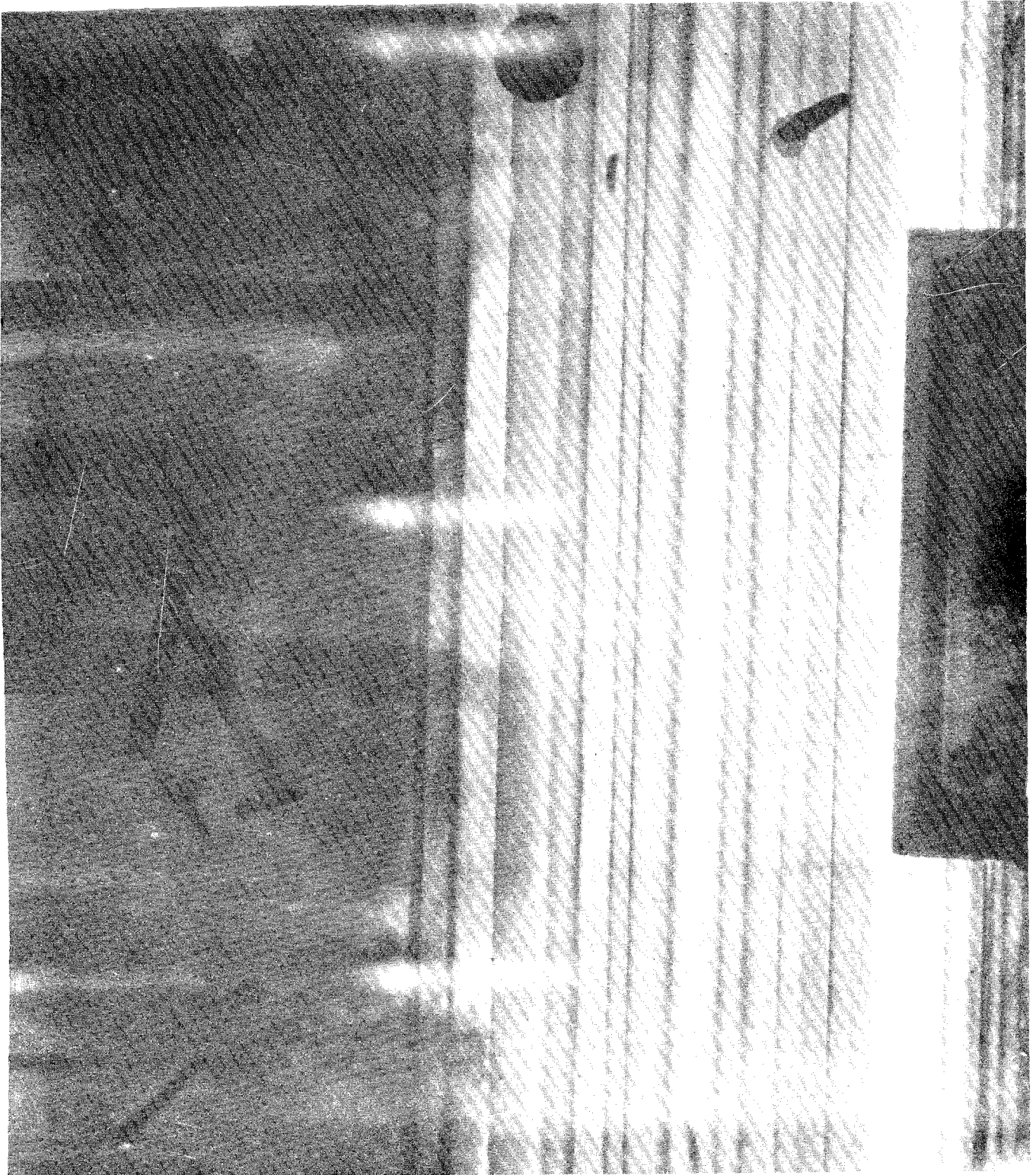

MAVA 01 X011
Room 207, door 202, north jamb, looking east 2'10" above the floor.



MAVA 01 X012
Room 207, door 202, south jamb, looking east 2'10" above the floor.



MAVA 01 X013

Room 208, north wall, ghost of door opening, looking north 2'10" above the floor.

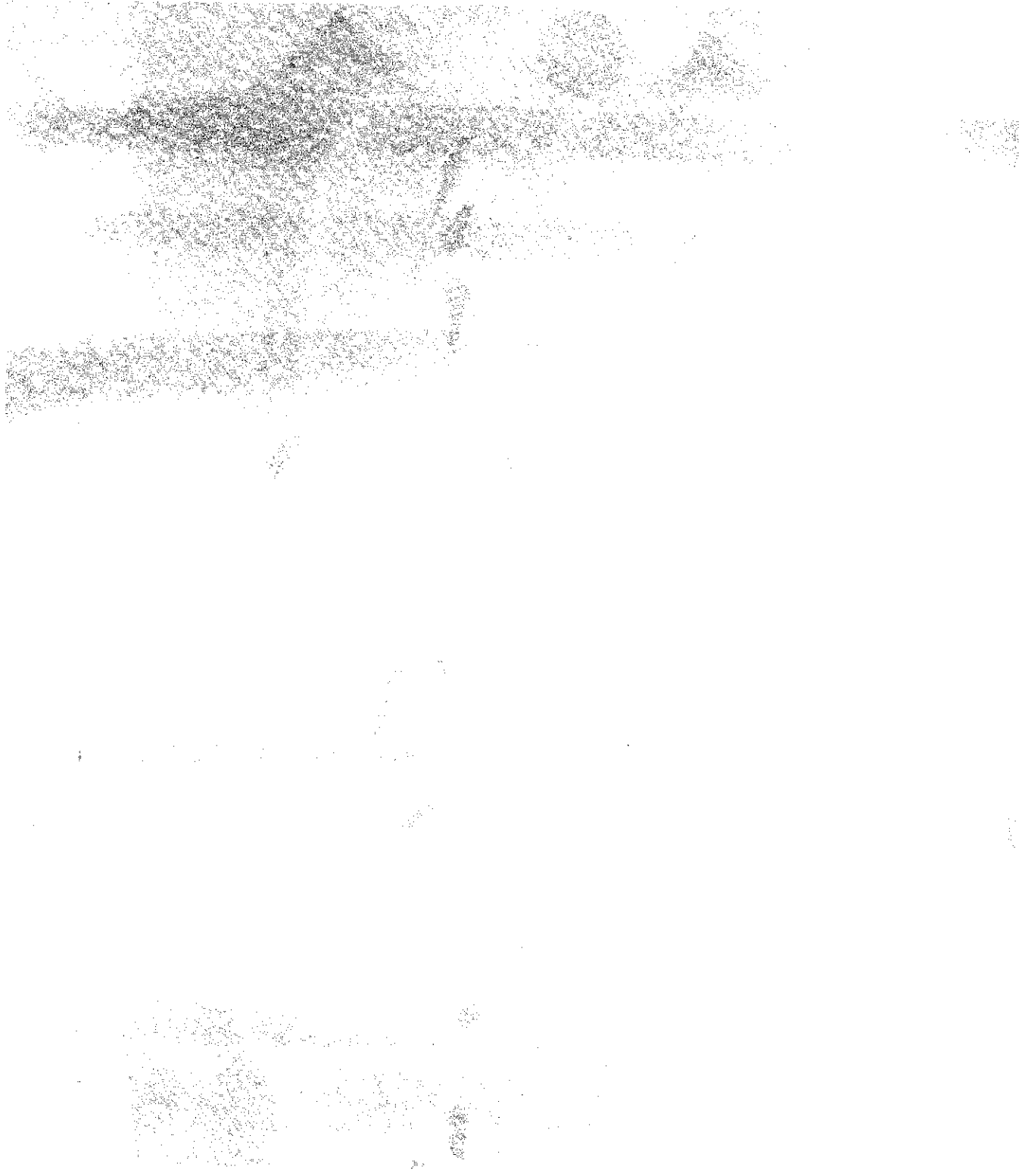

MAVA 01 X014

Room 208, north wall, ghost of door opening. Located about 3'0" above the floor.



MAVA 01 X015

Room 208, north wall, door 203, west jamb, looking north 2'10" above the floor.



MAVA 01 X106
Room 208, north wall, door 203, west jamb, looking north 2'10" above the floor.

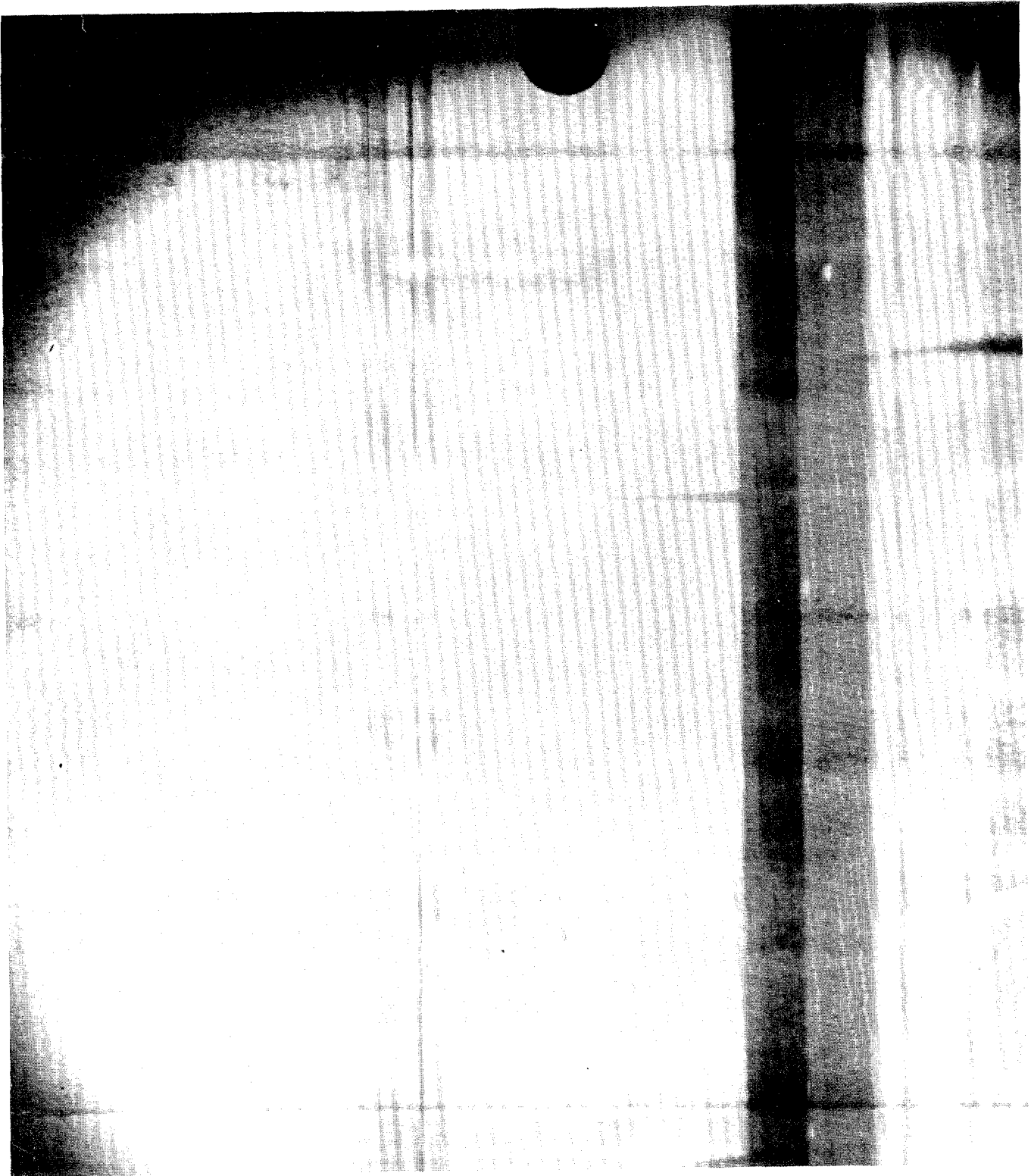

MAVA 01 X017
Room 208, east wall, north mullion, looking south.

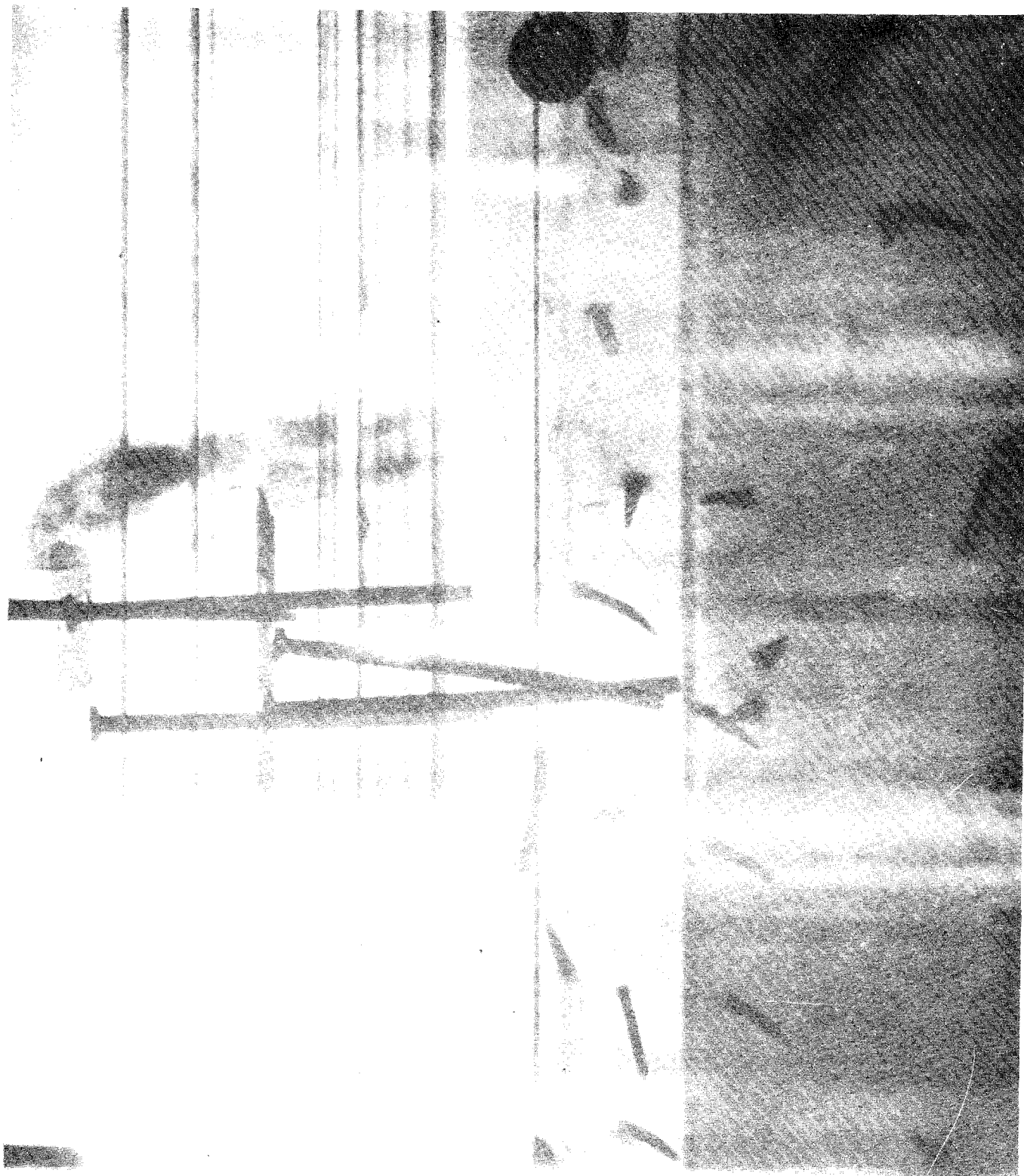

MAVA 01 X018
Room 209, west wall, door 216, north jamb, looking west 2'10" above the floor.

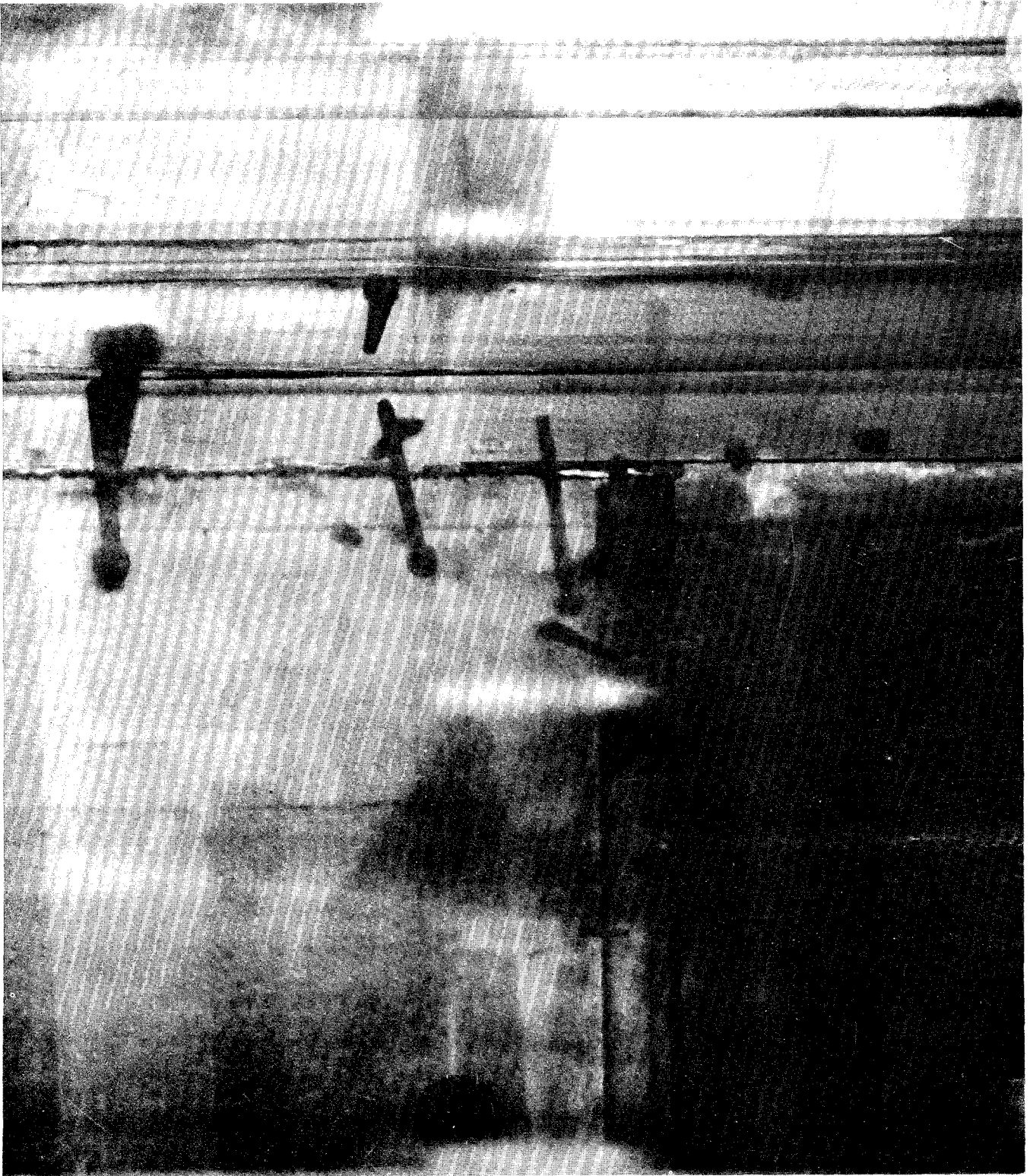

MAVA 01 X019
Room 209, west wall, door 216, north jamb, looking west at floor level.

B. Moldings Study

The molded contours given to projecting wood and plaster surfaces, such as window and door casings, baseboards, paneling, cornices, and muntins, have been measured, drawn, and organized into 11 groups. Moldings within each group are generally of the same type and date. Reproductions of moldings, although later in date, are shown with the original molding. The first six groups of moldings were found in the 1797 house; the remaining moldings were found primarily in the 1849 additions designed by Richard Upjohn. A single group includes muntins and window aprons from the 1797 and 1849 portions of the house. The eleven groups include

- window and door casings, first floor, 1797 house
- window and door casings, second floor, 1797 house
- door and shutter panels, 1797 house
- arch moldings, 1797 house
- cornices, 1797 house
- baseboards, 1797 house
- window and door casings, Upjohn, ca. 1849
- door, jamb, and shutter panels, Upjohn and post-Upjohn
- cornices, Upjohn, ca. 1849
- baseboards, Upjohn, ca. 1849
- window muntins and aprons

This analysis was undertaken to provide evidence of architectural change and historical development. The various moldings used in individual rooms in the house are described and analyzed in section IV.B. Thus, the descriptions and graphic presentations by group within this section are primarily for reference. All moldings are drawn at full scale. A description of the construction of complex moldings is included only in those cases where the moldings were exposed and accurately measured. Moldings not found within the 11 groups, such as the ca. 1849 skylight moldings, were not considered typical or significant to the group or to historical analysis. Other entire compositions of moldings, such as those found on door entablatures or mantelpieces, are represented by the inspection photographs mentioned under the individual room descriptions.

The following general statements were derived from this analysis:

The two primary periods of moldings are 1797 and 1849.

The changes made within the 1797 house by William P. Van Ness and Martin Van Buren (ca. 1840) were attempts at reproducing existing 1797 moldings.

The majority of extant moldings in the 1797 house are original to the house, including window and door casings, window shutters, doors, baseboards, cornices, and mantelpieces.

The 1797 moldings may be characterized as circular shapes of Classical Roman precedent with a vernacular interpretation. The more elaborate moldings are found in primary rooms 104, 105, and

106. The size of the architrave and the transition element varies on window and door casings.

The second-floor moldings on door and window casings in the 1797 house appear to have four variations on the original double architrave with cavetto molding dating ca. 1810 to post-1862.

Original 1797 elements in reused locations include the door 211 casing (matching D103, 104, and 107 casings), door 307 (matching 103 and 104), door 303 (matching 134 and 135), and door 305 (matching 101).

The ca. 1849 moldings designed by Richard Upjohn are large in overall composition, simple in the use of flat surfaces and circular shapes, with a predominant use of the cavetto, ovolo, fillet, and beak moldings. More elaborate moldings are in rooms 111, 113, 117, and 119. Upjohn moldings found within the 1797 house, although not attempts to reproduce 1797 work, are not the typical design found within his additions.

Window shutters of the original 1797 construction, found on the first and second floors of the main house, represent three types: rooms 104, 105, and 106 are more detailed than rooms 101 and 109, which have an ogee molding. The second-floor window shutters have an ovolo molding.

Post-1862 changes are supported by the lack of typical moldings, such as doors 106, 116, 121, 123, 127, 129, and 208.

C. Finishes Study

The finishes study for Lindenwald is divided into two parts--paint and wallpaper. Paint is the general term used to describe varnish, stain, whitewash, and calcimine, and standard oil- and water-based paint finishes.

The paint study contains a description of the procedures followed and a narrative describing the finishes of each of the interior rooms and the exterior painted surfaces of Lindenwald. Two sets of worksheets for paint samples that are representative of those analyzed in the study are included in appendix K. The first worksheets contain colored 3" by 5" photographs of the paint samples and their chromochronologies, with the reaction of the individual paint layers to selective chemical testing. The second sheets contain comments about the paint samples matched, a paint swatch of the color of the paint layer matched, the Munsell color notation for each color, the tristimulus values of this color, and the type of paint to be used for the restoration paint work.

The wallpaper study contains a description of the procedures followed, an outline identifying the wallpapers and fireboards found at Lindenwald (with a listing of historical references relating to the wallpapers), and recommendations for the conservation and reproduction of the wallpapers and fireboards. The worksheets for the ca. 1850 and other early wallpapers from Lindenwald are included in appendix L. The worksheets contain 3" by 5" black-and-white photographs of the wallpapers and their technical documentation.

Martin Van Buren NHS
Kinderhook, New York

Window and Door Casings
Not to Scale/First Floor, 1797 House

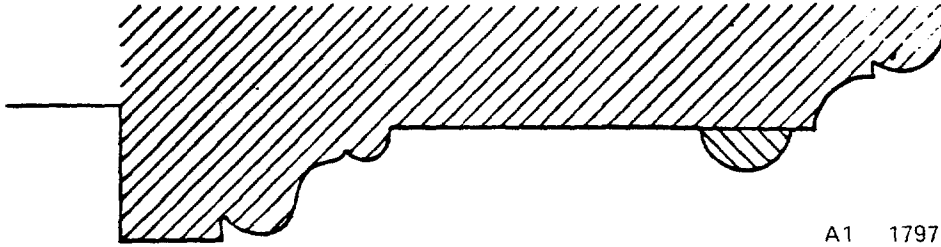

Variations occur in width of flat area.

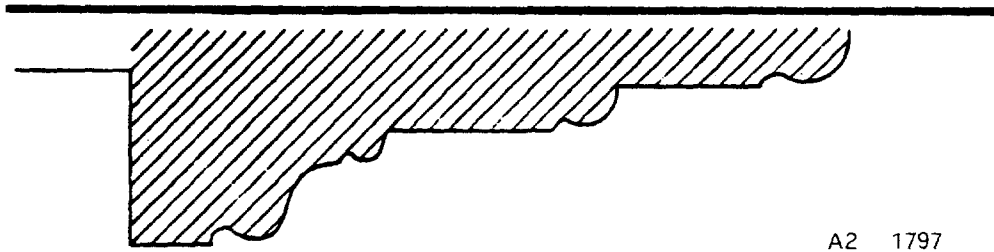
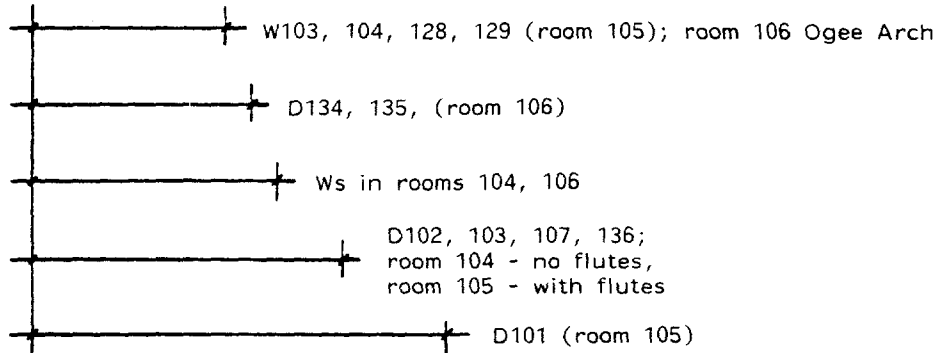

Location: D107 (room 101 only), D104, W109 and 110,
D137, D103 (room 102 only), D132, D134 (room 108 only),
D135 (room 107 only), W125, D211 (room 206 only), D307
(room 302 only).

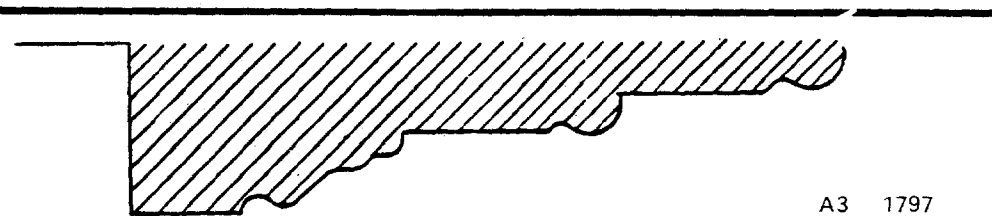

Location: D105, room 101.

Martin Van Buren NHS
Kinderhook, New York

Window and Door Casings
Not to Scale/Second Floor, 1797 House

Differences among the five types are based upon the cavetto profile, shape of bead, and size variations.

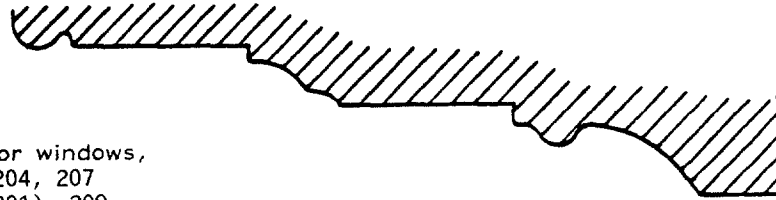

2nd floor windows,
D203, 204, 207
(room 201), 209,
210, 215

A4 1797

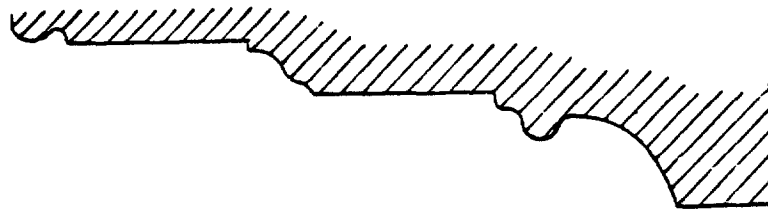

D202, 206

A5 ca. 1804-1824

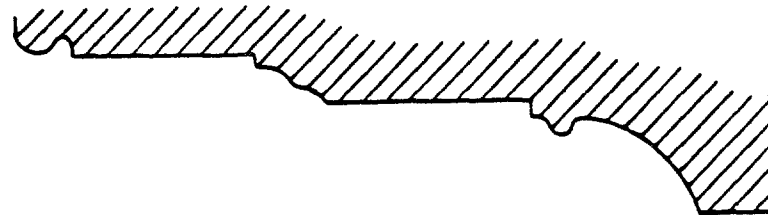

D201, 217

A6 ca. 1804-1824

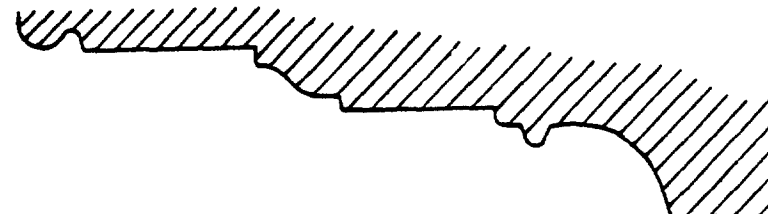

D216

A7 ca. 1804-1824

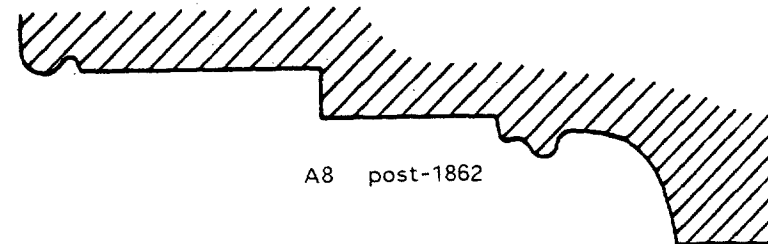

D205

A8 post-1862

Martin Van Buren NHS
Kinderhook, New York

Door and Shutter Panels
1797 House
Not to Scale

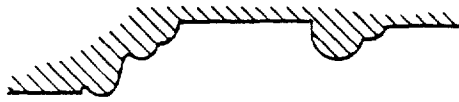

P1
D101, 305
1797



P2
D103 (room 102), 104
(room 102), 107, 307
(room 307) - 1797



P3
D103 (room 104), 104
(room 101), 307 (room
302) - 1797

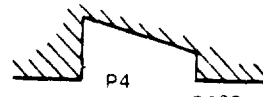
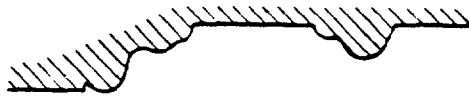

P4
Verso, D102, 132, 136

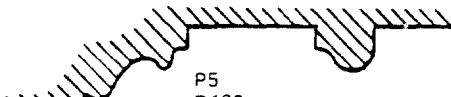

P5
D133
Reproduction, ca. 1840



P6
D105

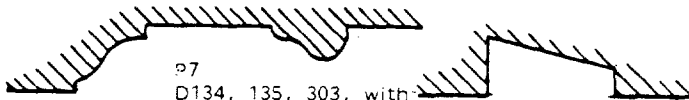

P7
D134, 135, 303, with
verso - 1797

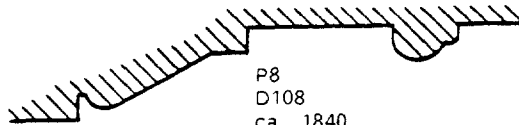

P8
D108
ca. 1840



P9
D201, 202, 203, 204, 207 (room 201), 209, 210 (room 206), 217,
with verso - 1797



P10
D206 with verso



P11
D216



P12
D304



P13
D301

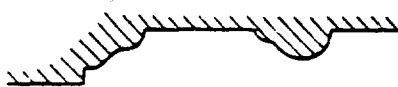

P14
Interior Shutter



P15
Interior Shutter



P16
Interior Shutter

Martin Van Buren NHS
Kinderhook, New York

Arch Moldings
Not to Scale/ 1797 House

W204, Palladian Window

1797

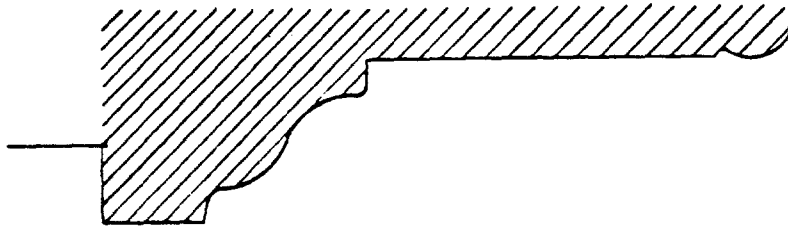

Room 106, Ogee Arch

1797

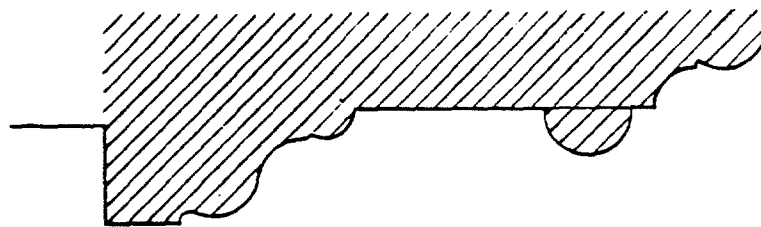

D218, Anse de Panier

ca. 1804-1824

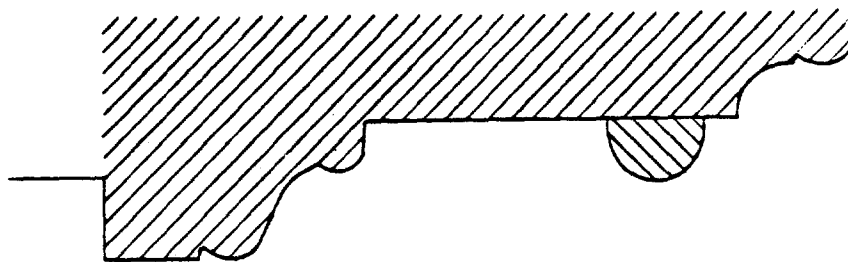

Martin Van Buren NHS
Kinderhook, New York

Cornices
1797 House
Not to Scale

All cornice types are dated 1797.
Not to Scale

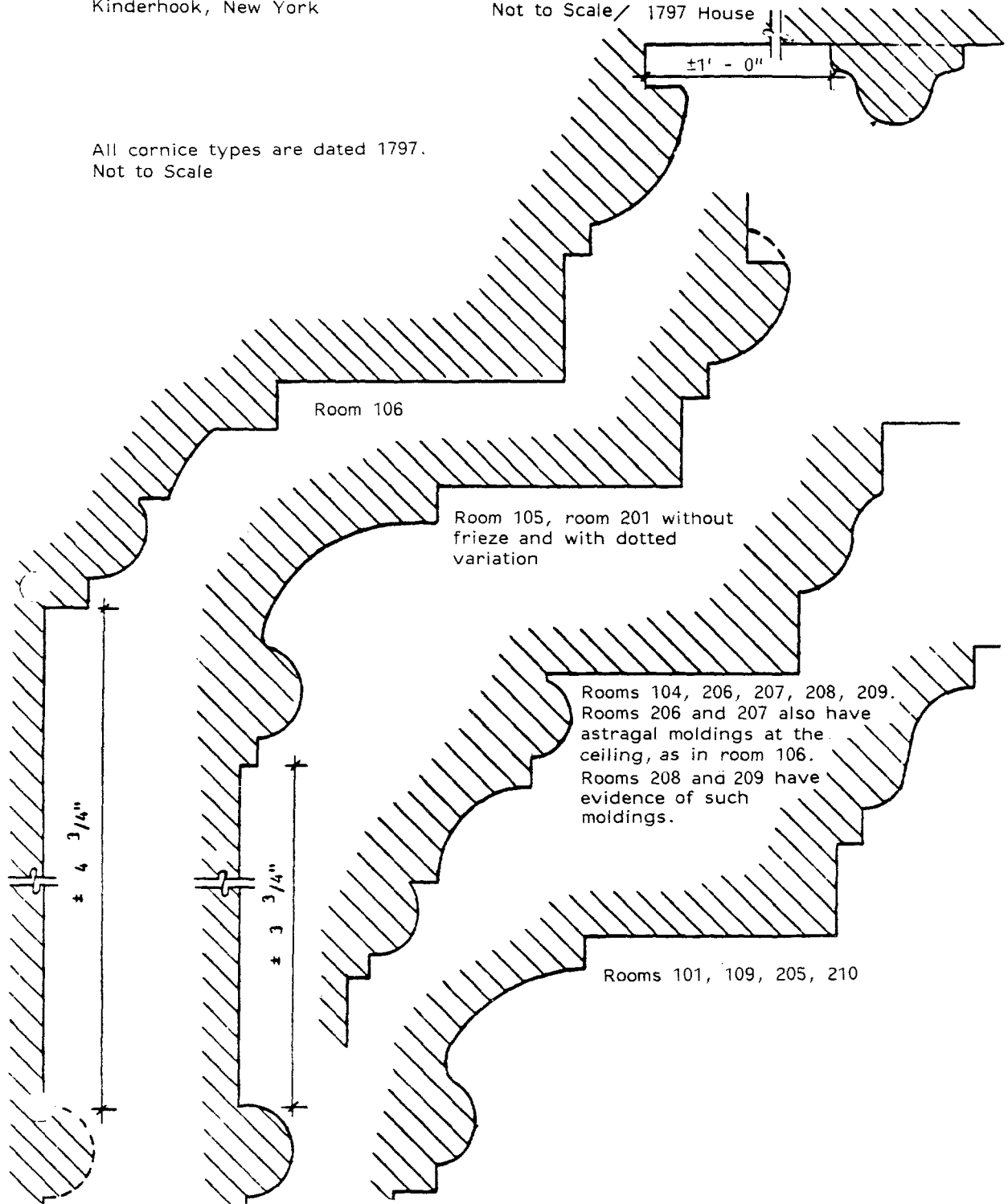

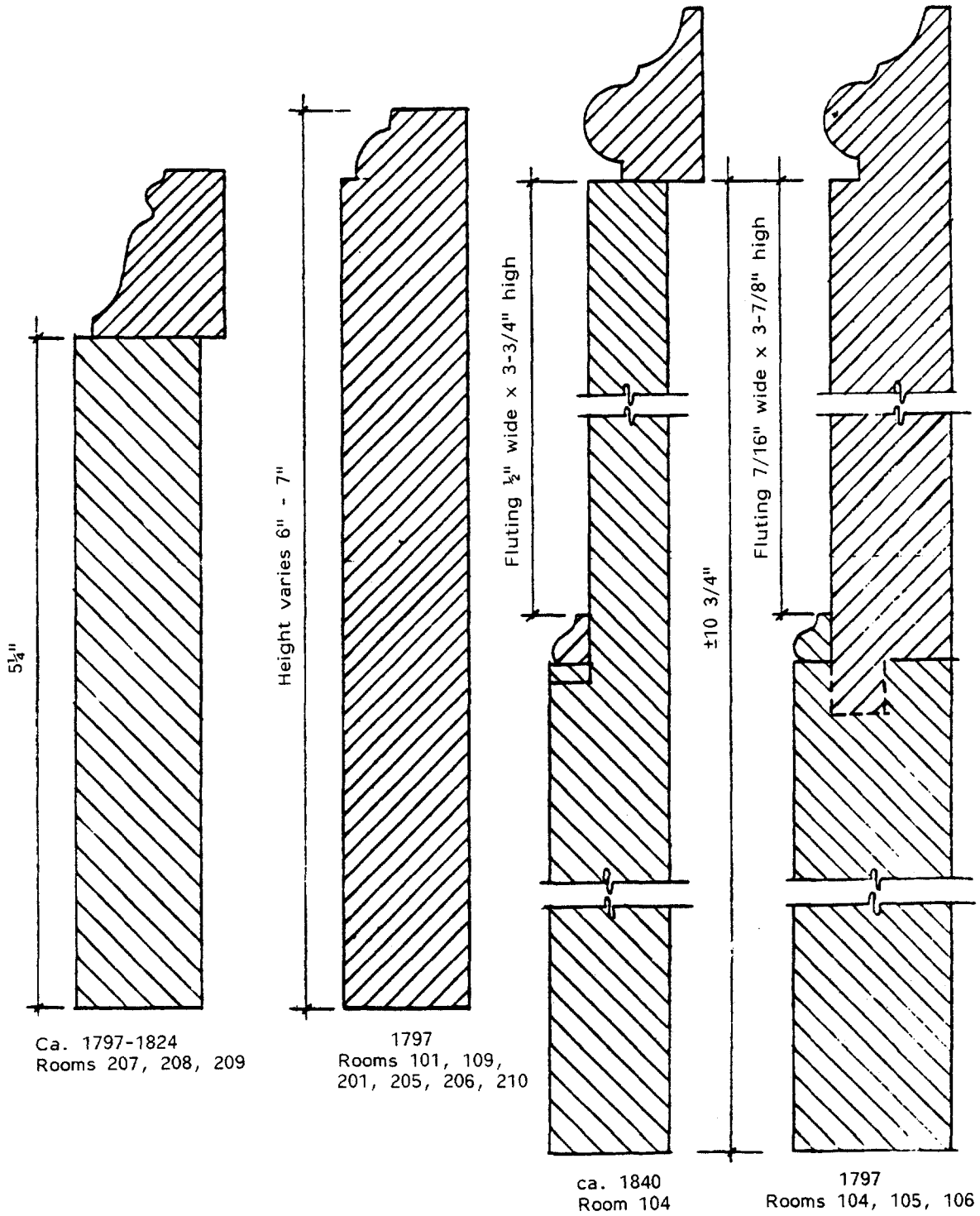

Martin Van Buren NHS
 Kinderhook, New York

Window and Door Casings
 Upjohn, ca. 1849
 Not to Scale

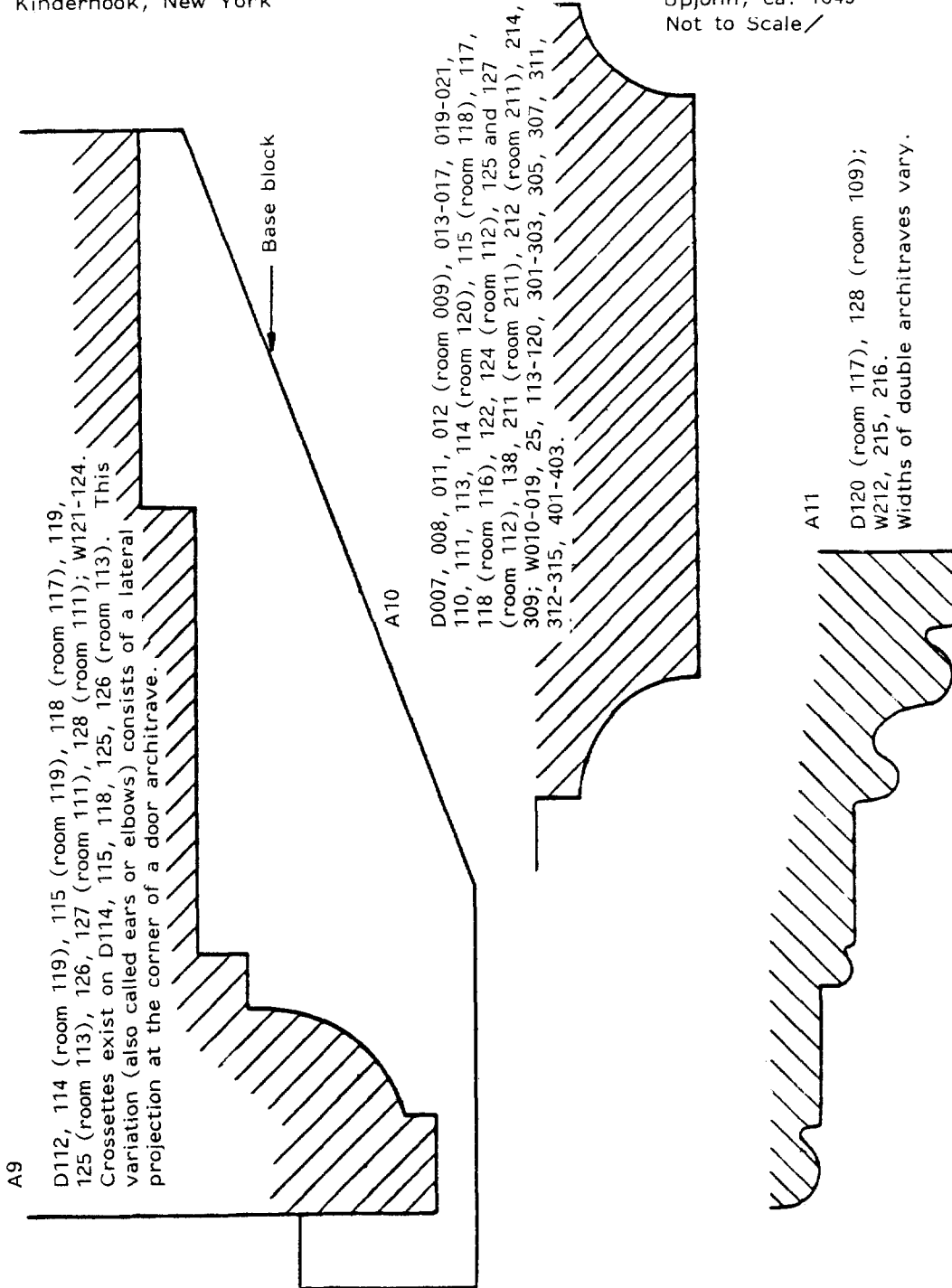

Martin Van Buren, NHS
Kinderhook, New York

Door, Jamb, and Shutter Panels
Upjohn and post-Upjohn
Not to Scale/

P17

Panels in skylight



Upjohn, ca. 1849

P18

D109, 112, 113, 115, 116, 123.
Jamb panels, D122, 125, 126,
128, 214, 309

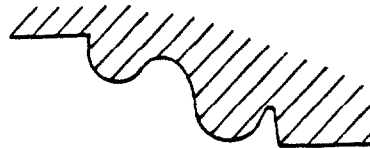

Upjohn, ca. 1849

P19

D110, 114, 117, 118, 119, 120
(with jamb panels), 122, 124-128,
211; interior shutters, W113, 116-124.

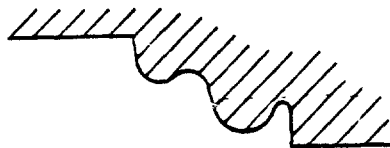

Upjohn, ca. 1849

P20

Interior shutters,
W111, 112



Upjohn, ca. 1849

P21

Jamb panels, D127



Post-Upjohn

P22

D121



ca. 1890

Martin Van Buren, NHS
Kinderhook, New York

Cornices
Upjohn, ca. 1849
Not to Scale

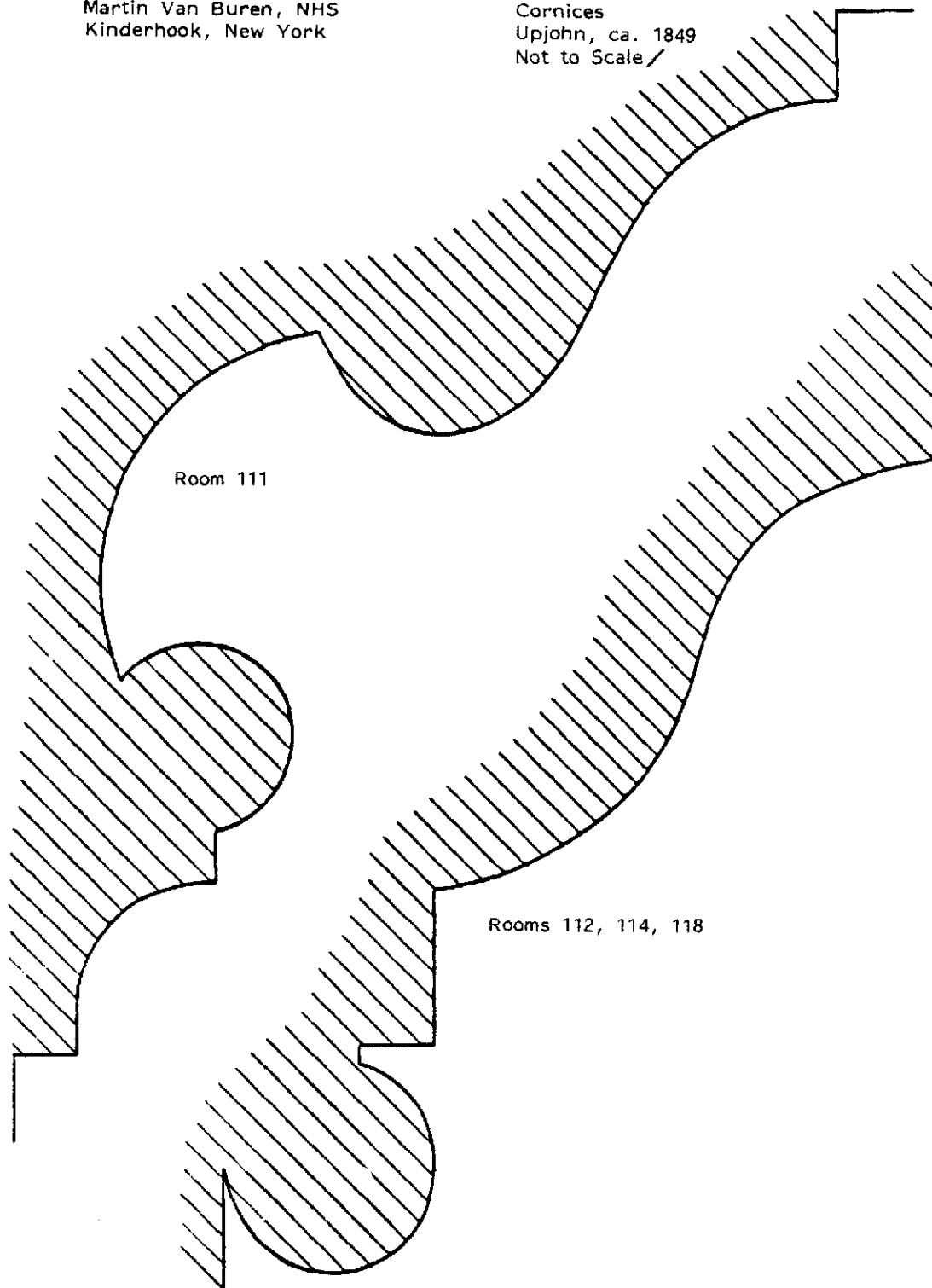

Martin Van Buren, NHS
Kinderhook, New York

Baseboards
Upjohn, ca. 1849
Not to Scale/

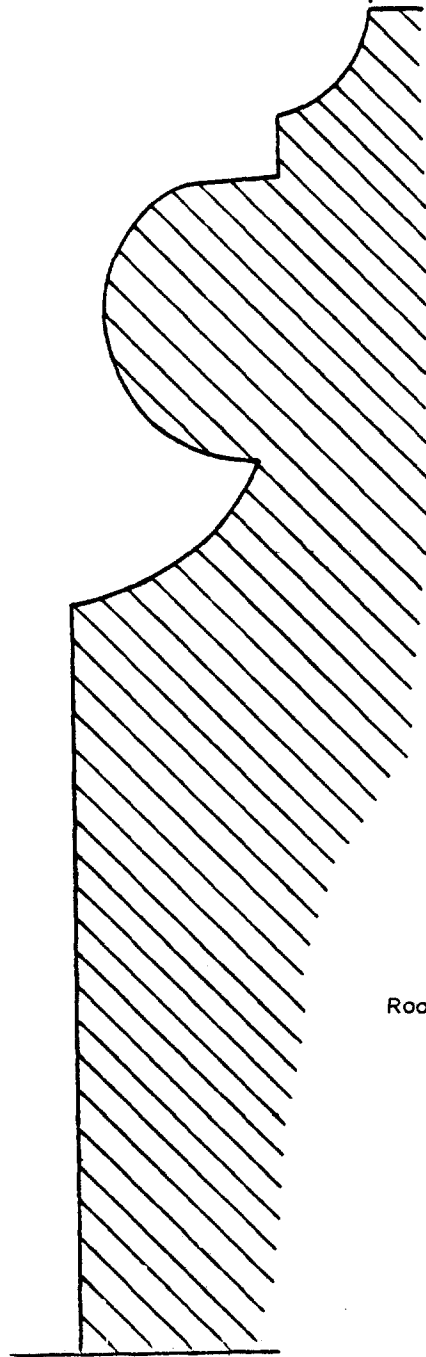

Rooms 111, 113, 117, 119

Martin Van Buren, NHS
Kinderhook, New York

Window Muntins and Aprons
Not to Scale/



M1
W204,
Palladian upper sash
1797



M2
D132



M3
1797 House, 6/6 sash
ca. 1840



M4
D202

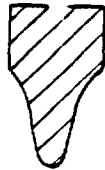

M5
ca. 1849

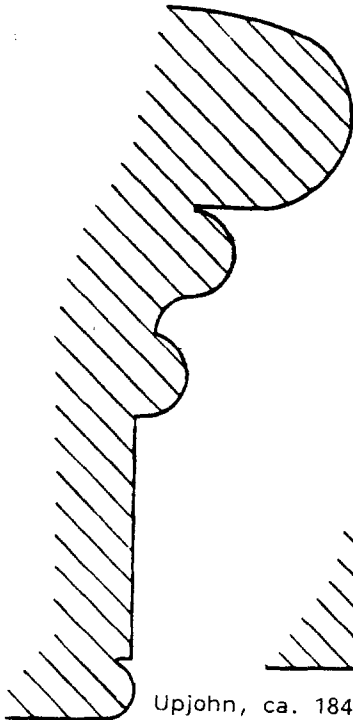

Upjohn, ca. 1849
W212

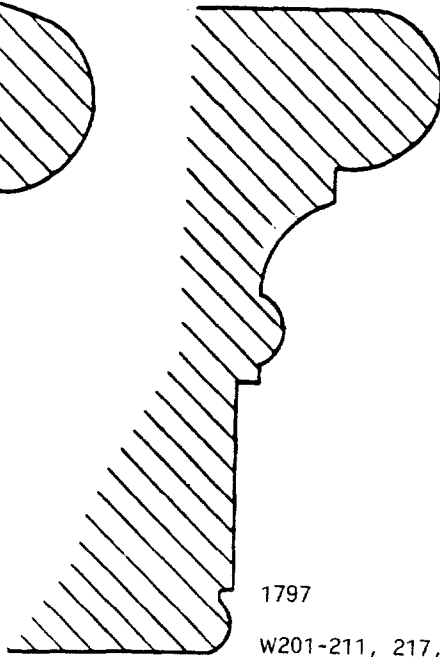

1797
W201-211, 217, 218

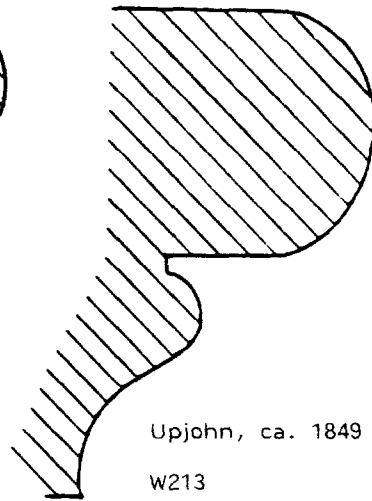

Upjohn, ca. 1849
W213

Finishes data derived from the paint and wallpaper studies was combined for the interior rooms. The ca. 1850 restoration period finishes for each room were identified, and a finishes schedule was drawn up to be used as the guide for all restoration work. This schedule identifies the finishes for the floors, woodwork, plaster walls, and plaster ceilings. Paint colors are identified by their Munsell color notations and have been matched to Benjamin Moore paints. Wallpapers are identified by their sample numbers.

Paint colors for the different exterior architectural elements of Lindenwald were organized chronologically into a chart identifying the six exterior paint schemes used on the house. The ca. 1850 restoration colors are identified by their Munsell color notations and have been matched to Benjamin Moore paints. The color scheme is also illustrated on colored drawings of the house.

1. Paint

A paint analysis was initiated during the summer of 1978 by the NAHPC as part of contract CX 1600-7-0056 (metal roof preservation and related repair). A paint study of the interior followed this work as part of preliminary HSR investigations. This study of selected rooms was used by the HSR team to scout out areas of change and to confirm and reject theories about the evolution of Lindenwald. The study presented here partakes of this work, expands on additional evidence, and provides specific recommendations for restoration paint colors.

a. Procedure

(1) Sampling

Paint samples were removed with an X-acto knife, placed in sealed coin envelopes, and identified by site, location, date, and person removing the sample. Information was obtained by scraping in situ to expose basic layering and fracturing characteristics.

(2) Laboratory Analysis

Preparation of Sample - Paint samples were examined with a 10x-70x binocular zoom microscope. Representative samples were cataloged and mounted in wax-filled petri dishes. Sample envelopes, petri dishes, and file cards all received consistent catalog numbers.

Recoding Chromochronologies - The paint layers of the representative samples were recorded on note cards.

Chemical Analysis - Sodium sulfide, hydrochloric acid, methylene chloride, and dimethylformamide were used to identify paint types. Samples were spot tested with the chemical and color, and physical changes noted.

Photography - Representative paint samples were photographed with a Nikon camera mounted on the microscope, using Kodak Ektachrome 160 Tungsten ET-135 film. Color slides and color prints were made of the paint samples.

Color Matching - Paint colors were matched with the microscope, using a blue filter and quartz halogen lamps for illumination to colors in the Munsell color system. When possible, the colors were also matched to Benjamin Moore and/or California Paint colors. The spectrophotometric curves of the Munsell colors were plotted on trichromatic computing forms, using a single beam spectrophotometer. From these curves, the tristimulus values for the colors were calculated.

(3) HSR Sample Forms

Paint samples that are representative of significant changes and chromochronologies, confirm the dating of specific elements, and otherwise help to clarify a narrative explanation were included as part of the "Historic Structure Report." The identification number in the upper right corner is the number used for retrieval of the samples in the NAHPC paint laboratory and is the same sample number referenced in the text. The results of chemical testing are included as coded symbols explained at the bottom of each sample form.

b. Interior Rooms

The narratives for the interior rooms at Lindenwald read from the basement up to the third floor. Descriptions of the rooms in the basement have been written up together because only two rooms, 005 and 006, were ever more than minimally finished. Descriptions of the attic rooms have also been combined because they were all finished alike ca. 1850. The narrative for the exterior of Lindenwald is organized chronologically.

Information found in these narratives has been limited to what was derived from scraping in situ, from microscopic examination, and from chemical testing. Synthesis and further analysis of this information, especially in areas of significant change, may be found under the more comprehensive description of an individual room in section IV.B. It includes historical documentation and information from other individual studies.

Readers of these narratives should be aware of several difficulties encountered in this paint study. The abundance of cream and white paint found in the samples made comparison of their layering sequences particularly difficult. Chemical spot-testing, principally the Na_2S , was used whenever possible to distinguish the number of layers and the relationships between layers. However, in many instances, identifying specific layers remained difficult. Another problem in counting and comparing paint layers was the fact that entire rooms were not repainted when different minor alterations were made. Rather, the paint used in the altered areas was matched to the existing paint in the room. Advanced weathering of the exterior painted surfaces also made identification of the number and colors of their paint layers difficult.

(1) Basement

The basement rooms of Lindenwald are finished in approximately four different ways. Rooms 001 and 015 have the least finish. Only the walls have been whitewashed, the ceilings have not been plastered, and the doors and windows have no casings. Room 014 houses

the brick privy and has no finish. In rooms 002, 002A, 003, 003A, and 004, the brick and stone walls are whitewashed, the ceilings are plastered and whitewashed, the doors and windows have no casings, and the floors are lime mortar. Rooms 007, 008, 009, 010, 011, 012, and 013 have plastered walls and whitewashed ceilings. (In room 012 the east wall, under the present plaster walls, is whitewashed. The stone of the north wall of room 112 also contains paint layers found on the exterior foundation of the ca. 1797 house.) Their doors and windows have molded wood casings painted with two creams and a brown that shows some traces of varnish, possibly a simple graining (see sample 720). The floors in these rooms are unfinished. Rooms 005 and 006 have plastered walls and ceilings, and the windows and doors have molded casings. The finishing schemes of these rooms are described below.

Room 005, the servants' dining room, has approximately six layers of paint on its woodwork--two creams, brown, white (two layers?), graining, and white (see sample 717). Paint samples reveal that most of the woodwork in this room dates to ca. 1849. The extant woodwork on the closet partition under the stairs appears to be later (see sample 758). The plaster walls in this room are wallpapered (001); the ceiling is whitewashed. An earlier wall (pre-1849) behind the present wall of the room is whitewashed. The brick of the chimney breast is also whitewashed.

Room 006, the kitchen, has about seven layers of paint on its woodwork--two tan, salmon, graining, white (two layers?), graining, and white (see samples 671, 718, 719). Paint samples confirmed that all of the woodwork in the room dates to ca. 1849. The only object sampled in the room that had a different sequence of paint layers was the wood brace onto which the force pump was mounted (see sample 678). As noted in section IV.C.3. this is a replacement pump installed after ca. 1862.

Paint samples taken from the lower cupboard on the north side of window 018 (see sample 679) contain the same early paint layers as the cupboard removed from Room 114 (see sample 503). This indicates that the cupboard in room 114 may have been one of the original cupboards used in room 006. Both of these cupboards were probably moved into room 112 when the kitchen was moved to this room at the end of the 19th century. Its location in room 112 accounts for the blue and green layers of paint on the cupboards (compare with sample 87 from room 112). When Campbell worked on the kitchen (room 112) ca. 1960, it appears that he moved part of the cupboard into room 114 and part of it back down to room 006. The part he moved into room 006 formed the base for some modern cupboards (see sample 680). These cupboards contain none of the early paint layers found on the other woodwork in the room.

The ceiling and walls in room 006 are plastered and whitewashed, and the floors are unfinished. Evidence of pre-1849 paint in this room was found above door 021, with an area of plaster above the door.

(2) Room 101

Most of the architectural woodwork dates from the same 1797 period. There are seven or eight possible paint schemes, including the earliest (ca. 1797) light yellow (see samples 115, 116). All elements for this period were light yellow, except the baseboards, which were a tan color (see sample 144).

The second and third paint schemes of cream were partially distinguishable from Van Buren's fourth scheme of cream by fracture evidence. The strongest evidence, however, comes from the west wall door 105 (sample 146), the closet backing at this door infill (sample 138), and the pegboard (sample 140). These elements have been dated ca. 1849 and have a cream base followed by the graining layers that appear on all other woodwork as approximately the sixth paint scheme. The jamb paneling at door 105 (sample 139), however, appears to have the same 1797 date as other room elements and implies that the opening would have been a passage into an attached space to the west (rear) of the original 1797 structure.

Door 106 (south end of the east wall) and its casing are 20th century additions, with four layers of paint (samples 019, 148).

The two layers of gray floor paint give no reaction to Na₂S testing, indicating that they are modern paints.

(3) Room 104

All elements of doors, windows, their casings and component parts, and most baseboards date from the same period of the original 1797 date of construction. Polychromy of baseboards occurs as a subsequent decorative scheme--cream on the upper portion and light reddish-brown on the lower portion, dated ca. 1810. This scheme also appears in rooms 105, 106, and 206.

A reproduction baseboard related to c. 1840 masonry and mantelpiece changes by Van Buren has provided a datable cream base color. Sample 559 from the ca. 1840 reproduction baseboard has six paint layers compared with the eleven layers of sample 558. Layer number six, representing the fourth or fifth paint scheme, is the cream layer before a white layer, which changes from brown to black with Na₂S testing. This particular layer will be matched for the restoration of all woodwork finishes.

(4) Room 105

The major elements of doors, their casings and entablatures, baseboards, and east window frames show a similar chromochronology that suggests the 1797 date of construction.

The original paint scheme consists of a grayish-white primer (probably discolored) with a light yellow finish color (see samples 231, 236). The second paint scheme represents early 19th century polychromy--all woodwork of cream with doors and lower baseboards of a light reddish brown (see samples 052, 223). The third paint scheme is dated to ca. 1840, with samples found on door 108

(sample 059) and its casing (sample 243) and window 129 casing (sample 244). These elements in the west wall have several base layers of cream and have been related to Van Buren's relocation of the main stair.

A fourth paint scheme also consists of base layers of creams and has been identified as ca. 1849 work of Upjohn because of the sample elements representing Upjohn's redesign of the stair treads (sample 226), door 130 bracket (sample 239), and the west wall baseboard (sample 225).

Paint analysis of a fluted molding reused in room 301 (sample 560) confirms the dating of the third scheme of cream paints to Van Buren, ca. 1840. This fluted molding, which matches the molding found in room 105, contains only two layers of cream paint. This woodwork may well have been removed by Upjohn when the stair hall (room 110) was redesigned.

Changes in the baseboards have not been datable because of the light reddish brown found only on lower baseboards. Early sampling does not reflect exact locations of upper or lower baseboards.

The original 1797 plaster walls are decorated with freehand wall paintings applied directly to the plaster brown coat. A layer of blue paint was also put on these walls before hanging the scenic wallpaper. These walls are found at the east end of room 105 on the north, east, and south walls. See appendix K for Margaret Coffin's study of freehand wall paintings.

(5) Room 106

Most of the architectural elements in this room, including the ogee arch and pilasters, appear to date from the 1797 period (samples 248, 250, 253). Door 133 and its casing are the only elements in the room that appear to be of a later date (see samples 246, 671, ca. 1849). The earliest layers on the 1797 woodwork include a primer of cream and a finish coat of pale green or blue. Subsequent layers consist of creams and whites. A light rust layer appears on the lower baseboard at a time when remaining architectural woodwork was painted a cream color. The samples consist of approximately eleven layers of paint, representing six possible paint schemes.

(6) Room 107

Wood shelving at the south end, the south wall enclosed within the shelf area, and baseboards share a chromochronology of base red, cream(s), blue, creams, and whites (samples 036, 037). Door 135 casing and the east plaster wall below the top shelf do not include the base red, but otherwise they appear to be the same. The west plaster wall below the top shelf consists only of creams and whites. The Dutchmen in the door casing and door have fewer layers of cream, blue, creams, and whites. The plaster wall above the top shelf has a surface layer of blue gray and may not have been painted originally.

(7) Room 108

Early red and blue layers were found on north wall locations of baseboard and plaster (samples 261, 264). The absence of such layering on the east wall (sample 262) suggests a similarity with room 107 where an unexplained variation exists between the wall and shelving finishes. The doors and casings (samples 132 and 134) leading into the major rooms share the subsequent layering of the north wall samples, which includes cream V, pale green f, cream V, cream F, a thin white graining base with a sand-colored and opaque graining-type layer with varnish, and layers of white, green, white, and gray, totaling approximately nine layers. Door and casing 131 to the basement (samples 259, 260) and the west end of the south baseboard (sample 263) lack several of these base layers of cream and pale green. This evidence should coincide with the entire stair and wall relocation that introduced new stairs leading into the basement ca. 1840.

(8) Room 109

The supposition that changes had occurred in the location of the north wall was confirmed through examination of cornice, plaster wall, and baseboard paint samples. Whereas the west wall cornice paint sample (044) showed four to five paint layers, the north wall sample (043) showed one layer. However, the east end of the north wall (sample 478) also had four to five layers, which suggests an original L-shape to the room by its northeast corner closet.

The east wall sample from the plaster wall (047) exhibits four to six layers, including pale green, red lead, varnish, blue, cream yellow, and white. These early paint colors are found on the south wall as well and represent the early decorative paint scheme in this room. See appendix K for Margaret Coffin's report on freehand painting. The north wall, which was suspected to have been built at the time of the central stair relocation, shows a possible three layers (sample 048) of white sizing, cream yellow, and white. It is of particular value that the cream yellow and white uppermost layers did not react to the application of sodium sulfide and that the east wall chair rail plaster infill, which does not occur on the north wall, has the three layers (sample 268) of sizing, cream yellow, and white. This evidence not only supports the later construction of the north wall but also strongly suggests that the chair rail in this room and possibly other rooms, was removed at the same time. The installation of the scenic wallpaper in the original stair hall (room 105) also necessitated the removal of the chair rail (evidenced by the plaster infill and additional wallpaper lining used in those areas) and relocation of the stairway.

The south wall door (128), leading into Upjohn's addition, provided the chromochronology for identifying the 1849 paint layers (samples 275, 276). This sequence includes cream and x cream(s) (turning light brown), a fracture, and often another cream and x cream. A north wall baseboard sample (269) taken at the west end was thus identified as being ca. 1849 work. However, midway on the same wall (sample 270), additional layers of cream(s) were found, which suggests the reuse of this baseboard. The early pale green and blue layers on east (267) and west (273) baseboard samples introduce a variation from other 1797 woodwork.

In other samples of the window 125 casing (046), mantel (045), and door 132 (271, 272), early layers of pale green and cream(s) were found, but the blue on the east and west baseboards was not included. The early pale green layer was not found on door 133 and its casing. The base layers of cream suggest a ca. 1840 origin for these double doors and may possibly be an earlier change. Doors 120 and 129 have one layer of 20th century paint (possibly latex) over what appears to have been an original natural wood finish of its solid walnut construction.

(9) Room 111

The one question of change centers on door 127 that was added in the west wall for passage into room 112. The general chromochronology appears to match all other woodwork in this room. The original base layers of tan, however, are very difficult to distinguish in their quantities.

There are approximately eight layers of paint on woodwork, with an original two base layers of light brown followed by a fracture, and a subsequent scheme of cream (see samples 109, 111, 116).

The painted plaster wall area revealed by the casing removal at door 127 indicates that the walls were originally painted a medium brown color (see sample 127). The room description for room 111 suggests bookcase areas outlined by paint residue ghosting.

(10) Room 112

The original paint color scheme was tan for all woodwork, unpainted plaster cornice, and the ceiling, with papered walls.

The chromochronology of woodwork varies between 11 and 21 layers and includes cream(s), white(s), a fracture and occasional dirt layer, several graining layers, white(s), light green and light blue, black, and yellow. The graining appears to represent the fifth scheme (see samples 88, 101, 102).

Door 124 contains the cream paint with blue pigment particles found on the walls and woodwork in rooms 114, 115, and 116, indicating it is reused (see sample 576). Its casing, unlike the other woodwork in the room, has only one layer of graining, indicating that the exterior door in this room is a later alteration (see sample 090).

As in room 111, door 127 and its casing have a full sequence of layers, indicating that any alteration that might have been made to it to open a passage between rooms 111 and 112 was made early (see samples 087, 094).

Removal of the door 124 casing and discovery of three wallpaper layers before any painting of the plaster walls allowed comparison of wall paint with cornice and ceiling paint. The base layers of both walls and the ceiling and cornice are identical and indicate that the ceiling and cornice were not painted until after the walls were no longer papered, ca. 1890 (see samples 581, 582, 584, 585).

(11) Room 113

There are approximately five paint schemes in this hall. A representative sample (280) shows two original layers of tan, followed by white, cream base and graining, white, and cream. The board partition was added at the time of the third scheme of graining. Sample 277 from the partition has a white base with graining and a surface layer of white.

Stair treads and risers were painted a light brown color, unlike the other woodwork in the room (see sample 688). The newel post, banister, and rail are varnished.

(12) Room 114

Rooms 114, 115, and 116 are the only rooms other than room 111 in the Upjohn addition whose plaster walls were originally painted. In room 114 the original finish coat on the plaster and woodwork was a cream paint with large blue pigment particles. A typical plaster sample in room 114 is sample 592. Its chromochronology includes a cream primer, a finish cream with blue pigment particles, two dark green layers, two sand-colored layers, a cream, a light yellow, a light green, a magenta, a white, and a light gray. A representative sample from the woodwork is sample 297. Its paint layers include a cream primer, a finish cream with blue pigment particles, one to two layers of graining with base cream colors, white, green, and light gray. Variations in these chromo-chronologies occur in four areas: the north and west walls, the center of the east wall, door 123 in the west wall, and door 116 in the north wall.

The northwest corner of room 114 appears, from physical evidence, to have been the location of a wood-encased tub. The absence of early paint layers in this area suggests that the area was not painted originally (see samples 602, 609).

In the center of the east wall, between door 117 and the fireplace, the early layers of paint are also missing on the baseboard and the plaster walls. This absence, combined with other physical evidence found in the area, indicates that the lavatory stood here (see samples 604, 605).

Paint layers on the inner jamb of door 123 appear to relate to the exterior brown color and may represent reused wood. There is no casing that finishes off this door insertion. The door itself does share the predominant woodwork chromo-chronology.

The door 116 casing does not have the base cream layers; it begins with graining. The door does have the original base creams with blue pigment particles.

Extensive sampling of the plaster walls also revealed, by the absence of the three earliest layers of paint, three vertical posts that appear to have been part of a frame surrounding the bathtub, and a horizontal pipe chase associated with the frame, approximately 1' below the cornice and about 2' wide.

Discovery of the second paint color scheme of green on the plaster wall under the door 116 casing suggests that the original cream walls were painted green before the addition of this north wall door, the woodwork was grained at the time of this alteration, and the walls were once again painted green when the bathroom fixtures were removed.

The plaster cornice and original plaster ceiling were of an unpainted, white-coated plaster.

Visual similarity between the green paint layer in rooms 112 and 114 was rejected through chemical testing. Sample 085 from room 114 did not react to Na_2S , while sample 605 from room 112 reacted positively with a change to black.

(13) Rooms 115 and 116

The original paint color for all woodwork and plaster is cream with blue pigment particles. It is the same color used in the bathroom, room 114. In room 115 the paint on the plaster walls and woodwork is the original finish coat of cream paint with blue pigment particles. It has darkened considerably with age. In room 116 this original finish has been covered over with three layers of later paint.

(14) Room 117

This room was included in the paint study for the purpose of dating the south partition wall. All samples analyzed showed base layers of tan, cream yellow (turning light brown), a graining layer, and white (see sample 298). The original tan does not appear on door 121 and the south partition. Door 118 has blue pigment particles in the original base color of cream. The subsequent graining layer on door 118 and the base graining scheme on door 121 suggest that the partition was added at the same time that the folding door from room 115 (D138) was relocated to its present position.

(15) Room 118

The original paint color of cream is evidenced by several very thin layers followed by a layer of light brown. It is difficult to distinguish the cream and light brown as separate paint schemes in some paint samples. In room 121, however, the light brown does not react to Na_2S testing, as do all other ca. 1849 Upjohn paints.

The addition of door 116 and its casing was confirmed through paint analysis. The flat board casing (samples 306, 672) does not have the lower layers of creams and light brown, and the door (sample 628) has an early layer of cream with the blue pigment particles found in room 114 (see samples 136, 601).

The southwest corner baseboard (sample 630) has only the original cream layers. The wall and floor area covered within this corner baseboard area corresponds with the furniture ghosts on the wall and floor. The absence of paint layers beyond the original cream color suggests that the furniture was not a built-in piece installed before painting and that this furniture remained in place until fairly recently.

The baseboard area covered by a later floor and possibly a quarter-round molding exhibits only the base layers of creams and light brown. The wood floors have five layers of paint with a base of varnished gray that has blue pigment particles (sample 632). These paints do not react to Na_2S . It is, therefore, assumed that the floors in this room were not originally painted.

The ceiling in this room was unpainted.

(16) Room 119

The samples from woodwork attributed to Richard Upjohn generally occur in a sequence of cream (one or two layers), x white, fracture, white, fracture, green, and white. These samples include east wall baseboard sections, north wall window and door casings, east wall window casings, and door 119 on the south wall (see samples 314, 317). The major variations are found in the area of door 108 on the east wall. The jamb paneling (sample 504) has a possible total of four to five cream layers before the white (brown) layers, and the sash of window 129 (sample 318) has four to five such cream layers. Both of these elements should date from an earlier period than 1849. Door 108 (sample 316) has several cream layers followed by several brown and glazed layers, x white, and white(s). No other element shows this brown color.

Plaster walls in this room are painted two colors: The upper parts are lime green; the lower parts are mauve. Underneath the surface layers of paint is a layer of blue paint. None of this paint reacts to Na_2S . Originally, the walls appear to have been wallpapered.

The ceiling was painted with calcamine.

(17) Room 120

Woodwork sample 320 shows an original cream layer and a surface color of white. The plaster walls and ceiling are unpainted.

(18) Room 121

Woodwork sample 323 shows an original cream layer and a surface paint of light brown. Because the surface layer of light brown does not react to Na_2S testing as do all other ca. 1849 Upjohn paints, the base cream color is recognized as the original finish. Plaster walls and the ceiling are unpainted.

(19) Room 122

The original tan color of all woodwork shows later layers of white (sample 620). The irregular surface layer of cream on the plaster walls covers the base layer of whitewash. The ceiling is unpainted plaster.

(20) Room 123

The original woodwork of a tan paint color was followed by light yellow, cream, and multiple layers of white. The tan color is the same as that used in rooms 111, 112, 113, and 117 (see sample 330).

The white base layers of plaster wall samples react positively to Hc1 testing, which suggests an original whitewash finish (sample 327). Subsequent layers include light yellow and white. No physical or documentary evidence of wallpaper has been found.

The existing blue paint on the ceiling is a modern, 20th century paint (sample 627). The ceiling finish should be the unpainted, white coat of the plaster finish found in all other ca. 1849 Upjohn rooms.

(21) Room 201

West window 212 is the only woodwork that has been dated post-1797. Paint analysis confirmed the comparative moldings analysis that dates the window casing, doors, vertical board backing, and shelves to Upjohn work of ca. 1849. The base cream layers (samples 554, 555) coincide approximately with layers four/five on paint samples from original 1797 work (sample 338).

All other woodwork, including windows, doors, their casings, and the mantelpiece and paneling, represents original 1797 work. The base layer of light yellow is followed by multiple creams and whites. Baseboards have a base color of blue.

The whitecoated plaster walls have small areas of pink calcimine.

(22) Room 205

Four variations were found in the comparative sampling of this room. The general sequence of original 1797 fabric includes an initial cream layer, with green pigment particles followed by creams and whites. This chromochronology appears on baseboards, doors 203 and 204, the window casings, the mantelpiece, and its paneling. Variations are as follows: Shutters have a base of cream and a surface of white; door 206 and its casing have a base of gray white and a surface of white, totaling only two layers; door 205 and its casing have a base of cream and upper layers of white; and the south (sample 067) and west (sample 068) baseboards have a cream primer and light reddish brown finish coat as the earliest scheme. Both sections of baseboard may be related to relocation of doors on the west and south walls. Paint analysis of doors 205 and 206 must be combined with other physical evidence for definitive dating.

There is a distinguishing white layer (sample 6 or 7) that slowly changes to a light brown gray and may represent Van Buren work. A fracture follows this layer, then white (thin) and light cream that might represent subsequent painting during the Upjohn alterations.

(23) Room 206

Differences among baseboards support the suspected alterations for this space. With removal of the U-shaped stair at the west end of this room, baseboards were newly installed on the north, west, and south walls. The relocation of the stair immediately south required moving a wall and installing a baseboard on the south end

of the east wall. These samples (159, 161, 162, 163) have early cream layers followed by white layers that have an intermediate brown-gray reaction to the Na_2S . The earliest (ca. 1797) remaining segments of baseboards on the north and east walls have an additional three to four earlier layers of gray white, yellow cream, and light rust.

The three doors (209, 210, 215) and their casings were unaffected by the changes in this room (despite moving door and casing 215). The full chromochronology is evident (see samples 165, 167, 168, 071, 170, 074, 171) and agrees with that of the baseboards. The doors have only a light rust layer as layer three, indicating a scheme of cream woodwork (casings) and light rust baseboards and doors (pre-Van Buren).

The door 211 casing (samples 070, 169) does not show the full sequence, although the earliest cream layers are too numerous to represent Upjohn work. The door itself (166) does show the Upjohn chromochronology. The casing was no doubt moved to this location by Upjohn (or Van Buren?) and represents reused woodwork.

A sample (482) taken from the hot-air heating grill casing (found within D210) suggests that its earliest layer of white, which is particularly distinguishable in most samples by its reaction to Na_2S (brown gradually turning gray and finally black), may be dated to the installation of the 1854 patented furnace (or earlier).

West wall window 213 elements (samples 173-75, 479, 481) appear to date to an Upjohn installation. The layering begins with cream(s), followed by white(s).

The arch between rooms 206 and 207 was sampled extensively for accuracy of dating and for evidence of polychromy. Elements include the pilaster tracery and backing, both sides of the arch, the baseboard (plinth?), and the north and south edges of each pilaster (where paneling varied from the tracery). Paint samples suggest a 1797 date. The chromochronology does not include the early gray white, yellow cream, light rust, or blue found elsewhere in the structure. The earliest arch layer of cream became noticeably lighter and closer to the earliest grayish white layer under ultraviolet light. The chromochronology includes cream (dirt and fracture), cream (varnish and fracture), cream and x white (turning brown gray), and white(s).

The closest similarity is found in the sample of door 211 casings (samples 070, 169). It is possible that the decorative scheme that includes the light rust layer may coincide with the arch installation.

Samples of the north and east plaster walls contain gray, blue, green, and cream. The gray and blue paints are from the freehand wallpaints that were the first finish on the plaster walls in this room (see appendix K). The south and west walls only have the modern layer of cream paint.

(24) Room 207

Analysis for this room supports the theory that work within the entire second-floor central space was undertaken not long after the initial 1797 construction. This period of work probably coincides with the residency of William Van Ness, ca. 1804-24.

The baseboards (077, 183), door 202 and its transom light (185), and door 217 and the arch with pilasters appear to date to this period of remodeling. The early paint layers found on door 204 and its casing are not visible on these elements. The door 204 casing has a similar sequence, with a light yellow base as the exception. The chromochronology of door 204 matches that of doors 209, 210, and 215 in room 206.

The plaster walls generally share a sequence of gray, blue, and green, with several exceptions. The south end of the west wall and the north wall have an earlier layer of pale green. This pale green layer served as the ground color for the original decorative painting in this room (see appendix K). The north end of the west wall includes a cream layer after the blue, and the chair rail infill area shows cream(s) primarily.

(25) Room 208

The distinguishing layer of white that turns from brown to black under Na_2S testing is critical for the study of samples in this room. The early layers are comprised of approximately four layers of cream that are followed by white (quickly turning brown to black), white (changes to a light brown), yellow, and white. The number of cream layers before the white layer (brown to black) provides the clue.

Window elements, doors and door casings, and the east baseboard have three to four layers of cream. A fracture is generally found between the next white layer (turning brown to black) and light brown (turning white). Although this chromochronology does not appear to be similar to other 1797 schemes, it does seem to represent the early 1797 period of the room. It was apparently treated differently from other second-floor central hall spaces.

The door (202) between rooms 207 and 208 and the west, north, and south baseboards all appear to have fewer of the early cream layers, probably only two.

All plaster walls share a base layer of dark green that does not occur in the chair rail infill. The north and east walls also have an original layer of pale green paint. This is the ground color paint for the decorative freehand wallpainting in this room. A 20th-century surface layer of yellow, post-dating the intervening wallpaper, finishes.

(26) Room 209

Early grayish white and cream layers are followed by a fracture and a distinguishing sequence of white, brown, and varnish. This sequence appears to be graining that resembles work found in room 108. Whites follow the graining.

Samples from the mantel (355-356), door 216 (363), and door 217 (362) appear to share their chromochronology, with slight variations. The door casings themselves, however, have fewer layers. The door 216 casing (361) only has layering that is subsequent to the graining, and door 217 casing (360) has the brown layer, white(s), and white(s).

The window 218 casing (354) and the interior shutter (359) have several creams and whites. The interior side of the shutter also has a surface layer of graining. The only suggestion that could be made is that the casings were never part of the "graining" scheme and were seldom painted.

The two baseboard samples, although of great interest, pose many questions. The east wall baseboard shows several variations (357): one sequence has the early cream and light rust, followed by creams, brown, and whites, and one has an early green layer. The north end of the west wall baseboard has four variations (358), only one of which includes the brown layer. In situ scraping revealed a brown diagonal squiggle pattern on this baseboard.

All plaster walls share a base layer of dark green that does not occur in the chair rail infill and a 20th century light green calcimine surface layer that post-dates the intervening wallpaper finishes. The east, south, and west walls have an original layer of pale green paint. It was the ground color for the freehand painting in this room.

(27) Room 210

Samples 364 and 366-369 show remarkable similarities that should, together with other information, date these elements to the 1797 date of construction. The elements include the north and east sections of baseboards, the mantelshelf, and door and door casing 215 (into room 206). The layering consists of the early grayish white, blue, creams, and whites. There is occasional evidence of the light reddish brown layer on baseboards only, sufficient to suggest polychromy.

Window casing 216, which is of obvious Upjohn design, has a valuable chromochronology that provides the datum identification of cream, cream, cream, cream, and white(s). The sequence appears as layer numbers five to six on other room elements. Door 216 appears to match the Upjohn sample (370).

(28) Room 211

Paint samples taken from this room indicate that originally it had the same paint scheme as the tower stairs, from the basement to the second floor. Woodwork was painted tan (sample 667); floors were painted light brown (samples 665 and 666); and the walls and ceiling were unpainted. The interior of the closet, with the exception of its floor, was also unpainted. Only the woodwork received any post-1849 finishes. It was grained once and also painted white (sample 667).

Paint samples do not indicate that any alterations have been made in this room.

(29) Third Floor

The finishes on the third floor of Lindenwald are basically unchanged since Upjohn made major alterations to this floor ca. 1849. Walls and ceilings are plastered and whitewashed (sample 703); woodwork has a white primer and a gray finish coat (samples 694-701, 704-708); and floors are unfinished. Only door 304 appears to be a later addition; its casing is unfinished.

Although the current finish on the woodwork is the same throughout the third floor and can be dated to Upjohn, early paint layers on many of the doors and casings indicate that they were reused from elsewhere in the house. These doors include 301 (sample 707), 303 (sample 697), 305 (samples 688, 700, 702), 306 (samples 704, 705), and 307 (sample 706). Further study of these paint layers and the method of construction and moldings of the doors may identify their earlier locations at Lindenwald. This information will be valuable for identifying the alterations that were made to the house.

(30) Tower Stairs

The tower stairs vary in degree of finish from the basement up through the tower. From the basement up to the second floor the woodwork was originally painted tan (sample 278); the stairs, treads, and risers were painted light brown (samples 668, 669, 279); the walls and ceilings were plastered and unfinished; and the banister, newel, and rail were varnished.

At the first landing above the second floor the stairs and centers of the treads are not painted. Above the third floor neither the treads nor risers are painted. The woodwork, baseboards, window sash, and casings continue to be painted tan up through the tower. Room 307 has the same finishes as the third floor of the tower. Only the baseboards, from the basement to the second floor, have later finishes. They were first grained and then painted white.

Paint samples do not point out any alterations that have been made in the tower.

c. Exterior

The chromochronologies of the paint samples from the exterior of Lindenwald reveal that the 1797 part of the house was painted approximately six times, and the 1849 Upjohn addition was painted approximately three times. The colors of the different architectural elements of the house for each of these paintings are identified in the chart at the end of this section.

Comparison of the paint samples from the original house and the Upjohn addition indicates that the fourth paint scheme represents the colors Lindenwald was painted when the Upjohn addition was built. The brick body of the house, shutters, dormer sheathing, and window casings were painted light yellow (samples 521, 650, 713); and the built-in cornice/gutter with modillions, the Upjohn porch, the

brick window lintels of the 1797 house, and the brick and rubblestone areas below the water table were painted brown (samples 203, 527, 530, 562, 564, 567). The window sash was painted cream (sample 562); the terneplate roof of the 1849 addition was painted green (samples 005, 006).

In addition to revealing the six different paint schemes, the exterior paint study confirmed several suspected exterior alterations and provided important information about the types of finishes used on the Upjohn porch and the foundations.

Alterations confirmed through paint analysis include the additions of window 118/119 (sample 509), window 122/123 (in situ scraping only), door 123 (samples 132, 137), door 24 (sample 550), window 215/216 (sample 371), windows 302, 305, and 307 (samples 536, 539), and the east Upjohn porch.

Paint analysis also confirmed that the patches of stucco over windows 103 and 104, incised to look like brickwork, were made before the 1797 house was first painted (sample 709). The patches suggest that the original openings left for the windows were the incorrect size.

Paints used on the exterior surfaces of Lindenwald ca. 1850 were lead-based paints. Paint samples taken from the Upjohn porch (samples 200, 203, 209) indicate that sand was applied to brown paint to simulate brownstone. Paint samples taken from the rubblestone foundation of the 1797 house also indicate that this area had a sand-type finish (sample 530). The layer containing the sand is on top of a light brown paint. Unlike the sand-filled paint layer on the porch, the layer containing the sand on the rubblestone does not contain paint. (There is no reaction when this layer is spot-tested with Na_2S or DMF.) This suggests that it may be more like a stucco finish than a paint finish. On top of this sand-filled layer are the cream primer and brown finish coats that were used to paint the 1849 Upjohn trim.

A similar layer on top of a stucco-like finish is found on the brick foundation of the ca. 1849 part of the house (sample 564).

d. Conclusions

The scope of this paint study makes specific conclusions, apart from the specification of colors for the painting of the different parts of the house, difficult. Some general observations follow:

The restoration colors of cream and tan for most interior rooms represent the fourth or fifth paint layer on the elements of the house dating to 1797.

Both interior and exterior surfaces were not painted very often, considering 183 years for the 1797 house and 131 years for the 1849 addition--the exterior had approximately six paintings, and most interiors averaged ten to twelve (?) paint schemes.

	Original House		
	First Painting ca. 1797	Second Painting ca. 1810	Third Painting ca. 1840
Brick	red	white	cream
Wooden trim	cream	cream	cream
Shutters	*	green	green
Brick lintels	red	white	cream
Window sash	white	white	white

	Original House/Upjohn Addition	
	Fourth Painting Original House/ First Painting Upjohn Addition ca. 1850	Fifth Painting Original House/ Second Painting Upjohn Addition ca. 1870
Brick	cream	white
Wooden trim	brown	brown
Shutters	cream	red
Brick lintels	brown	white
Window sash	cream	white

	Sixth Painting Original House/ Third Painting Upjohn Addition ca. 1890
Brick	white
Wooden trim	cream
Shutters	brown
Brick lintels	white
Window sash	white

* Shutters were not installed at Lindenwald until ca. 1815.

Creams, tans, and whites were unequaled as a favored color from 1797 to 1974.

Polychromy was only in evidence ca. 1815 when lower baseboards and doors were painted a light reddish brown or possibly grained to resemble cherry wood; other woodwork was painted a cream color at this time.

Room 112 succumbed to the greatest number of paint layers--up to 21 layers.

The changes in the exterior paint schemes were often dramatic and typical within their respective periods of 1797, 1815, and 1840.

2. Wallpaper

The wallpaper study for Lindenwald was conducted during the fall of 1979. The objective of the study was to identify the ca. 1850 wallpapers at Lindenwald. This information will serve as the basis for reproduction of the wallpapers that will be used to restore the interior rooms. The wallpapers uncovered during the study also provided information about alterations that had been made in some of the rooms (see section IV.B.2., rooms 112, 118, and IV.B.3., room 205).

a. Procedure

(1) Sampling

Wallpaper samples were removed from the plaster walls with a scalpel and spatula. They were placed in acid-free folders and labeled with the site, location of the sample, date, and person who removed the sample. Each wallpaper was given a catalog number, MAVA 01 WP___. Wallpaper samples were found behind large pieces of furniture (WP002-006), under later door casings (WP011-014), on fireboards (WP017, 019), and under later layers of wallpaper (WP015).

(2) Laboratory Analysis

Preparation of Sample - This was done by separating multiple layers of wallpaper with steam and by cleaning surface dirt off the samples with a soft bristle brush.

Microscope Analysis - Samples were examined with a 10x-70x binocular zoom microscope. Surface characteristics of the paint used for printing were noted, and the technique of printing was identified. Individual paper fibers were also examined under the microscope.

Chemical Testing - The objective of chemical testing was fiber identification. Samples were first spot-tested with phloroglucinol and HCl to determine if they were made of mechanical wood pulp (after 1860). If they did not react positively to this test, slides of the individual fibers were made. The fibers were then stained with Seleger's stain and their color change noted under the microscope. Rag fibers turn red; chemical wood pulp fibers turn blue; and mechanical wood pulp fibers turn yellow.

(3) Photography

Wallpaper samples were photographed with a Nikon camera on a copy stand. Samples were placed against a black background. Black and white 3" by 5" prints and color slides of each of the samples were made.

(4) Documentary Forms

A documentary form for each of the early wallpapers was completed. The form contains a black and white photograph of the wallpaper and identifies its physical characteristics and whether it had a border. If it had a border, the physical characteristics of the border are also identified.

b. Room Descriptions

The room descriptions for the wallpaper study are organized chronologically. The wallpapers listed first for each room hung on the substrate. The fireboards in the rooms are also identified, and their papers are listed, with the layer of wallpaper directly on the canvas listed first. Historical references for the wallpapers are cited, and recommendations for their conservation and reproduction are made.

Research conducted for the preparation of this "Historic Structure Report" used correspondence between Van Buren and a friend, Harriet Butler, regarding the wallpapers purchased by Van Buren in 1841. The correspondence indicates that Van Buren purchased new wallpaper for all the rooms in the 1797 house. The correspondence also indicates that the wallpapers were acquired from the firm of Pares and Faye in New York City.

Readers will note that the scenic wallpaper in room 105 is not described in detail in this study. Its description is contained in a separate report detailing conservation treatment.

Room 005

Wallpaper:

The wallpaper in this room is a striped, floral wallpaper. It has a white ground, orange flowers, and green leaves. The paper still hangs on the walls in this room and has deteriorated markedly. Its advanced state of deterioration makes dating difficult; however, it appears to be a ca. 1850, rag-pulp wallpaper from the Van Buren period.

No fireboard.

Historical References:

None.

Recommendations:

The wallpaper should be reproduced from the original samples found under the north wall baseboard in room 108.

Room 101

Wallpaper:

There is no early wallpaper in this room. The paper currently in room 101 is plain (mechanical wood), has been painted over--first time pink, second time cream--and does not date to the Van Buren period.

Fireboard:

Three layers: The first, which dates to the Van Buren period, is a scenic paper marked *Vue D'Ecosse*, with a gray strip and mountain stream in foreground, sheep in background. The scenic panel is too small for the fireboard, so gray panels have been inserted at the sides to fill it out. This paper has a floral border in gray, blue, and green, with gold flocked leaves (same as fireboard border in room 205).

The second layer is a floral paper, ca. 1880, in green and maroon with a maroon flocked band; the floral border is of brown, green, gold, and maroon.

The third layer is a brown floral pattern that does not appear to have had a border.

Historical References:

This room is probably the room that Martin Van Buren referred to as the downstairs bedroom. In a letter to Harriet Butler, he said the following about the wallpaper for this room. "No. 2. This is to be the best Bedroom and is downstairs. Paper should be good" (Down's Collection). Harriet Butler replied to Van Buren's request for wallpaper for this room as follows: "I sent up or requested the young man who waited on me to do so, two kinds of paper for the lower bedroom - one at \$1. for a piece the other 10/that at a dollar, one of the firm thought would be the best and said he would stand between me and harm" (Van Buren Papers, CCHS).

Recommendations:

Wallpaper:

In the absence of a sample of historic wallpaper for this room, a reproduction wallpaper and border the same as the historic ones in room 205 should be hung in room 101.

Fireboard:

The later layers of wallpaper should be removed and the original scenic panel and border restored.

Room 104

Wallpaper:

Three layers--green lining; gray and black star pattern (Van Buren); blue and pink floral paper.

Fireboard:

One layer--scenic, tiger and lion, rococo border, 4" wide (Van Buren).

Historical References
Wallpaper:

No specific historical references have been found for the wallpaper in this room thus far.

Recommendations:
Wallpaper:

The wallpaper with gray background and black star pattern should be reproduced. This paper should be hung with the rococo border found on the fireboard.

Fireboard:

The scenic panel and border currently on the fireboard should be restored.

Room 105

Wallpaper:

Two layers--green/white lining paper; Zuber scenic with balustrade dado (Van Buren).

No fireboard.

Historical References:

The scenic wallpaper is Zuber's "Paysage a Chasse," first produced in 1831. The balustrade was also manufactured by the Zuber factory.

Recommendations:

The scenic paper and balustrade are currently being conserved by James and Patricia Dacus Hamm. A complete record on the conservation treatment is available at the site.

Room 106

Wallpaper:

Five layers--blue floral/border; gray floral; gray and gold striped/flocked border (Van Buren); brown and gold floral/border; brown and gold floral/border.

Fireboard: Two layers--scenic/horseman (Van Buren); brown and gold floral/border (same as layer 5 of wallpaper).

Historical References:
Wallpaper:

This room was probably the drawing room, which adjoins the dining or breakfast room (109). Van Buren wrote the following to Harriet Butler about this room: "No. 3. Let this be of the same kind with that which was sent for the dining room, yellow with gold, etc." (Down Collection). Harriet Butler only referred indirectly to the wallpaper in this room when she said, "There was no pattern among the borderings for the fire boards that would match very well the drawing room paper" (Van Buren Papers, CCHS).

Recommendations
Wallpaper:

Layer 3, the wallpaper with the white background, gray floral clusters, and gold stripes, should be reproduced. The brown flocked geometric border used with this paper should also be reproduced.

Fireboard:

The later layers of wallpaper on the fireboard should be removed. The original scenic panel and border on the fireboard should be restored.

Room 109

Wallpaper:

Evidence found on the plaster walls in room 109 indicates that the same wallpaper that hung in room 106 hung in this room. This evidence includes the same embossing pattern in the later paint layers of room 109 as that of the room 106 wallpaper.

Fireboard:

Three layers (only the frame and a few fragments on it remain): The original which is from the Van Buren period, appears to have been a scenic because of similar paints; it is not possible to tell anything about the scene from the fragments. The border for the scenic is the same as the flocked border for the third layer of wallpaper in room 106.

The second paper layer had some sort of blue border.

The third layer was the same as the second layer on the fireboard in room 106.

Historical References
Wallpaper:

This room was probably used as the dining room. Van Buren referred to the paper in the dining room as being "yellow with gold." Harriet Butler made no reference to this paper.

A sample of the wallpaper was also found above door 131, in room 108, which is the closet that is shared by rooms 106 and 109. The presence of the same border on the fireboards from rooms 106 and 109 lends additional support to the use of this paper in both rooms.

Recommendations:
Wallpaper:

The same wallpaper and border reproduced for room 106 should be used in this room.

Fireboard:

The fireboard should be restored with a reproduction scenic panel. Further research is required to determine what the panel should be. Once the later papers have been removed from all of the scenic fireboards, it will be possible to determine whether the fireboards purchased by Van Buren were part of a set. If they are a set, the missing panel should be replaced, probably by a hand-painted panel. Otherwise, an appropriate commercially manufactured panel should be purchased.

Room 112

Wallpaper:

Three layers--pink and beige striped (Van Buren); blue floral in diamond pattern; green and gold, striped, classical motifs.

No fireboard.

Historical References:

None.

Recommendations
Wallpaper:

Layer 1, the pink and beige striped wallpaper, should be reproduced. Since no evidence has been found for a border for this wallpaper, it should not be hung with a border.

Room 118

Wallpaper: A single layer, from the Van Buren period, has a blue diamond pattern with small pink flowers at the points of the diamonds. Fragments of this wallpaper were found behind the casing of door 116.

No fireboard.

Historical References: None.

Recommendations

Wallpaper: This wallpaper should be reproduced from the fragments of paper found behind door 116. It should be hung without a border.

Room 201

Wallpaper: One layer, from the Van Buren period, is gray and white with pink and yellow flowers. A fragment of this wallpaper was found under the casing of the window that was originally in the west wall. This is the same wallpaper that is found on the fireboard.

Fireboard: Three layers--gray and white with pink and yellow flowers/4½" border in gray, blue, pink, and green, some leaves flocked (Van Buren); geometric in gray, pink, black, and blue, marked T.C.S.-Thomas Strahan Co. 6238/no border/ brown paper.

Historical References
Wallpaper: None that can be specifically identified as referring to the wallpaper in this room.

Recommendations

Wallpaper: The wallpaper with the gray and white background and pink and yellow flowers should be reproduced and hung with the reproduced border found on the fireboard.

Fireboard: The fireboard should be covered with the reproduction border and wallpaper used in this room.

Room 205

Wallpaper: Ca. 1840 floral, green, brown, and yellow pattern on a white background.

Fireboard:

Three layers: The first layer, which dates from the Van Buren period, is a scenic; the scene is undetermined. The border, a blue floral with gold flocked leaves, is the same as fireboard border in room 101. The panel is not quite large enough to fill the screen, so small strips of gray paper have been inserted along its sides.

The second layer is a gray and pink paper, in a mottled pattern.

The third layer is tan and brown, stagecoaches and wagons. The edge of the paper is marked

A U.W.P.C. of N.A.
O Union Made F
L

Made in U.S.A. -
Conforms to Spec. No. CS 1629
U.S. Dept. of Commerce

Historical References
Wallpaper:

This room was probably the upstairs guest bedroom since it is the only bedroom that had a scenic fireboard. It appears that Van Buren was referring to this bedroom when he said, "No. 5 Bed Room upstairs - may be a little more expensive." Harriet Butler referred to this room and her daughter's occupancy of it, saying "The paper for the upper bedroom, Harriet said she would have an eye to her own comfort as she might occasionally be an occupant of the room."

Recommendations
Wallpaper:

The ca. 1840 floral paper found behind the casing of door 206 should be reproduced and hung with the reproduced border found on the fireboard.

Fireboard:

The later layers of wallpaper should be removed and the scenic panel and border restored.

Rooms 206, 207 and 208

Wallpaper:

Two layers--white background with yellow diamondlike geometric pattern (Van Buren); Japanese style paper of gold, maroon, and black.

No Fireboard.

Historical References:

These rooms comprise the upstairs hall. On May 15, 1841, Van Buren wrote Harriet Butler the following instructions about their wallpaper: "No. 1 This is for the hall upstairs including the temporary bedroom [room 208] at the end of it. Let the paper be neat but not expensive. Something like what we first selected for the lower Hall might do" (Downs Collection). On the 17th Harriet Butler replied, "The hall paper is an old favorite of mine" (Van Buren Papers, CCHS).

Recommendations

Wallpaper:

The wallpaper with the white background and yellow diamondlike geometric pattern should be reproduced and hung in these rooms. Because all of the other wallpapers hung by Van Buren had borders, it is assumed that this paper was also hung with a border--although no border samples have been found in this room. The wallpaper should be hung with a reproduction border like the one in room 210, since it is stylistically similar to the wallpaper.

Room 209

Wallpaper:

No samples of historic wallpaper have been found on the walls of this room.

Fireboard:

One layer, from the Van Buren period, has a green and white body, black Greek key border, gray/garlands outer border (same as lining paper in rooms 104 and 105).

Historical References

Wallpaper:

None that can be specifically identified as referring to the wallpaper in this room.

Recommendations

Wallpaper:

The wallpaper and border on the fireboard should be reproduced and hung in this room.

Fireboard:

Same as above.

Room 210

- Wallpaper: A single layer, which dates from the Van Buren period, is a floral, beige background and white flowers with green highlights. A sample of the historic wallpaper was found under the casing of door 216. This paper is also on the fireboard.
- Fireboard: One layer--floral, beige background and white flowers with green highlights 2-3/4" border, olive geometric flock (Van Buren)
- Historical References
Wallpaper: This room was son Martin's bedroom. Van Buren, writing to Harriet Butler, said the following about the paper for this room: "No 4 Martin's Bed Room - neat but cheap." Harriet Butler in responding said: "That for Martin's Room 5/ is Miss Butler's choice and she did not shrink from the responsibility. There is certainly nothing exciting in the colors and to an invalid it will be rather quieting to the nerves."
- Recommendations
Wallpaper: The wallpaper found behind the casing of door 216 and on the fireboard should be reproduced. It should be hung with the border found on the fireboard, which should also be reproduced.
- Fireboard: The fireboard should be covered with the new reproduction wallpaper and border.

D. Hardware Study

1. Locks

The locks found in the Martin Van Buren house are stock locks, sheet-iron rim locks, cast-iron rim locks, sheet-iron mortise locks, and cast-iron mortise locks. Each type of lock in the house will be described under one of the above categories, and an approximate date of installation will be assigned on the basis of documentary information on the maker or techniques of manufacturing and the context in which the lock was found. Lock terminology used in this section is drawn primarily from the articles by Donald Streeter cited in the bibliography.

a. Stock Locks

Door X01 is a 6' 4-1/2" by 3'10" board-and-batten door with wrought-iron strap hinges and a 5" by 8" by 1-1/8" plate-type stock lock. Because of its dimensions, style, and placement of hardware, this door is thought to belong in door opening 003. The context (hinges, door frame, style of door) clearly indicate that the door was part of the original 1797 construction of the house. The context of the lock does not provide such clear indications. There is evidence of a wrought-iron latch

that may have been the only security for this door before Van Buren bought the house. This lock may have been installed by Van Buren following a suggestion from Harriet Butler, "I am glad to hear from Smith that your storeroom is made. It will need a good lock and the key always in the hands of a trusty person" (Hardenbrock 1938, 16-17). (The lock is a dead-lock or closet-lock having one bolt operated by a key inside and out.) On the other hand, stock locks were certainly available throughout the 18th and 19th centuries. Screws were too rusted to be identified. This lock could have been installed in 1797 or any time thereafter. In any case, it was probably on the door during Van Buren's occupation of the house.

Door 301 carries a stock lock 6" by 4" by 1" with the numbers "116" incised in the end grain opposite the jamb (see IP105). The small size of the bottom rail and lock stile indicate that this door was adapted for use in this opening. The ghost of a 4-1/4" by ? rim lock confirms that this door had an earlier use. A cast-iron thumb latch was installed in the rim lock's place, probably when the door was installed in its present location. It has been demonstrated elsewhere in this report that the third-floor spaces were given their present configuration during the Upjohn remodeling of 1849-1850. It has been assumed that the three third floor chambers served as bedrooms for Van Buren's household servants. This assumption is supported by the presence of a call bell in room 302. In this context it is interesting to note that the only means of locking the thumb latch is on the hall (out-) side of the door. However, it should not be concluded that Van Buren's servants had no privacy and were subject to being locked in their rooms. Because the stock lock and thumb latch were probably contemporary, the main functions of the latch were to hold the door closed in an unlocked condition and to serve as a handle for closing the door from the inside.

b. Sheet-Iron Rim Locks

Lock X02 is a 7" by 4-1/4" by 1" three bolt, sheet-iron rim lock of studded construction (see IP106). The sliding latch bolt is at the top, and the night bolt is at the bottom. The location of the latch bolt and the relation of cam to keyhole indicate that this lock is of English manufacture, late 18th or early 19th century (Streeter 1974, 6, no. 1:41-67). The rusted condition of the lock case and screws ruled out removing the lock for closer examination. A wrought iron staple, the rusted remains of a latch pivot and the hole for a thumb latch lever clearly indicate the former presence of a wrought iron thumb latch. A patched slot may have served for an earlier thumb latch or rim lock. The door and hinges are roughly the same size and style as door X01. Therefore it is considered part of the ca. 1797 construction and probably belongs at door 005.

Lock 210 is a 7-3/16" by 4-3/8" by 1-1/8" three-bolt rim lock of studded construction with a night bolt below and sliding latch bolt above the key bolt (see IP107, 108). The keeper is made of sheet iron with a heavy iron strike attached. Keeper and lock are both attached with early machine-made screws (late 18th century or early 19th century). Similarity to lock X02 and locks described by Donald Streeter (1974, 6, no. 1:41-67) indicate English manufacture, probably before the rise to popularity of the carpenter-type lock (ca. 1835). A careful

visual inspection did not reveal any indication of an earlier lock on door 210. The foregoing facts and the survival of wrought-iron HL hinges on this door strongly suggest that the entire door assembly has survived intact (except for the heating register cutout) from the original 1797 construction. It has been shown that door 210 originally provided access to a steep attic stair. The stair was removed during the 1849-1850 remodeling work, and ducts for the hot air heating system were installed behind the door either at that time or within the next decade.

Locks 201, 203, 204, 209, 215, and 217 are 6" by 3-13/16" by 13/16" two-bolt rim locks of studded construction with a sliding latch bolt below the key bolt (see IP109). The words "Green & Broad/New York" are die-stamped on the end of the key bolt (see IP110). Green and Broad are listed together as locksmiths in New York directories from 1837 to 1845. Thus, these locks confirm the observation that in American rim locks "the latch bolt is usually below the dead bolt" (Streeter 1973, 5, no. 2:9). Locks and keepers are all attached with roundhead early machine-made screws. Partial backplates attached with brass nuts cover the wards (see IP111, 112). The "outside" round brass knobs are fixed to square shafts whose other ends are threaded to receive the "inside" knobs. Inside knobs are held in place by a set screw through the neck of the knob bearing on the flat side of the shaft. There are cast brass roses with three exposed screw holes and oval escutcheons with four screw holes.

Lock 131 is a carpenter-type lock (Trump 1954, 66, no. 6) 7" by 4-3/4" by 1" with a cast brass disc inscribed "J. Walker Improved Lock" around an American Eagle, and "J. Walker" and "VR" under a crown die-stamped on the brass portion of the keeper (see IP113). The initials "VR" for Victoria Regina positively date the manufacture of this lock after 1836. It is attached to the door with later machine-made screws ca. 1830-50. It was probably installed during Van Buren's ca. 1840 renovations, but it may have been altered during the ca. 1850 work. It is a two-bolt lock with a lever-type latch bolt above the key bolt and round brass knobs.

Locks 206 and 207 are 5" by 4-1/2" by 13/16" carpenter-type locks with the same markings, bolt configuration, and knobs as lock 131 (see IP114). They are attached with later machine-made screws of blued steel. Therefore, they fit the same time frame as lock 131.

Lock 216 is a 6" by 4-1/2" by 13/16" carpenter-type lock with a brass disc bearing the legend "No. 60 Improved Rim Lock" surrounding an eagle standing on a globe with a bundle of arrows in one claw (see IP115). Bolt and knob configurations and screws are the same as locks 131, 206, and 207. The absence of paint under this lock indicates that it is original to the door. For further discussion of this door, see the room description.

c. Cast-Iron Rim Locks

Lock 105 is a 3-3/4" by 2-1/2" by 9/16" cast-iron closet lock with beveled rim (see IP116). It is attached with roundhead later machine-made screws. Cast into the back of the lock is the legend,

"P.M. & Co./New Haven/Ct."; Pierpont Mallory & Co. was active in New Haven from 1843 to 1851 (Hennessy 1976, 145). This evidence confirms the conclusion that this doorway was changed to a closet during the ca. 1850 remodeling work (see room description).

Lock 121 is a 4" by 2-1/2" by 5/8" cast-iron latch with beveled rim (see IP117). Cast into the backplate of the latch is the maker's name, "D.M. & Co. NEW HAVEN" and on the inside is the letter "B." Davenport and Mallory Co. was active in New Haven from 1852 to 1857; Davenport Mallory and Co. from 1861 to 1865 (Hennessy 1976, 145). The location of the ampersand on the lock indicates the latter dates. The fact that the door is unpainted beneath the lock indicates that the lock is original to the door and that the door was not installed before 1861. Modern wood screws (gimlet point) are used to attach the lock. Hollow lacquered brass knobs are attached by set screws to a smooth square shaft with a series of holes to receive the set screw and accommodate different thicknesses of doors. Knobs and shafts are probably replacements for ceramic knobs.

Locks 214 and 309 are similar to lock 121, except they are not marked with a manufacturer's name. Both are attached with modern-type machine screws and both doors are unpainted beneath the locks. Lock 214 has brown marbled ceramic knobs, which are probably the originals. Lock 309 has brass knobs with raised center circles similar to lock 201. The knobs were probably removed from door 215. Both of these locks probably date from 1850 (because the doors are unpainted beneath and connect the 1797 part of the house to the 1850 tower).

Lock 123 is a 3-1/2" by 3-3/4" (vertical) by 5/8" cast-iron rim lock with "YALE" cast in the face plate. This lock has brown marbled ceramic knobs and is attached with blued-steel modern-type screws. The cast-iron keeper on the jamb of this door is larger than the lock. The "YALE" mark probably indicates a date of manufacture between 1868 and 1883. Before 1868 Linus Yale, Sr., and Linus Yale, Jr., had concentrated their talents "in designing and making high quality bank locks, which sold for \$100 to \$500 per lock" (Hennessy 1976, 86). The Yale Lock Manufacturing Company was founded in Stamford, Connecticut, in 1868. The company name was changed to Yale and Towne Manufacturing Company in 1883 (Hennessy 1976, 89). The Yale name may have continued in use after 1883, but it seems very unlikely that it would have been used on a lock of this sort before 1868.

Locks 212 and 303 are 4-7/8" by 3-3/4" by 5/8" cast-iron rim locks with molded rims and brown marbled ceramic knobs. Both locks are attached with later machine-made screws. Door 212 is unpainted beneath the lock. Door 303 shows evidence of two previous rim locks. Lock 303 is marked "P.M. & Co." on the back--for Pierpont Mallory and Company of New Haven, Connecticut, 1843-51 (Hennessy 1976, 145). The foregoing information combined with the context for both doors (see IV.B.) strongly indicates an 1849-1850 date of installation for both locks.

Lock 202 is a 3-3/8" by 5" (vert.) by 3/4" cast iron rim lock with a beveled rim on both lock and keeper (see IP118, 119).

The lock is attached with later machine-made screws and has brown marbled ceramic knobs. The legend "West" is cast into the inside of the lock case. No reference to a manufacture of this name has been found.

d. Sheet-Iron (or Steel) Mortise Locks

Locks 101 and 108 are 7-7/8" by 4-3/4" by 13/16" mortise locks of studded construction with faceplates 10-1/8" by 1-7/16" by 1/8" (see IP120). All exposed parts (knobs, rosettes, escutcheons, faceplates, strikes, and bolts) are silver plated. The lock cases are beautifully finished with a shiny surface marked by parallel striations (probably the result of machine grinding). There is only slight evidence of corrosion. The locks are attached to the doors with both modern screws and later machine-made screws. The knob shaft passes through the upper part of the case. The latch bolt is mounted below the shaft at the center of the case. The key bolt is mounted below the latch bolt and the keyhole is at the bottom of the case. The knobs and knob shaft are constructed in such a way that they operate independently on concentric followers, which in turn operate the sliding latch bolt. Two square buttons at the top of the faceplate engage and disengage an internal night bolt that renders the outside knob inoperable. If this night bolt is engaged, one must have a special circular key to operate the latch from the outside. The dead bolt is operated by a key that must pass circular wards which are integral with the lock plates, then the key must lift a sliding tumbler to release the bolt. It appears that the tumbler was originally notched (as in Chubb's 1818 patent*) so that a key with a bit of the wrong length would not operate the bolt. The lower part of the notch and of the keyhole have been filed away to accommodate the present key, which has a longer bit than the original. The springs in this lock are simple strips of steel. Brass screws hold the lock plates together. The escutcheons are rectangular plates 3-3/4" high by 3" wide with slightly inset quarter circles at the corners (see IP121). The edges are beveled. The attached cover is roughly the shape of the keyhole and semicircular in section.

The critical information for dating locks 101 and 108 must be assembled from several different sets of facts:

Locks were attached with later machine-made screws (ca. 1830-1850s).

Parts seem to be electroplated (post-1836).

Both locks have night latches, which implies that door 108 was an exterior door when the lock was installed (pre-1849).

Door 101 had an earlier rim lock (post-1797).

Thus, the installation of these locks can be bracketed between 1836 and 1850. The most likely occasion during that time period is Van Buren's remodeling work of 1840.

*See Streeter 1974, 63-66. This lock, having only one tumbler, is much simpler than Chubb's, but the principle is the same.

Locks 102, 103, 104, 107, 115 (?), 127, 128 (?), 130, 132, 134, 135, and 136, are 3-3/4" by 6" by 5/8" mortise locks of studded construction with faceplates 5-1/4" by 7/8" by 1/8" (see IP122). Door 115 has a faceplate measuring 6-3/4" by 1" by ?. Door 128 has a faceplate measuring 6-7/8" by 1" by ?. No other measurements could be obtained. In both instances, the door knobs were secured to the shaft by means of a pin or rivet which could not be removed rather than the usual set screw.

All exposed parts (knobs, rosettes, escutcheons, faceplates, strikes, and bolts) are silver plated. The lock cases are beautifully finished, with a shiny surface marked by parallel striations (probably the result of machine grinding). There is only slight evidence of corrosion.

The knob shaft and keyhole are located side by side on the centerline with the keyhole nearer the faceplate. The key bolt is at the top of the faceplate, and the latchbolt is at the bottom. The knob turns a follower that acts on a lever that in turn retracts the latch bolt. A simple steel strip spring acts on the lever to return the latch bolt to its protracted position. The operation of the key bolt is protected by concentric wards that are integral with the front and back plates of the lock and by a single lever tumbler (see IP123).

A talon on the tumbler engages a corresponding talon on the bolt to prevent a key with a short bit from opening the lock. A longbitted key would be blocked by the keyhole. There is considerable evidence of hand punching, hammering, and filing to fit the pieces of the locks together. Lock 136 (see IP122) has seven notches filed in the case and in each bolt as assembly marks. Rosettes for these locks are silver-plated cast brass with three screw holes in a recessed area around the shaft hole. A flange at the base of the knob fits into this recessed area, concealing the screw heads. One knob is fixed to the shaft; the other is threaded onto the shaft and secured in place by a set screw that engages in a slot in the shaft. The locks are attached to the doors, and strikes are attached to the jambs, with a variety of screw types ranging from early machine screws (late 18th century/early 19th century) to modern type pointed screws. The early machine screws (they are silver plated, too) must be considered original to the installation of these locks; the later machine screws are probably replacements (although the two types might have been used interchangeably during a transition period); and the modern screws are certainly replacements. Most of these doors show evidence of previous rim locks. Therefore, these locks are not original to the house (1797), but were certainly installed before 1850 (because of the screws). Paint analysis may provide a narrower range of dates for these locks.

Lock 133 is a 5-1/4" by 4-1/4" by 5/8" mortise lock of studded construction with a faceplate 6-13/6" by 1" by 1/8" (see IP124). All exposed parts (knobs, rosettes, escutcheons, faceplate, strike and bolts) are silver plated. The lock case is beautifully finished with a machine-ground surface and all edges squared. The knob shaft and keyhole are aligned vertically in the portion of the case more distant from the faceplate. The latch bolt is mounted above the key bolt, and

both are near the middle of the faceplate. The knob turns a follower that acts on a lever, which in turn retracts the latch bolt (see IP125). A simple steel strip spring acts on the lever to return the latch bolt to its protracted position. The operation of the key bolt is protected by concentric wards that are integral with the front and back plates of the lock and by a single sliding tumbler. The tumbler contained a gate, but its talons have been filed down. The tumbler is held in place by a helical steel wire compression spring. Rosettes for this lock are fabricated of plated sheet metal. The configuration is similar to that of the rosettes for locks 102 et al. except that there are only two screw holes. The knobs appear to be made of brass covered with a silver-plated copper sheet material. Where the silver is worn, copper is exposed; however, the bottom of the flange (which fits in the recess in the rosette) is brass with the legend "HICKS MANUFG. CO. PATENT" (Patent 1654 granted June 27, 1840, to Lucien E. Hicks of Middletown, Connecticut, DPL). This patent concerns a method of making seamless knobs of plated sheet metal. It became obsolete as soon as someone applied the electroplating technique to a cast knob. Therefore, these knobs were probably manufactured within a few years of 1840. The silver on copper covering appears (due to the thickness of the silver) to have been manufactured by the "Sheffield" plate process of hammering or rolling sheets of copper and silver together at high temperature. This technology predates electroplating (invented by Thomas Boulsover in 1836). One knob is fixed to the square shaft, and the other is secured by a set screw that fits into a threaded hole in the shaft. The lock is attached to the door by means of later machine-made screws (ca. 1830-1850). This lock was probably installed by Van Buren in his ca. 1840 remodeling work.

e. Cast-Iron Mortise Locks

Locks X05, X09, 011, 019, 112, 113, 114, 117, 118, 119, 122, 124, 125, 126, 129, and 211 are cast-iron mortise locks 5-1/8" by 4-1/4" by 7/16" with faceplates 6-3/4" by 1" by 1/8" (see IP121). All exposed parts (knobs, rosettes, escutcheons, and covers, faceplates, strikes, and bolts) are electroplated (silver on brass). Lock cases show the grainy surface typical of iron cast in sand molds. The backplate and sides are cast in one piece. The front plate is cast with integral lugs to ensure proper alignment. The knob shaft and keyhole are aligned vertically in the portion of the case more distant from the faceplate. The latch bolt is mounted above the key bolt, in line with the knob shaft. The latch bolt splits into a "Y" shape, with its arms above and below the knob shaft. The knob turns a follower that acts directly on talons on the arms of the latch bolt. A helical steel wire tension spring that is attached to another talon returns the latch bolt to its protracted position. The operation of the key bolt is protected by concentric wards that are integral with the front and back plates of the lock and by a single lever tumbler with a gate that engages a talon on the key bolt. An arm extends upwards from the tumbler and connects with the same spring that actuates the latch bolt. Rosettes have two exposed screw holes. Escutcheons and covers are keyhole-shaped. These locks are attached with modern machine-made screws (gimlet points), and given their undisturbed context in the Upjohn additions, they were certainly installed in 1849-1850.

2. Hinges

This study of door hinges at the Van Buren house was undertaken as part of the hardware study. It was suspected that several of the doors had been moved during the various remodelings undertaken over the years and that a careful study of hinges and screws would illuminate the changes that had been made. This proved to be the case.

The study proceeded from a simple descriptive survey that recorded hinge type (wrought-iron strap, see IP127; H or HL, see IP128 and 129; cast-iron butt, see IP130; or brass butt), configuration (numbers of knuckles and screw holes), and dimensions (height and maximum width of open leaves), to a grouping by types and configurations and correlation of these groupings with contextual data such as location, panel molding, paint layering, screw type, lock type, and ghosts of former hinges and locks. All the wrought hinges could be attributed to the ca. 1797 original construction of the Van Ness's house, and the brass butt hinges are clearly 20th century work. Therefore, the 19th century changes all swing on interpretation of the cast-iron butt hinges.

The cast-iron butt hinges were found in six different configurations and 18 combinations of configuration and dimension. Each hinge in each group was carefully considered in terms of its context and consistency of its context with other members of the group. This comparison was accomplished by using colored marks on floor plans to reveal the significance of location and corresponding contextual factors.

Two more groups of hinges could be identified immediately by this method. The group of five-knuckle eight-hole 4" by 4" hinges (see IP130) were immediately associated with the Upjohn addition and remodeling of 1849-1850. These hinges occur on doors X04 (X designates doors stored in the house, not hung in door openings), X05, X07, X09, 014, 015, 016, 017, 019, 108, 110, 112, 113, 114, 115, 116, 117, 118, 119, 122, 124, 125, 126, 127, 128, 211, 214, 307, and 309. Although the data for any one door might not warrant this conclusion, the combined evidence does.

A group of five-knuckle ten-hole 5" by 3" hinges were found on doors 102, 103, 104, 107, 136, and 307 (see IP131). All of these, except 307, were in the first floor of the ca. 1797 house, and all but 136 and 307 were attached with handmade screws. This information, combined with the absence of any indications of earlier hinges on these doors, makes a strong case for asserting that these are original ca. 1797 hinges. Door 307 has only one hinge of this type; the other is the type previously associated with the 1849 remodeling work, which strongly indicates that this door was removed from the door 130 area and reused in the attic.

In the same manner it was determined that the remainder of the five-knuckle eight-hole hinges could also be associated with the Upjohn remodeling or later repairs. These hinges are found on doors 008, 016, 109, 118, 201, 202, 217, 303, and 305. Most of the two-knuckle hinges can also be associated with the Upjohn remodeling work. They occur on doors X06, X10, X11, 007, 018, 022, 105, 121, 123, 133, 212,

213, 306, and 308. The context of doors 121 and 123 indicates that they are later alterations. Both are attached with modern screws and have cast-iron rim locks that are also attached with modern screws. (For more information see the previous section.) A group of five-knuckle six-hole hinges seems to be associated with alterations done in 1838-1840 under Van Buren's direction. These hinges are found at doors 132, 205, 206, 216, and 301. Door 301 has probably been reused from an unknown location. Door 131 swings on a unique pair of three-knuckle six-hole hinges. The context of a post-1836 carpenter-type lock, later machine-made screws, and relation to Van Buren stair alterations leads to the conclusion that this is also part of the Van Buren 1838-1840 work.

Door 129 swings on another unique set of hinges--five-knuckle ten-hole 5" by 5" hinges. Oral history provided by the DeProse family indicates that this door and its frame were moved from door 120 during the nursing home use of the house. Another tradition suggests that this door was reused from a church in Kinderhook. The door itself is unique in the house. It is made of either mahogany or walnut, unfinished; with a unique panel molding and segmental top. The frame of door 120 consists of grained paneled jambs with a typical Upjohn-period panel molding. The masonry opening has been cut into the ca. 1797 brickwork on the north side and filled in on the south side. An examination of the head of this opening reveals a brick arch in the original masonry, which springs from a point about 15" south of the present north jamb. A vertical crack in the plaster on the east wall of room 113 and a heavy timber door frame member on the west wall of room 109 indicate the location of the south jamb of the original ca. 1797 door opening. The change in this door opening was obviously necessitated by the Upjohn tower stair.

3. Window Hardware

a. Sash Locks

Two types of sash locks were used historically at Lindenwald. The ca. 1840 windows have "Philadelphia Pattern" sash fasteners (see IP132, 133) identical to those on page 77 of the Illustrated Catalogue of American Hardware of the Russell and Erwin Manufacturing Company, 1865. The ca. 1850 windows had sash fasteners similar to "Judd's Patent No. 3," illustrated on the same page of the Russell and Erwin catalogue (see IP134, 135).

b. Shutter Hardware

Hinges for the historic shutter blinds are offset wrought-iron straps (see IP136) and separate plate-mounted wrought-iron pintles (see IP137). Shutters are held closed by a "drop and pin" set (see IP138, 139) similar to one illustrated on page 149 of the Russell and Erwin catalogue. Two different types of shutter "holdbacks" or "holdfasts" are present: The spring type (see IP140) does not appear in Russell and Erwin; the propeller type (see IP141) is shown as a "wrought iron turn buckle" on page 148 of Russell and Erwin.

On the ca. 1797 interior shutters a brass ring pull (see IP142) is used to pull the shutters out of their pockets. Swivel bars (see IP143, 144) are used to hold the shutters closed.

4. Fasteners
a. Nails

A study of the nails used at Martin Van Buren's house was undertaken for the additional information it could provide on the date and sequence of construction of the different additions and alterations to the house. Nails used in construction can, by their method of manufacture, be placed in a sequence and given a rough date as to period of use. Precise dating information is not always possible; however, similarities between nails in different areas of construction can suggest that two or more separate areas were constructed in the same building campaign. Thus, if the date of construction of one area is known, another area with the same nails can be hypothesized as of the same construction period. This hypothesis can be confirmed or refuted by comparing such other features as plaster and mortar, lath type, shingles, saw marks, screws, hardware, moldings, and paint layering.

For the purposes of this study, nails have been grouped according to their uses --lath nails, shingle nails, roof sheathing nails, common nails, flooring nails, and finish nails. Within these groups they have been subdivided according to the technology of their manufacture--hand wrought, wrought head on cut shank, crude machine-made head on cut shank, early and later types of cut nails, and finally wire nails.

The basic reference used in conducting this study was the American Association for State and Local History's technical leaflet 48, Nail Chronology As An Aid To Dating Old Buildings, by Lee H. Nelson.

(1) Lath Nails

No wrought lath nails have been found in the Martin Van Buren house. The earliest lath nails are cut nails with two-facet handmade heads. Nelson assigns a date of ca. 1790-1810 to this type of nail. Every place that these nails occur in the house is clearly part of the original 1797 construction. They are always found in conjunction with split lath and only on unaltered interior partitions of the main house.

Ca. 1797 lath nails with cut shank, two-facet handmade heads, and diagonal burrs has been found in the following locations:

<u>Artifact Number</u>	<u>Location</u>
009	Room 108 north wall west end
010	Room 108 north wall west end under ghost of baseboard
011	Room 108 north wall at ghost of north-south wall
047	Room 108 south wall, reused stud (nail survives from previous use)

- 048 Room 108 east wall, sash-sawn stud
- 049 Room 105 north wall behind heating register
- 111 Room 210 east wall south end

Two groups of cut lath nails with crude machine-made heads, diagonal burrs, irregular points, and a dramatic reverse taper under the head were found in areas of plaster infill relating to early changes. These nails are distinctly different from the 1797 lath nails, from those used by Van Buren in ca. 1840 work and from the Upjohn's ca. 1850 work. The diagonal burrs and extreme crudeness of the heading operation indicate that they predate the Van Buren work. This hypothesis is confirmed by the context of sample 071, which was taken from the area of door infill on the north wall of room 208. A chair rail was installed across this area and subsequently removed. We have already established that Van Buren removed all the chair rails before installing wallpaper ca. 1840.

Ca. 1815 1-1/4" to 1-3/8" cut lath nails with crude machine-made heads, diagonal burrs, and irregular points are in the following areas:

<u>Artifact Number</u>	<u>Location</u>
071	Room 208 north wall door infill
113	Room 210 east wall infill south of door 216

The lath nails used in ca. 1840 and ca. 1850 construction are all cut nails with burrs on a common side and crude machine-made heads. By trial and error it was determined that two factors (length and point configuration) could be used to separate these samples into groups according to date. The validity of this technique was confirmed by a 100 percent date correlation of samples of known date with the same samples dated on the basis of length and point configuration. The validity is further confirmed by a comparison of the mass of each nail with others in the same group and those in the other group. There is no overlap between the two groups. Furthermore, the ca. 1840 group shows greater variance within the group. This observation is consistent with the following discussion of cut nail technology.

The significance of point configuration is related to an advance in the technology of producing the plate stock from which nails were cut.* Earlier nailplates were produced by passing a bar of iron through a rolling mill until it reached the desired width (determining nail length) and thickness. This process produces a plate whose precise width varied and whose edge profile was generally rounded and irregular.

*The remaining discussion of plate stock is based on a telephone conversation with E. Blaine Cliver, regional historical architect, North Atlantic Regional Office, who is preparing an article on this subject.

Furthermore, the cold rolling process causes the grains of iron and impurities to become hardened and elongated in the direction of rolling. When nails are cut from a plate made in this manner, the elongated grains run perpendicular to the axis of the nail. Because the malleability of the rolled iron in a cut nail is less than that of wrought iron, these nails tend to rupture or fail in bending at a much lower stress than wrought nails, making them unsatisfactory for clinching.

An improvement in the manufacture of iron plate caused by the increase in size and number of rolling mills during the 1820s resulted in the production of a larger plate stock from which ribbons of iron were sheared. This process produced a nail plate or ribbon with a constant width (length of nails) and a sheared edge, giving the resulting nail a sheared point.

Ca. 1840 1-3/8" cut lath nails with crude machine heads, common burrs, and irregular points have been found in the following rooms:

<u>Artifact Number</u>	<u>Location</u>	<u>Wt.</u>
012	Room 108A east wall, north jamb	1.65 g
099 (1-4)	Room 306 ceiling	1.62, 1.53, 1.57, 1.47
100	Room 305 ceiling south of dormer	1.51
109	Room 210 north wall	1.27
116	Room 302 east wall	1.55

Ca. 1850 1-1/8" cut lath nails with crude machine-made heads, common burrs, and sheared points have been identified in the rooms below:

<u>Artifact Number</u>	<u>Location</u>	<u>Wt.</u>
001	Room 002 ceiling	.78, .89
026	Room 305 at opening to 313	.66, .68
078	Room 111 ceiling	.65
082	Room 112 ceiling	.65
087	Room 112 side of partition north of door 127	.66, .67
095	Room 302 west wall at opening to room 309	.66, .72, .72, .53, .73, .59

<u>Artifact Number</u>	<u>Location</u>	<u>Wt.</u>
098	Room 304 north cheek of gable	.73, .81
101	Room 307 at tower	.64, .75, .70, .67, .69
102	Room 307 at door 307	.57, .44, .69, .66, .66
108	Room 210 west wall	.79, .85
114	Room 302 east sloping ceiling	.62
115	Room 302 west wall	.59

Rooms 302, 305, and 306 are not considered to be 1840 contexts (samples 099, 100, and 116) because the lath is circular-sawn and all the other nails from the area are ca. 1850 lath nails. It is possible that Van Buren plastered this area ca. 1840 and extensively remodeled it ca. 1850, but it is more likely that nails acquired but not used for 1840 work were used in 1850. This hypothesis is corroborated by the presence in similar contexts (rooms 302, 304, 305, and 307) of 1850 lath nails (samples 026, 095, 098, 101, 102, 114, and 115).

Three samples of lath nails that do not fit any of the above categories were found. They are 1-1/4" to 1-3/8" long with sheared points. All three contexts are uncertain. Samples 008 and 079 are from opposite sides of the wall between rooms 108A and 109. This wall is associated with the stair that was moved to this location ca. 1840 and significantly altered ca. 1850. Sample 099 (no. 5) was taken from the ceiling of room 306. This context and the other nails in this sample are discussed in the preceding paragraph. This context, the sheared points, and similarity to ca. 1850 shingle nails suggest a ca. 1850 date.

1-1/4" to 1-3/8" cut lath nails with crude machine-made heads, common burrs, and sheared points are in the following rooms:

<u>Artifact Number</u>	<u>Location</u>	<u>Length</u>
008	Room 108A south wall	1-1/4"
079	Room 109 north wall west end	1-3/8"
099 (5)	Room 306 ceiling	1-3/8"

It is significant to note that no modern-type cut lath nails were discovered in our investigation. Common and flooring nails of the modern type were found in both 1839-1840 work and 1849-1850 work.

(2) Shingle Nails

Shingle nails from the original 1797 construction work are virtually indistinguishable from lath nails of the same period. These nails have handmade heads, with burrs on common or diagonal edges and irregular points, and the average length is 1-5/16", with an overall range of 1-1/4" to 1-3/8". The lath nails are the same except all that were examined had diagonal burrs and only one was as long as 1-5/16"; the others were 1-1/16" or 1-1/8". Assuming the 1-5/16" lath nail to be an anomaly, we can say that two-penny nails were used for lath and three-penny nails for shingles (Fontana, Greenleaf, et al. 1962, 28, no. 1-2).

Ca. 1797 two-facet shingle nails with handmade heads have been found at the following sites:

<u>Artifact Number</u>	<u>Location</u>	<u>Burrs</u>	<u>Length</u>
022A	Room 304 north side front gable	common	1-3/8"
022B	Room 304 north side of east gable	diagonal	1-1/4"
025	Room 313, out of context	common	1-5/16"
029-1	Room 306 inverted sheathing board	common	1-5/16"
029-2	Room 306 inverted sheathing board	diagonal	1-5/16"
029-3	Room 306 inverted sheathing board	common	1-3/8"
066	Room 304 north side of east gable	diagonal	1-1/4"
084-1	Exterior, west gable, south valley, under flashing	common	1-1/4"

Ca. 1850 1-3/8" to 1-5/8" cut shingle nails with crude machine-made heads, burrs on edges of a common side, and sheared points are in the locations below:

<u>Artifact Number</u>	<u>Location</u>	<u>Length</u>
017	South peak, out of context	1-1/2"
018 (2-4)	South peak, out of context	1-1/2"
039	Attached metal liner to cornice molding/gutter found in yard	1-1/2"

<u>Artifact Number</u>	<u>Location</u>	<u>Length</u>
083	Under west gable south side	1-7/16"
085 (1-7)	West gable south side, attached valley flashing	1-3/8"-1-5/8"
118 (1-4)	Main roof, attached circular-sawn shingles used as shims	1-7/16"

One nail (sample 018, no. 1) that fits none of the above categories was found on an inverted roof sheathing board. It is 1-1/2" long, with burrs on diagonally opposite edges, an irregular point, and a dramatic reverse taper at the head. All of these characteristics correspond to ca. 1815 lath nails, so this artifact is interpreted as an indication of roof repairs before Van Buren's purchase of the house.

With a little manipulation of the data, the cut shingle nails with crude machine-made heads can be separated into a group with irregular points and one with sheared points that correspond to the 1840-1850 grouping of lath nails. Sample 083 is the only nail whose configuration and context does not fit the above grouping hypothesis. It has a sheared point, but its context (the sloped roof under the 1850 west gable) is clearly pre-1850. Unless other contradictory evidence is discovered, this artifact will be treated as an unexplained anomaly, especially in light of the fact that four other nails from the same context (sample 065) have irregular points.

Ca. 1840 1-3/8" to 1-5/8" cut shingle nails with crude machine-made heads, burrs on edges of a common side, and irregular points have been found as follows:

<u>Artifact Number</u>	<u>Location</u>	<u>Burrs</u>	<u>Length</u>
028	Room 306	common	1-1/2"
038	Discarded rived shingle (pre-Van Buren [E.B.C.])	common	1-3/8"
065 (1-4)	Under west gable south side	common	1-1/2"
084 (2)	West gable south side	common	1-5/8"

(3) Roof Sheathing Nails

One wrought sheathing nail has been collected from the 1797 roof surface now under the west central gable. Wrought common nails are indistinguishable from this sheathing nail; therefore, they will be discussed together in the following section.

The only cut sheathing nails collected to date are from the west gable, added in 1849-1850. They are 3" long (ten penny) and indistinguishable from modern cut nails. Though used for a different purpose, they are of the same form as the common nails to be considered next and will be cataloged with them for convenience.

(4) Common Nails

Common nails are generally used to join one framing member to another. Therefore, they are generally necessary to the integrity of the structure, and their removal for analysis is not advisable. However, one does occasionally find a common nail that is superfluous, only partially driven, bent, or unused. Consequently, the context of the sample is often subject to doubt. None of the samples in this study can be considered to be free of such doubt. Sample number 062 comes from the most certain context. The two nails were found loose inside the wall below a stovepipe opening that was later sealed. Obviously they were deposited there before the opening was sealed, but it can further be proved that they were deposited either when the stovepipe opening was made or before. The nails have bits of the plaster that was used to seal around the stovepipe adhering to 062 comes from the most certain context. The two nails were found loose inside the wall below a stovepipe opening that was later sealed. Obviously they were deposited there before the opening was sealed, but it can further be proved that they were deposited either when the stovepipe opening was made or before. The nails have bits of plaster that was used to seal around the stovepipe adhering to them. The nail themselves are of the modern type, but with irregular points. According to Nelson, such nails were probably not available until the late 1850s. Thus the date of creation of the stovepipe hole can be bracketed between the late 1830s and the installation of the central heating system ca. 1855-1860. The most likely time during that period is the 1840 remodeling done by Van Buren. Additional light may be cast on this area by the plaster tests that remain to be analyzed.

Three nails were removed from exposed contexts where they could have been applied at any date after the date when such nails were first manufactured. All three are modern-type cut nails with sheared ends--a type that was manufactured from the late 1830s to the present. Only one of these nails actually performed a function in a datable context. Sample 002 attached a lath nailer to one of the beams in room 003. This ceiling was installed after the stair between rooms 003 and 105 was removed (ca. 1840) and before the central heating system was installed (ca. 1855-1860). Plaster analysis may make more definite dating possible. Sample 023 was found loose in the attic--a worthless context.

Various kinds of wrought common nails have been identified in the following locations:

<u>Artifact Number</u>	<u>Location</u>	<u>Head</u>	<u>Use</u>	<u>Length</u>	<u>Context</u>
016	Room 309 floor joint/ lath nailer	rose	common	2-3/4"	1797
024	Room 313	2-lobe	?	2-5/16"	loose
030(2)	Room 306	rose	common	2-7/16"	doubtful
032	1797 roof above room 309	2-lobe	sheath- ing	2-11/16"	1797
033	Room 309, attached blocking to joist	rose	common	3"	1797
110	Door 216 stud at south jamb	rose	common	3"	1840 (reused)

<u>Artifact Number</u>	<u>Location</u>	<u>Length</u>	<u>Point</u>	<u>Context</u>
002	Room 003 ceiling lath nailer	3-1/4"	sheared	doubtful
021	Room 303 south side of dormer in stud	?	missing	doubtful
023	Room 304 south side central dormer	4-11/61"	irregular	loose
030-3	Room 306 north wall, fourth post from east	3-9/16"	sheared	doubtful
062	Room 208 stovepipe opening to room 205	2-7/16"	irregular	firm 1838-55
117	Roof, northwest quadrant, attached sheathing to intermediate brace	broken	missing	

(5) Flooring Nails

The only flooring nails collected from 1797 floors came from Room 210. They are wrought T-head nails ranging from 2-5/8" to 3" long. Some of the attic (third floor) floorboards are face-nailed with nails that have wrought heads. The shanks could not be examined, but it seems most likely that they would be wrought, matching the common and sheathing nails of the same period.

Cut flooring nails are neatly divided into two periods--Van Buren (1840) and Upjohn (1850)--on the basis of the nailheads. Van Buren flooring in patched areas of rooms 105 and 206 is attached with modern-type cut nails with standard machine-made heads and irregular points. Upjohn flooring is attached with modern-type cut nails with small swelled heads and sheared points.

Ca. 1840 Van Buren flooring nails with perfected machine-made heads and irregular points are in the following rooms:

<u>Artifact Number</u>	<u>Location</u>	<u>Length</u>
054	Room 105 patch over "basement stair"	2-7/8"
067	Room 206 west portion closure of stair opening	2-1/2"

Ca. 1850 Upjohn flooring nails with swelled heads and sheared points have been found as follows:

<u>Artifact Number</u>	<u>Location</u>	<u>Length</u>
020	Room 213 east end	3"
027	Room 313, loose	3"
034	Gutter liner near tower	2-7/8"
096	Room 213	3"

A second layer of flooring was installed on top of the Upjohn flooring in room 112. It was attached with headless modern cut nails with sheared points. The heads show the effects of being struck with a nail set (081). Room 114 also had a later flooring over the Upjohn surface. It was attached with wire nails (080).

(6) Finish Nails

The finish nails collected from the Van Buren house fall into five categories: T-head wrought nails, three types of L-head cut nails, and modern swelled-head cut nails. The wrought nails occur in 1797 work. Samples 030(1) and 103 were in unreliable contexts. Sample 036 may be associated with 1797 or 1849-1850 work.

Wrought T-head finish nails have been found in three different areas, as follows:

<u>Artifact Number</u>	<u>Location</u>	<u>Length</u>
030-1	Room 306 post on north wall	2-5/16"
036	Southeast dormer under subsill	? from rosehead
103	Room 301 reused 1797 architrave	2-1/4"+from rosehead

The three types of L-head cut nails found in the Van Buren house are those with hand-hammered heads, those that are completely machine cut with rounded corners, and those that are completely machine cut with sharp corners. Samples 061 and 097 with handmade heads were both used in 1797 work. Samples 006 and 007 (completely machine cut with round corners) are both from an early but uncertain context--shelf ledger strips in a closet, room 107. (Paint layering indicates a 1797 date for these shelves.) Samples 051 and 052 (completely machine cut with sharp corners) are both from room 105, one from the north wall baseboard near the center and the other from the top of the architrave of door 108. These are both contexts where the nails could have been applied at any time after their earliest date of manufacture, which Lee Nelson presents as 1810.

Modern-type cut finish nails (with swelled heads) were found in the casing of door 120 and in the baseboard on the west wall of room 105 south of door 108. The nails in door 120 (076) are identical to those used in flooring in the Upjohn period (artifacts 020, 027, and 096). Style, masonry, paint layering, and hardware all confirm an 1850 period for this work. Nails 050 and 053 are similar, but their heads have been deformed and the points are missing. Nevertheless, the similarity is strong enough to suggest that this section of baseboard was installed in 1850. The date fits well with the hypothesis that the neighboring stair was realigned by Upjohn. This hypothesis should be confirmed by paint studies before a definite conclusion is drawn.

The trim for door 216 is assembled and attached with modern-type cut nails which have burrs on edges of a common side and irregular points (107). Although used as finish nails, they have full heads and should be classified as common nails. Nelson assigns a date of late 1830s to early 1840s to such nails. This evidence conflicts with that of samples 071 and 113, which suggest an earlier date for this opening. Evidence from the lock and hinge studies support the hypothesis that Van Buren altered the door and casing which had previously been moved to this area (as indicated by lath nails from adjacent plaster infill).

b. Screws

All four identifiable types of screws were found at Lindenwald. These types are handmade, early machine made, later machine made, and modern (or pointed).

Handmade screws were manufactured throughout the 18th century, with some probable persistence into the 19th century. They are characterized by irregularities of shank diameter, thread

spacing and thickness, and head placement and by evidence of hand filing. Heads may be round or flat, and points may be blunt or sharp.

Early machine-made screws were manufactured in the lath 18th and early 19th centuries. They generally show evidence of some hand finishing, but threads are of regular thickness and spacing and the shank within the threaded area is of uniform size. Heads are generally flat and points are blunt.

Later machine-made screws were manufactured from the 1800s to the 1840s. They are characterized by uniformity of threads, thread spacing, and shank diameter. The surface of the screws shows parallel striations from the cutting edge of the machine tools used in the manufacturing process. Heads may be round or flat, and points are blunt.

Modern (or pointed) screws have been manufactured from the 1840s to the present. They are similar to later machine-made screws, except that the shank and threads taper to a point.

No separate study of screws has been conducted for this project. All screws are discussed in the context of the hardware they attached.

E: Door and Window Schedules

Key: Door Schedule

Panel Moldings (see section VI. B.)

Number	Date	Locations
P1	1797	doors 101 & 305
P2	1797	doors 103, 104, 107, 307
P3	1797	doors 103, 104, 307
P4	1797	doors 102, 132, 136
P5	ca. 1840	door 133
P6		door 105
P7	1797	doors 134, 135, 303
P8	ca. 1840	door 108
P9	1797	doors 201, 202, 203, 204, 207, 209, 210, 215, 217
P10		door 206
P11		door 216
P12		door 304
P13		door 301
P18	ca. 1849	door 109, 112, 113, 115, 116, 123, Jambs: 122, 125, 126, 128, 214, 309
P19	ca. 1849	door 110, 114, 117, 118, 119, 120, 122, 124, 125, 126, 127, 128, 211
P21	ca. 1849	door 127 (Jambs)
P22	ca. 1849	door 121

Architrave Moldings (see section VI.B.)

Number	Date	Locations
A1	1797	doors 101, 102, 103, 107, 134, 135, 136
A2	1797	doors 103, 104, 107, 134, 135, 137, 211, 307
A3	1797	door 105
A4	1797	door 203, 204, 207, 209, 210, 215
A5	ca. 1804-1824	door 202, 206
A6	ca. 1804-1824	door 201, 217
A7	ca. 1804-1824	door 216
A8	post 1862	door 205
A9	ca. 1849	doors 112, 114, 115, 118, 119, 125, 126, 127, 128
A10	ca. 1849	doors 007, 008, 011, 012, 013, 014, 015, 016, 017, 019, 020, 021, 110, 111, 113, 114, 115, 117, 118, 122, 123, 124, 125, 127, 138, 211, 212, 214, 309
A11	ca. 1849	door 120, 128

Hinges (see section VI.D.2.)

Number	Date	Locations	Description
H1	1797		wrought iron
H2	1797		5-knuckle 10-hole 5" x 3" butts
H3	1849		5-knuckle, 6- or 8-hole butts
H4	20th century		brass butts

Fasteners (see section VI.D.4.)

Number	Date	Locations	Description
F1			wrought nail
F2			handmade screw
F3			early machine-made screw
F4			later machine-made screw
F5			modern-type (pointed) screw

Locks (see section VI.D.1.)

Number	Date	Locations	Description
L1			stock lock
L2			sheet-iron rim lock
L3			sheet-iron rim lock "Green & Broad"
L4			carpenter-type "J. Walker"
L5			carpenter-type "No. 60 Improved"
L6			cast-iron rim lock "P.M. & Co."
L7			cast-iron rim lock "D.M. & Co."
L8			cast-iron rim lock miscellaneous
L9			sheet-iron mortise lock
L10			cast-iron mortise lock
L11			ghost of rim lock
L12			cast-iron thumbblatch
L13			wrought thumbblatch

DOOR NO.	REMARKS	HEIGHT	WIDTH	THICKNESS	NUMBER OF PANELS	PANEL Moulding	ARCHITECTURAL Moulding	HINGES	FASTENERS	LOCKS	DATE
101	Dutch Door, ORIG. KNOCKER	7'-11"	3'-10 ³ / ₄ "	1 ³ / ₄ "	6/2	P1	A1	H1		L9	1797
102		6'-11 ³ / ₈ "	3'-3 ¹ / ₄ "	1 ³ / ₄ "	6	P4	A1	H2	F2	L9	1797
103		6'-11 ¹ / ₈ "	3'-3 ³ / ₈ "	1 ³ / ₄ "	6	P2, P3	A1, A2	H2	F2	L9	1797
104		6'-10 ³ / ₄ "	3'-3 ¹ / ₄ "	1 ³ / ₄ "	6	P2, P3	A2	H2	F2	L9	1797
105	DOUBLE DOOR 1849 IN 1797 OPENING	6'-7 ⁵ / ₈ "	2x(1'-8 ¹ / ₂ "	1"	2 EACH	P6	A3	H3	F4	L6	1797-1849
106		6'-11 ³ / ₈ "	2'-8 ³ / ₈ "	1 ³ / ₄ "	6	—	—	H4	F5	L10	20TH CENT.
107		6'-11 ³ / ₈ "	3'-3 ³ / ₈ "	1 ³ / ₄ "	6	P2	A1, A2	H2	F2	L9	1797
108	1797 OPS, C. 1840 DOOR, 1849 WEST TRIM	7'-10 ¹ / ₂ "	3'-8 ³ / ₈ "	1 ⁵ / ₁₆ "	8	P8	A1, A7	H3	F4	L9	1797 TO 1849
109	DOUBLE DOOR ARCHED OPENING	8'-11 ¹ / ₂ "	4'-0"	1 ³ / ₄ "	3 EACH	P18	A9	H3	F4	L10	1849
110		6'-11 ¹ / ₂ "	2'-11 ³ / ₄ "	1 ³ / ₄ "	4	P19	A10	H3	F4	L12	1849
111	OPENING ONLY	7'-0"	3'-0 ³ / ₈ "				A10	H3			1849
112	ARCHED OPENING	7'-3 ⁵ / ₈ "	2'-11 ¹ / ₈ "	1 ³ / ₄ "	4	P18	A9	H3	F4	L10	1849
113		6'-11 ¹ / ₄ "	3'-0"	1 ³ / ₄ "	4	P18	A10	H3	F4	L10	1849
114		6'-11 ¹ / ₂ "	3'-0"	1 ³ / ₄ "	4	P19	A9, A10	H3	F4	L10	1849
115		6'-10 ³ / ₄ "	2'-11 ³ / ₄ "	1 ³ / ₄ "	4	P18	A9, A10	H3	F4	L9	1849
116		6'-7"	2'-7 ¹ / ₂ "	1 ³ / ₄ "	4	P18	—	H4	F5	—	POST-1890
117		6'-11 ¹ / ₄ "	2'-11 ³ / ₄ "	1 ³ / ₄ "	4	P19	A10	H3	F5	L10	1849
118	ENFOLD (BELONGS AT D138)	6'-11 ¹ / ₈ "	18 ¹ / ₂ " x 17 ¹ / ₂ "	1 ³ / ₄ "	2 EACH	P19	A9, A10	H3	F5	L10	1849
119		6'-11 ³ / ₄ "	2'-11 ³ / ₄ "	1 ³ / ₄ "	4	P19	A9	H3	—	L10	1849
120	DOOR AND ARCHITECTURE AT D129	6'-4 ³ / ₄ "	2'-2 ³ / ₄ "				A11				
121	6 LIGHTS	6'-9 ³ / ₄ "	2'-10"	1 ³ / ₈ "	2	P22	—	H3	F5	L7	POST 1862
122		6'-11 ¹ / ₄ "	2'-7 ³ / ₄ "	1 ³ / ₄ "	4	P19	A10	H3	F5	L10	1849
123				1 ³ / ₄ "	4	P18	A10	H3	F5	L8	POST 1890
124	MOVED DOOR	6'-10"	2'-11 ⁵ / ₈ "	1 ³ / ₄ "	4	P19	A10	H3, H5	—	L10	1849, POST 1890
125		6'-11 ³ / ₈ "	2'-7 ¹ / ₄ "	1 ³ / ₄ "	4	P19	A9, A10	H3	—	L10	1849
126		6'-10 ³ / ₄ "	2'-8 ³ / ₄ "	1 ³ / ₄ "	4	P19	A9	H3	F4	L10	1849
127		6'-11"	2'-6 ³ / ₄ "	1 ³ / ₄ "	4	P19	A9, A10	H3	F5	L10	1849
128	1 LIGHT 2'-4 ¹ / ₂ " x 3'-9"	6'-11 ¹ / ₈ "	2'-11 ³ / ₄ "	1 ³ / ₄ "	2	P19	A9, A11	H3	F4	L9	1849
129	ARCH TOP DOOR FROM D120	6'-4 ³ / ₄ "	2'-2 ³ / ₄ "	2"	2	—	—	—	F3	L10	?
130	1849 DOOR IN 20TH CENT. FRAME	6'-11"	2'-11 ³ / ₄ "	1 ³ / ₄ "	4	—	—	H4	F5	L10	
131		5'-11"	3'-2 ³ / ₄ "	1 ³ / ₈ "	4	FLAT		—	F4	L4	c. 1840
132	9 LIGHTS 7 ¹ / ₂ " x 9 ¹ / ₂ "	6'-5 ¹ / ₂ "	2'-8 ⁵ / ₈ "	1 ³ / ₄ "	2	P4	—	—	F4	L10	
133	DOUBLE	6'-11"	2x 2'-0"	1 ³ / ₄ "	3 EACH	P5	—	—	F4	L9	c. 1840
134		6'-5 ¹ / ₄ "	2'-8 ¹ / ₄ "	1 ³ / ₄ "	5	P7	A1, A2	H1	F2	L9	1797
135		6'-5 ¹ / ₄ "	2'-8 ¹ / ₄ "	1 ¹ / ₄ "	5	P7	A1, A2	H1	F2	L9	1797
136		6'-11 ³ / ₈ "	3'-3 ¹ / ₄ "	1 ³ / ₄ "	6	P4	A1	H2	F2	L9	1797
137	OPENING ONLY						A2	H1	F2		1797
138	OPENING DOOR 118 BELONGS	6'-11 ³ / ₈ "	3'-0"				A10				1849

DOOR No.	REMARKS	HEIGHT	WIDTH	THICKNESS	NUMBER OF PANELS	PANEL MOLDING	ARCHITRAVE MOLDING	HINGES	FASTENERS	LOCKS	DATE
201		6-8"	3-3 1/2"	1 1/4"	6	P9	A6	H3	F3	L3	1797
202	TRANSOM	6-7 5/8"	3-2 5/8"	1 1/4"	6	P9	A5	H3	F3	L8	1804-1824
203		6-8 1/4"	3-2 3/4"	1 1/4"	6	P9	A4	H1	-	L3	1797
204		6-8"	3-4 1/2"	1 1/4"	6	P9	A4	H1	-	L3	1797
205		6-8"	2-10"	1 1/4"	6	-	A8	H3	F5	L4	POST 1862
206		6-7 1/2"	3-2"	1 1/4"	6	P10	A5	-	-	L4	?
207		6-8"	3-2"	1 1/4"	6	P9	A4	H1	-	-	1797
208											ZOTH CENT.
209		6-8"	3-3 3/8"	1 1/4"	6	P9	A4	H1	-	L3	1797
210		6-8 1/4"	3-1 1/8"	1 1/4"	6	P9	A4	H1	-	L2	1797
211		5-10 1/4"	2-10 3/4"	1 1/2"	4	FLAT, P19	A10, A2	H3	-	L10	1849
212		5-10 1/4"	2-3 3/8"	1 7/8"	4	FLAT	A10	-	F4	L8	1849
213	DOUBLE DOORS	5-7 5/8"	2 x 2-0"	1"	2 EACH	FLAT	-	H3	F4	-	1849
214		5-11"	2-2 3/4"	1 1/2"	4	FLAT, P18	A10	H3	F4	L8	1849
215		6-8"	3-4 1/4"	1 1/4"	6	P9	A4	H1	-	L3	1797, 1840
216	MOVED 1-1" NORTH	6-7 3/4"	2-8"	1 1/2"	6	P11	A7	H3	F4	L5	1797, 1840
217		6-8"	3-3 3/8"	1 1/4"	6	P9	A6	H3	F3	L3	1797
218	ARCHED OPENING	10-1"	8'-1 1/2"								
219	INFILLED OPENING	7-1 1/2"	4-1 1/2"								
301		6-0 3/8"	2-6"	1 1/4"	6	P13	-	H3	F4	L1	1797, 1849
302	1849 WINDOW OPENING										2, 1960
303		6-1 3/8"	2-11 1/2"	1 1/4"	6	P7	-	H3	F4	L6	1797, 1849
304		5-11 1/4"	2-1 3/8"	1"	2	P12	-	H1	-	L12	?, 1849
305		6-1 1/2"	2-7 3/8"	1 5/8"	6	P1	-	H3	F3, F4	L12	1797, 1849
306		6-3 3/8"	2-6 3/4"	1 1/4"	4	FLAT, FEATHERED	BOARD	H3	F4	-	?, 1849
307		6-5"	2-11"	1 3/4"	6	P2, P3	A2	H2, H3	-	L12	1797, 1849
308		5-11 1/8"	2-5 1/2"	7/8" to 1 3/4"	2 BRATTENS	2 BOARDS	BOARD	H3	-	-	?, 1849
309		6-0 1/4"	2-4 3/4"	1 1/2"	4	P18	A10	H3	F4	L8	1849

Key: Window Schedule

Type

T1 vertical siding sash
T2 casement
T3 fixed
T4 infilled
T5 multipaned "picture" window

Muntin Profile

Number	Date	Locations
M1	1797	
M2	?	D132
M3	ca. 1840	
M4		D202
M5	1849	

Exterior Molding

Number	Date
E1	1797
E2	1849

Interior Architraves (see section VI.B.)

Number	Date	Location
A1	1797	103, 104, 128, 126, 127, 129, 101 102, 105, 106, 107, 108
A2	1797	109, 110, 125
A4	1797	201, 202, 203, 205, 206, 207, 208, 209, 210, 211, 217, 218
A9	1849	121, 122, 123, 124
A10	1849	010, 011, 012, 013, 014, 015, 016, 017, 018, 019, 025, 113, 114, 115, 116, 117, 118, 119, 120, 301, 302, 303, 305, 307, 311, 312, 313, 314, 315, 401, 402, 403, 212, 215, 216

Interior Shutters

Number	Description
I1	iron bar
I2	hinged shutter
I3	rolling shutter

Shutter Panel Moldings (see section VI.B.)

Number	Date	Location
P14		
P15		
P16		
P20	1849	111, 112

Exterior Features

X1	shutter blind
X2	iron bar
X3	window well

WINDOW SCHEDULE

WINDOW NO.	REMARKS	TYPE	ROUGH	OPENING	LIGHTS		MUNTIN PROFILE	EXTERIOR MOLDING	INTERIOR ARCHITECTURE	INTERIOR SHUTTERS		EXTERIOR FEATURES
			HEIGHT	WIDTH	NUMBER	SIZE				TYPE	MOLDING	
001	PRESENT	T3	1-2"	3-4"	3	9"X11"	—	—	—	I	I	
001	ORIGINAL	T2	2-1"	3-4"						I	I	
002	SAME AS 001									I	I	
003		T2	2-5 1/2"	2-9"	6	7"X9"	M1	E1	—	I	I	
004		T2	2-5 1/2"	2-9"	6	7"X9"	M1	E1	—	I	I	
005	SAME AS 001									I	I	
006	" " "									I	I	
007	DOUBLE CASEMENT	T2	2-4 1/8"	3-6 3/4"	4 EACH	8"X10"	M5	—	—	I	I	
008		T2	1-7 1/2"	2-10"	1	10"X24"	—	—	—	—	—	
007	3-6" ABOVE FLOOR	T4	2-6"	1-8 1/2"						—	—	
010	PRESENT	T2	1-3 1/2"	1-11 3/4"	1	12"X20"	—	—	—	—	—	
010	ORIGINAL		1-8"	2-3 1/2"						—	—	
011	LOWER SASH IS REPLACEMENT	T1	4-4 3/4"	3-2 3/4"	6/6		M5	E2	A10	—	—	
012	PAIR WITH W013	T1	4-10"	2-2 1/4"	4/4	10"X12"	M5	E2	A10	—	—	X2, X3
012	" " W012	T1	4-10"	2-2 1/4"	4/4	10"X12"	M5	E2	A10	—	—	X2, X3
014		T1	4-10"	3-3 5/8"	8/8	9"X12"	M5	E2	A10	—	—	X2, X3
015		T1	4-10"	3-8 1/2"	8/8	9"X12"	M5	E2	A10	—	—	X2, X3
016	PAIR WITH W017	T1	4-10"	2-2 1/4"	4/4	10"X12"	M5	E2	A10	—	—	X2, X3
017	" " W016	T1	4-10"	2-2 1/4"	4/4	10"X12"	M5	E2	A10	—	—	X2, X3
018		T1	4-10"	3-8 1/2"	8/8	9"X12"	M5	E2	A10	—	—	X2, X3
019		T1	4-9 1/8"	3-8 1/2"	8/8	9"X12"	M5	E2	A10	—	—	X2, X3
020		T2	2-5"	2-10"	6	7"X9"	M1	TIMBER FRAM.	TIMBER	—	—	—
021	SASH MISSING, FORMER DOOR		FRAME 1-11 1/2"	3-0 1/2"	—	—	—	A10	TIMBER FRAME	—	—	—
022	SASH MISSING	T2	2-5 3/4"	2-9"	—	—	—	TIMBER PEG	WOOD FRAME	—	—	—
023	SASH MISSING	T2	2-5"	2-9"	—	—	—	"	"	—	—	—
024	SASH MISSING, NOW AIR RETURN	T2	2-5"	2-9"	—	—	—	"	"	—	—	—
025	SASH MISSING	T1	4-8"	2-3 3/4"	—	—	—	A10	A10	—	—	—
101		T1	6-6"	3-9 1/2"	6/6	18 7/8"X13 1/8"	M3	E1	A1	I2	?	X1
102		T1	6-6"	3-9"	6/6	" "	M3	E1	A1	I2	?	X1
103	SIDELIGHT	T3	5-1 1/2"	1-10 5/8"	15	VARIABLES	M3	E1	A1	I2	?	—
104	"	T3	5-1 1/2"	1-10 5/8"	15	VARIABLES	M3	E1	A1	I2	?	—
105		T1	6-6"	3-9 1/8"	6/6	13 7/16"X18 7/16"	M3	E1	A1	I2	?	X1
106		T1	6-6"	3-9"	6/6	" "	M3	E1	A1	I2	?	X1
107		T1	6-6"	3-9"	6/6	" "	M3	E1	A1	I2	?	X1
108		T1	6-6"	3-9"	6/6	" "	M3	E1	A1	I2	?	X1
109		T1	6-6"	3-9"	6/6	" "	M3	E1	A2	I2	?	X1
110		T1	6-6"	3-9"	6/6	" "	M3	E1	A2	I2	?	X1
111	SIDELIGHT & 1/2 ARCH'D TRANSOM	T3	10-8"	1-6"	7	12"X19"	—	E2	A9	I2	P20	—
112	" " " " " "	T3	10-8"	1-6"	7	12"X19"	—	E2	A9	I2	P20	—
113		T1	6-7 1/2"	3-2 1/2"	6/6	12"X18"	M5	E2	A10	I3	?	—
114		T2	6-8"	1-4 1/4"	4	13"X18"	M5	E2	A10	—	—	—

WINDOW SCHEDULE (CONT.)

WINDOW No	REMARKS	TYPE	ROUGH OPENING		LIGHTS		MUNTIN PROFILE	EXTERIOR MOUNTING	INTERIOR ARCHITRAVE	INTERIOR SHUTTERS		EXTERIOR FEATURES
			HEIGHT	WIDTH	NUMBER	SIZE				TYPE	MOULDING	
115		T2	6'-8"	1'-4 1/2"	4	13" X 18"	M5	E2	A10	-	-	-
116		T1	6'-8"	3'-2 3/8"	6/6	12" X 18"	M5	E2	A10	I3	?	-
117		T1	6'-8 1/2"	3'-2 3/8"	6/6	12" X 18"	M5	E2	A10	I3	?	-
118	PRESENTLY COMBINED	T3	4'-1 1/2"	6'-4 1/2"	24 (4X6)	12" X 12"	-	E2	A10	REMOVED	?	-
119												
118	HISTORIC	T1	6'-8"	2'-4"	4/4	12" X 18"	M5	E2	A10	I3	?	-
117	HISTORIC	T1	6'-8"	2'-4"	4/4	12" X 18"	M5	E2	A10	I3	?	-
120		T1	6'-8 1/2"	3'-2 1/2"	6/6	12" X 18"	M5	E2	A10	I3	?	-
121		T1	6'-9 1/2"	3'-6"	6/6	12" X 18"	M5	E2	A9	I3	?	-
122	PRESENTLY COMBINED	T3	4'-1"	6'-4"	24 (4X6)	12" X 12"	-	E2	A9	I2-DISABLED	?	-
123												
122	HISTORIC	T1	6'-8"	2'-4"	4/4	12" X 18"	M5	E2	A9	I2	?	-
123	HISTORIC	T1	6'-8"	2'-4"	4/4	12" X 18"	M5	E2	A9	I2	?	-
124		T1	6'-8 1/2"	3'-2 1/2"	6/6	12" X 18"	M5	E2	A9	I3	?	-
125		T1	6'-6"	3'-9"	6/6	13 1/2" X 18 3/4"	M3	E1	A2	I2	?	-
126		T1	6'-6"	3'-9"	6/6	"	M3	E1	A1	I2	?	-
127		T1	6'-6"	3'-9"	6/6	"	M3	E1	A1	I2	?	-
128		T3	5'-1"	1'-10 1/2"	15	VARIES	M3	A9	A1	I2	?	-
129		T3	5'-1"	1'-10 3/8"	15	VARIES	M3	A9	A1	I2	?	-
130	OPENING TO SKYLIGHT SHAFT											
131	ROUND	T3	1 1/2" DIA.		1	9 1/2" DIA.	-	A10	A10	-	-	-
132		T3	1 1/2" DIA.		1	9 1/2" DIA.	-	A10	A10	-	-	-
201		T1	6'-7 3/8"	4'-1"	6/6	13 1/2" X 18 1/2"	M3	E1	A4	I2	?	-
202		T1	6'-7 3/8"	4'-1"	6/6	"	M3	E1	A4	I2	?	-
203	SIDELIGHT	T1	4'-6 1/2"	2'-0 1/2"	9/9	VARIES	M3	E1	A4	-	-	-
204	ARCHED (TOP SASH - 1797)	T1	7'-4"	3'-9 1/2"	18/6	10" X 12" VARIES	M1, M3	E1	A4	-	-	-
205	SIDELIGHT	T1	4'-6 1/2"	2'-0 1/2"	7/9	VARIES	M3	E1	A4	I2	?	-
206		T1	6'-7 3/8"	4'-1"	6/6	13 1/2" X 18 1/2"	M3	E1	A4	I2	?	-
207		T1	6'-7 3/8"	4'-1"	6/6	"	M3	E1	A4	I2	?	-
208		T1	6'-7 3/8"	4'-1"	6/6	"	M3	E1	A4	I2	?	-
209		T1	6'-7 3/8"	4'-1"	6/6	"	M3	E1	A4	I2	?	-
210		T1	6'-7 3/8"	4'-1"	6/6	"	M3	E1	A4	I2	?	-
211		T1	6'-7 3/8"	4'-1"	6/6	"	M3	E1	A4	I2	?	-
212	CONVERTED TO BOOKSHELF	-	6'-7"	4'-1"	-	-	-	-	A11	-	-	-
213	LATER SASH ROUND HEAD	T3	4'-11 1/2"	4'-0"	9	14" X 18"	-	-	-	-	-	-
214		T3	2'-4" DIA.		4	1 1/2" QUADRANT	M3	E2	-	-	-	-
215		T1	6'-8"	2'-0"	4/4	10" X 18"	M5	E2	A11	I2	?	-
216		T1	6'-8"	2'-0"	4/4	10" X 18"	M5	E2	A11	I2	?	-
217		T1	6'-7"	4'-1"	6/6	13 1/2" X 18 1/2"	M3	E1	A4	I2	?	-
218		T1	6'-7"	4'-1"	6/6	"	M3	E1	A4	I2	?	-

WINDOW SCHEDULE (CONT'D.)

Window No.	REMARKS	TYPE	ROUGH OPENING		LIGHTS		MUNTIN PROFILE	EXT. DR. MOLDING	INTERIOR ARCHITRAVE	INTERIOR FINISHES		EXTERIOR FEATURES
			HEIGHT	WIDTH	NUMBER	SIZE				TYPE	MOLDING	
301		T1	5'-10 1/2"	2'-10 1/2"	6/6	10" X 15"	M5	EZ	A10	-	-	-
302	CHANGED TO DOOR C 1960	T1	5'-11"	2'-3 3/4"	4/4	12" X 15"	M5	EZ	A10	-	-	-
303		T1	5'-9"	2'-11"	6/6	10" X 15"	M5	EZ	A10	-	-	-
304	BRICKED UP	T4										
305		T1	6'-5 3/4"	2'-3 1/2"	4/4	12" X 16"	M5	EZ	-	-	-	-
306	BRICKED UP	T4										
307		T1	5'-10"	2'-3 3/4"	4/4	12" X 15"	M5	EZ	A10	-	-	-
308		T3	1'-9"	6'-9"	6 (HOR.)	12" X 16"	M5	-	-	-	-	LATER STORM
309		T3	1'-9"	6'-9"	6 (HOR.)	12" X 16"	M5	-	-	-	-	LATER STORM
310		T3	1'-9"	6'-9"	6 (HOR.)	12" X 16"	M5	-	-	-	-	LATER STORM
311		T2	2'-11 5/8"	9 3/4"	3 (VERT.)	6 1/2" X 10"	M5	EZ	A10	-	-	-
312		T2	3'-9 3/8"	10 1/8"	4 (VERT.)	6" X 9 3/4"	M5	EZ	A10	-	-	-
313		T2	3'-9 3/8"	10 1/8"	4 (VERT.)	6" X 9 3/4"	M5	EZ	A10	-	-	-
314		T2	3'-9 3/8"	10 1/8"	4 (VERT.)	6" X 9 3/4"	M5	EZ	A10	-	-	-
315		T2	5'-2 3/4"	1'-3 3/8"	3 (VERT.)	12" X 18 1/2"	M5	EZ	A10	-	-	-
316	BRICKED UP	T4										
317	BRICKED UP	T4										
401		T2	3'-9 1/2"	10"	4 (VERT.)	6" X 10"	M5	EZ	A10	-	-	-
402		T2	3'-9 1/2"	10"	4 (VERT.)	6" X 10"	M5	EZ	A10	-	-	-
403		T2	3'-9 1/2"	10"	4 (VERT.)	6" X 10"	M5	EZ	A10	-	-	-
501		T3	8'-1"	1'-4"	5 (VERT.)	12" X 18"	M5	EZ	-	-	-	-
502		T3	8'-1"	1'-4"	5 (VERT.)	12" X 18"	M5	EZ	-	-	-	-
503		T3	8'-1"	1'-4"	5 (VERT.)	12" X 18"	M5	EZ	-	-	-	-
504		T3	8'-1"	1'-4"	5 (VERT.)	12" X 18"	M5	EZ	-	-	-	-

F. Mortar and Plaster Studies

An analysis of mortar and plaster samples was undertaken to learn more about the composition of the mixes used during various periods of construction, the consistency of those mixes from one location to another within the same construction period, and the association of samples of unknown dates with known samples.

The chemical analysis was performed by the project historical architect and by Ted Van Dyne, DSC lab aide, in accordance with test procedures developed at the North Atlantic Historic Preservation Center by E. Blaine Cliver and Norman R. Weiss. In addition to that procedure, samples M001 to M044 were tested for sulfate (SO_3) content in accordance with ASTM C114. The purpose of this test was to quantify gypsum content in plasters and to attempt to distinguish natural and Portland cements from lime mortars. The results of these tests are presented in the following tables.

A statistical analysis of the data was performed by Al Galipeau, statistician, Professional Support Division, Denver Service Center. The following table shows the test results. A discussion of analytical results on a sample-by-sample basis follows the statistical analysis.

1. Statistical Analysis

a. Data/Reliability of Quantitative Variables

Complete data are available on 46 of the samples, which were the only ones considered in the analysis.

Of the 46 samples, 13 were tested twice in the laboratory on three of the four quantitative variables (fines, sand, lime). All 13 were mortar samples. The first test results for each variable were tested against the set of second test results. Within all three variables the distributions were homogeneous, and there were no significant differences between the means. The conclusion is that the testing is internally consistent, and the data are reliable. Probable errors of the means were calculated. (Since these errors are for samples of 13, the errors of the means for all 24 of the mortar samples will be considerably less.) These errors, expressed in percent of the mean at a 90 percent confidence level, are as follows:

Fines	± 23.3 percent
Sand	± 8.9 percent
Lime	± 13 percent

b. Sampling Method

The data were not gathered equally for the different dates and types of material. This presented a problem because for the known dates most of the 1850 samples are mortar and most of the 1797 samples are plaster. Therefore, significant differences between mortar and plaster data confound the type and date variables. Statistical testing of differences between means and variances for mortar samples and plaster samples show that there is a significant difference between the means of sand, lime, and sulfates data and that the variances within lime and sulfate variables between mortar and plaster are heterogeneous. For

TABLE OF TEST RESULTS

SAMPLE NUMBER	LOCATION	PERCENT MASS RETAINED ON SIEVE SIZE											SAMPLE DATE	SAMPLE TYPE	HAIR?	TEST DATE	CONF. LINE	NOTES	
		4	5	16	30	50	100	200	Passd										
001	ROOM 001 FURNACE	2.02	2.05	17.71	.05	0	1.2	6.0	24.0	43.9	21.9	2.9	.15	1850	M	-	1850	MODERATE	
002	" " FLOOR	11.60	22.22	26.27	.52	0	4.6	4.8	13.9	38.6	30.0	6.8	1.2	1850	M	-	1850	HIGH	
003	W/007 BRICK SILL INFILL	14.79	25.26	26.71	.45	0	0	2.4	24.4	48.3	18.5	5.2	6.2	1850	M	-	1850	LOW	
004	ROOM 001 PARKING	4.40	18.72	62.42	.58	0	2.6	4.6	10.6	6.7	19.1	42.9	12.5	1797	C	-	1797	HIGH	
005	ROOM 001 S.WALL	13.79	74.80	25.17	.36	7.0	0.7	0.5	1.0	6.1	46.4	34.5	2.8	1797	M	-	1797	LOW	1
006	" " SMO. FLOOR	11.30	55.09	11.23	.15	19.1	6.7	9.7	21.2	28.0	11.1	3.4	0.8	1850	S	-	1850	MODERATE	
007	ROOM 002 S.WALL	20.74	34.40	21.38	.10	0	0.5	2.0	7.4	15.2	41.6	27.9	5.4	1797	C	-	1797	MODERATE	1
008	" " CEILING	11.59	47.40	22.79	.03	0	0	1.0	0.9	8.9	59.0	27.6	2.6	1797	P	-	1797	LOW	1
009	" " 003	6.52	21.77	24.76	1.57	0	0.6	0.4	2.5	16.7	52.4	23.8	3.6	1797	P	+	1797	VERY LOW	1
010	ROOM 003 INFILL @ DOOR	2.66	25.12	14.56	.02	2.3	10.5	14.3	19.8	28.5	19.4	4.8	0.4	POST 1797	M	+	1850	VERY HIGH	
011	" " CEILING @ S WALL	3.75	47.54	25.45	1.08	0	0.2	0.6	1.2	9.1	38.4	28.5	2.0	1797	C, P?	+	1797	LOW	1
012	ROOM 002 A N WALL	25.72	24.67	24.77	.55	0	0	1.2	2.7	7.0	34.4	41.0	12.9	1797	M	-	1797	MODERATE	
013	ROOM 004 FLOOR	10.91	62.58	28.15	.38	0	0.3	2.9	13.5	44.1	31.5	6.3	1.4	1850	M	-	1850	MODERATE	
014	ROOM 005 FLOOR @ W/019	7.52	47.11	32.34	.60	0	1.6	3.9	20.6	50.3	18.1	4.3	1.2	1850	M	-	1850	MODERATE	
015	" " BKT. SHELVING	7.11	18.26	21.23	.24	4.6	3.6	3.6	12.8	45.7	24.7	4.0	1.0	1850	M	-	1850	HIGH	
016	" " 011	7.20	52.57	21.31	.07	0	2.2	4.0	17.9	44.9	25.8	2.8	0.4	1850	M	-	1850	HIGH	
017	" " 004 BRICK CHIMNEY FDN.	22.28	28.20	21.45	.14	0	0.7	0.6	2.2	4.4	43.2	34.5	14.8	1797	M	-	1797	HIGH	
018	" " 006 W. WALL (STONE)	6.42	20.28	6.35	.20	6.5	11.6	16.5	20.4	14.7	18.4	7.1	0.4	1850	M	-	1850	HIGH	
019	" " BRICK OVEN	4.20	52.48	17.61	.00	0.3	8.4	12.2	21.7	34.7	19.9	2.5	0.3	1850	M	-	1850	VERY HIGH	
020	" " STONE OVEN FDN	5.37	51.48	19.20	.17	0	3.9	10.7	21.4	44.0	18.2	1.6	0.2	1850	M	-	1850	VERY HIGH	
021	" " BRICK OVEN INFILL	8.27	50.22	17.97	.17	0	0.8	2.3	8.9	38.4	41.2	7.6	0.8	POST 1850?	M	-	1840	LOW	
022	" " 001 STONE PIER	4.20	51.44	15.48	.03	2.3	6.7	9.2	21.1	36.4	19.9	2.6	0.3	1850	M	-	1850	HIGH	
023	" " 011 W. WALL (STONE)	4.02	49.19	18.68	.57	0	14.2	7.6	19.9	34.0	22.4	6.8	1.1	1850	M	-	1850	VERY HIGH	
024	" " 103 PATCH @ N.S. PTN.	8.07	72.09	27.11	.00	0	0	1.1	4.8	37.3	42.6	12.4	1.8	1840	P	+	1840	HIGH	
025	" " 004 BRICK SILL INFILL WOOD	1.27	52.74	18.74	.43	0	0	0.2	2.5	8.3	58.4	27.9	2.7	POST 1847?	M	-	1840	LOW	
026	" " INFILL WOOD	12.25	47.27	24.20	.04	0	0.9	2.9	16.4	53.9	20.5	4.7	0.7	POST 1850?	M	-	1850	LOW	
027	" " 101 @ D-20	14.18	34.17	24.64	.09	0	0	1.0	1.0	7.0	44.0	28.7	18.3	1797	M	-	1797	MODERATE	1
028	" " 108 PATCH @ N.S. PTN	1.71	47.27	24.85	.00	0	0	1.0	5.1	35.5	43.4	12.8	2.2	1840	P	+	1840	MODERATE	
029	" " N WALL W/ENL BRICK PATCH	28.77	20.49	52.97	.10	0	2.6	6.3	9.7	19.2	27.4	26.9	7.9	1340	B	+	1797	HIGH	2
030	" " "	14.84	46.22	27.20	1.00	0	0	0.4	0.9	9.0	44.6	22.8	2.3	1840	F	+	1840	MODERATE	
031	" " 105 ABOVE D-137	7.26	7.07	11.11	.20	0	0	0	1.1	1.1	2.2	4.5	1.1	1777	F	+	1777	HIGH	
032	" " 107 W/ENL ABOVE SHELF	44.29	14.43	10.71	.10	0	0.9	2.6	7.5	16.1	26.2	37.2	9.5	1777	P	+	1777	HIGH	
033	" " 006 BRICK OVEN INFILL	6.89	51.21	24.28	.12	0	0.5	2.6	7.4	36.3	42.5	9.6	1.1	POST 1850?	M	-	1840	MODERATE	
034	" " 203 E.WALL STAIR PATCH	25.10	22.07	12.27	.05	0	0	2.6	8.1	20.7	59.0	8.7	0.9	1850?	P (F?)	+	1840	MODERATE	
035	" " 203	42.21	14.61	18.22	.05	0	3.2	3.8	9.1	19.1	28.2	23.4	9.0	1797	B	+	1797	HIGH	
036	" " 205 ABOVE W.206	44.59	15.10	12.22	.17	0	0	2.8	7.2	18.5	30.8	31.8	8.9	1797	F	+	1797	HIGH	
037	" " 208	12.81	15.06	15.83	.49	0	3.2	2.5	3.9	10.0	18.5	31.7	30.2	1797	F	+	1797	HIGH	
038	" " 208 PATCH ALROUND WINDOW	17.75	44.82	78.71	1.22	0	0	0.6	7.0	35.0	33.9	18.5	2.0	POST 1850?	F	+	1840	VERY LOW	3
039	" " 112 CLOSET	2.71	8.22	78.71	.24	0	0	0	8.0	24.0	48.0	16.0	4.0	1850?	F	+	1840	LOW	
040	" " W WALL	6.31	5.25	11.42	.20	0	4.2	15.2	21.4	29.5	22.9	5.4	0.4	1850	P	+	1850	VERY HIGH	
041	" " 108 PATCH	2.70	4.30	11.00	1.00	0	0	0.5	8.8	51.4	31.1	7.7	2.5	POST 1850?	P	+	1850	VERY LOW	3
042	" " III	1	51.74	11.25	.10	0	6.3	4.7	18.9	30.4	24.2	5.0	0.5	1850	P	+	1850	HIGH	
043	" " 119 BRICK INFILL @ W/002	7.02	44.44	15.26	.14	0	6.5	10.1	17.1	26.8	28.9	9.5	1.1	1850?	M	+	1850	HIGH	
044	" " 112 CEILING	3.73	50.08	18.76	.26	0	5.7	11.6	17.3	25.8	25.3	3.8	0.5	1850	P	+	1850	VERY HIGH	
045	" " 119 BRICK INFILL @ W/002	15.10	44.61	28.24	.20	0	0	1.0	1.0	7.0	45.0	21.2	16.8	1797	M	-	1797	MODERATE	
046	" " 119 BRICK INFILL @ W/002	21.03	44.97	24.28	—	0	2.0	3.0	1.0	5.0	47.0	24.6	17.4	1797	B	+	1797	MODERATE	
047	" " 119 BRICK INFILL @ W/002	25.28	12.76	44.13	—	0	4.1	8.8	9.9	14.6	22.7	32.2	6.7	1797	B	+	1797	HIGH	
048	" " 119 BRICK INFILL @ W/002	24.28	22.07	27.12	—	0	1.2	1.4	2.4	2.9	24.6	52.7	14.8	1797	B	+	1797	VERY HIGH	
049	" " 119 BRICK INFILL @ W/002	10.24	48.82	17.52	—	0	1.1	0.8	6.8	28.5	42.5	17.7	2.6	1840	B	+	1840	MODERATE	
050	" " 119 BRICK INFILL @ W/002	11.57	47.32	19.28	—	0	0	1.2	6.9	30.6	43.6	15.9	1.9	POST 1840?	E	+	1840	MODERATE	
051	" " 119 BRICK INFILL @ W/002	12.45	45.80	20.49	—	0	0.4	0.9	8.1	40.1	38.8	10.0	1.7	1840	B	+	1840	MODERATE	
052	" " 119 BRICK INFILL @ W/002	44.27	11.02	15.44	—	0	1.0	7.4	9.4	18.4	29.7	27.8	6.3	1797?	B	+	1797	HIGH	
053	" " 119 BRICK INFILL @ W/002	7.23	44.14	49.24	—	0	0.9	0.7	3.6	28.7	43.7	10.8	1.6	POST 1850?	M	-	1840	MODERATE	
054	" " 119 BRICK INFILL @ W/002	27.10	17.67	47.10	.55	0	0.8	3.4	5.4	10.1	17.5	43.4	19.4	1797	E	+	1797	VERY HIGH	
055	" " 119 BRICK INFILL @ W/002	50.26	12.49	45.45	.10	0	2.6	3.0	4.1	9.7	19.7	27.6	24.3	1797	B	+	1797	VERY HIGH	
056	" " 119 BRICK INFILL @ W/002	4.27	52.42	12.67	.02	0	5.2	14.0	20.7	28.7	22.8	6.0	1.3	1850?	E	+	1850	VERY HIGH	

NOTES:

1 These samples (5, 7, 8, 9, 11, 27) are likely to belong to a different period. They are much more aligned with one another than with the 1797 group.

2 Sample 29 fits the 1797 pattern much better than that of the "Known" date of 1840.

3 These samples (38, 41) are very similar and do not match the pattern of any known sample date group.

Known	4	8	16	30	50	100	200	and			
1797 Mean	31.28	21.98	48.22	0	1.47	2.71	5.28	11.04	30.41	33.61	15.44
1840 Mean	14.49	20.26	25.46	0	.6	1.94	5.72	18.22	43.34	16.98	3.18
1850 Mean	6.17	30.55	18.23	1.24	6.22	10.11	19.4	37.26	21.87	4.17	.61

the qualitative data (hair, colors, grain size), significant differences were found between mortar and the plasters in three of the four cases. Because of the small number of samples of known date within mortar and plaster groups, some of the cluster analyses were done ignoring the known differences between mortar and the three plaster groups.

c. Cluster Analysis

Three cluster analyses were performed using a modification of Tryon's original technique. Each set of data for the four variables was first standardized within the variable. Each sample had a "profile" of four numbers, one from each of the standardized lists. Correlation coefficients between these four-number profiles were used to determine strength of relationship between variables and "seed" groups. Seed groups consisted of the average (arithmetic means) of scores of the members of the seed group within each variable.

d. "Unstructured" Clustering

In this analysis no underlying structure was assumed, and the data were allowed to cluster into "natural" groups. This analysis began with 15 clusters and was reiterated with decreasing numbers of clusters until no cluster had less than three members. This occurred at the seven-cluster level. This group was then further reduced until there were four natural clusters. For simplicity, only the hierarchy of the two groups (four clusters, seven clusters) is shown in the diagram. In the seven-cluster and four-cluster groups, clusters III and IV are the same. These two clusters remained unchanged throughout most of this analysis, indicating a strong independence. Clusters I and II of the four-cluster group are mixed with clusters A, B, C, D, and E of the seven-cluster group. These latter clusters are generally weaker than III and IV. Clusters III and IV contain seven out of the nine known samples from 1797 and all of the known samples from 1840. Unfortunately, the dates are just about equally distributed between the two clusters. Also, in these clusters, III is almost all plaster, and mortar and plaster are mixed equally in IV. All of the fine plaster samples are in these groups, and none of the mortar samples in these groups has a known date. Clusters I and II contain all the known 1850 samples.

e. Structured Clusters

Two structured cluster analyses were performed on the data. One used the average scores for each of the three known dates as cluster "seeds," the other used the known dates by type of plaster or mortar as "seeds." In the latter there were five seeds (therefore five clusters): three for 1797, mortar, base plaster, and finish plaster, and two for 1850, mortar and base plaster. There was too little data to include known 1840 samples in this analysis.

The three-year cluster analysis produced clusters with 11, 7, and 28 members for the years 1797, 1840, and 1850, respectively. For the 1797 group, only four of the nine known 1797 samples were found in the cluster; the other five were misclassified--two in the 1840 group and three in the 1850 group. Of the 23 samples of unknown date, eight had correlative coefficients with a dated cluster group above the median value of .9638, and 15 had a correlation coefficient above the mean of .8572. Of the 23 dated samples, all but six

UNSTRUCTURED CLUSTER ANALYSIS

	I	II	III	IV	
A	8	26	4	3	
	13		28	7	
	25		30	12	
	27		35	17	
			37	29	
B	2	1	38	31	
			10	40	32
			15	43	33
	16		19		36
	24				39
	42				
	44				
	45				
	46				
	C	5			
6					
18					
21					
41					
D		9			
		11			
		22			
E		14			
		20			
		23			
		24			

were correctly classified, and of these, two had very low (.36 and .32) coefficients and two were above the median value.

The year by type of material cluster analysis produced clusters ranging in size from 7 to 13 members. Nine of the undated samples had coefficients of above the median value of .9678, and 16 were above the mean value of .8690. Of the samples of known date, only one was misclassified by date and seven others were misclassified by mortar or plaster type. There were ten misclassifications of mortar or plaster type among the samples of unknown date.

A comparison of the three cluster analyses shows complete agreement on the dates of 11 of the samples with unknown dates. That is, if 1850 was the classified date (with an above the mean coefficient) for both structured analyses, the sample fell into cluster I or II; if the classified date was 1797, it fell into cluster III or IV. (No agreement was found on any 1840 dates.)

f. Qualitative Variables

The testing of mortar and plaster samples included the observation of four primarily qualitative variables: presence of hair, fines color, sand color, and sand grain size. A series of chi-square tests were made on the frequency counts of these variables occurring in the mortar and plaster types and in the dated samples. Highly significant findings between the plaster and mortar types indicate that plasters had hair and mortar did not, white fines color was found in finishing plaster, and finish plaster had more white sand and base plaster had more brown sand. There was no significant difference in the sand grain size of plaster and mortar types. None of these results is very surprising; however, the important point is that there was disproportionate sampling between types of mortar and plaster and known dates. Therefore, when the qualitative data were dated for patterns occurring at different known dates, the variables were confounded. Samples from 1850 were heavy in mortar; plaster predominated in the 1797 sample. However, since sand grain size was not found to be significantly disproportionate among mortar and plaster types, it can be used to differentiate years. Sand size was all coarse in 1850, and in 1797 it was 89 percent fine and the rest medium. Statistical tests of the frequency of sand grain size among the clusters produced in the unstructured cluster analyses showed significant differences in both the four- and the seven-cluster results. Using this as an additional variable to determine the date, six of the 11 undated samples for which there was complete agreement among the cluster analyses were in agreement on the sand grain size; only two were in disagreement, and the other three had medium sand grain size.

g. Conclusion of Statistical Analysis

It can be concluded that with equable sampling, the dependent variables used in this study have a very high capability of accurately indicating the year of samples of unknown date. We have very high confidence in the dating of six of the samples of unknown date, high confidence in the dating of five others, and some degree of confidence in most of the others.

2. Analytical Results

The following discussion of individual mortar and plaster samples is intended to relate the results of chemical, physical, and statistical analysis directly to the fabric of the building and to interpret the results into meaningful conclusions about the construction and evolution of the building. The samples are reproduced in appendix O.

Sample M001 is a mortar sample from the east wall of the brick furnace enclosure in room 001. To get a sample that was relatively unaffected by "rising damp," it was taken about 3' 6" above the floor. This sample was taken in the hope that it would provide additional information on the date of construction of the furnace. In the statistical analysis it was treated as an unknown. As a result of testing and statistical analysis, this sample was found to be most similar to sample M002, the mortar wash floor surface of room 001. This association confirmed the physical evidence of the floor surface being level with the ash cleanout for the furnace and therefore contemporary. Sample M001 is also similar to samples M006 and M022. Association with sample M006, soil from below the floor of room 001, is a bit surprising at first; but the fact that the sand used in the mortar is similar to that occurring naturally at the site and the possibility that lime from the floor may have leached into the soil below make it understandable. Sample M022 is mortar from the stone foundation of the tower exposed as a pier in the southeast corner of room 009--a known 1849 context. This association presents the possibility that the furnace enclosure was built in 1849-1850 and the present metal parts were installed later or are later replacements. This hypothesis seems very unlikely because construction of the furnace would be much simpler if the metal parts were installed first and the masonry enclosure was built around the firebox and ducts. A more likely hypothesis is simply that the similarity between the mortar used in the furnace enclosure and mortar floor finish and the mortar in the tower foundation is coincidental. Thus sample M001 is clearly associated by statistical analysis with the one sample that had already been associated with it by other means. But dating the sample proved impossible because of the lack of a comparable sample of known date.

Sample M002 was taken from the mortar wash finish floor of room 001. The purpose in taking this sample was to verify the relationship between this material and the furnace and to determine if this floor surface is related to the similar floor in room 004. This sample was treated as an unknown in the statistical analysis. That analysis confirmed its relation to the furnace mortar (sample M001) and indicated that there is not a close relationship between the floor finishes in rooms 001 and 004 (sample M013). The closest other correlations were with samples M022, 026, and 043--a known ca. 1850 context and two unknowns strongly correlated with ca. 1850 samples. That does not mean that the floor of room 001 was installed ca. 1850 (that is very unlikely for reasons discussed under sample M001). It simply means that there are strong similarities between the materials used ca. 1850 and those used within the next decade.

Sample M003 is mortar from the brick infill at the sill of window 007 on the north wall of room 001. This sample was taken in the hope that it would provide additional information on the date of alterations

to window 007. The sample was treated as an unknown in the statistical analysis. It correlated most closely with contextual associations to ca. 1850 construction. The statistical correlation of these samples to one another is very weak, however. The weakness of the correlation prevents the assignment of a date to this work.

Sample M004 is parging from the south wall of room 001. It was taken in an attempt to relate this area of parging to other finish surfaces. This sample was treated as an unknown in the statistical analysis. In the classification analysis, it is the unknown most highly correlated with known ca. 1797 samples. The cluster analysis associated it with samples M012, 031, and 037. Samples M031 and 037 were finish plaster from known ca. 1797 contexts. Sample M012 was an unknown mortar sample from the north wall of room 003A that was most closely associated with known ca. 1797 mortar and basecoat plaster. Thus the parging fits our expectation that it would relate both to plaster and mortar, and the consistent association with ca. 1797 samples is convincing evidence that the parging was applied as an original finish.

Sample M005 is mortar from the interior of the south wall of room 001. This sample was taken to determine if it would be possible to distinguish between the bedding mortar and the parging on 1797 work. In order not to bias this determination, the sample was treated as an unknown in the statistical analysis, even though it is from a known 1797 context. In the classification analysis, sample M005 correlates weakly with other 1797 samples. In the cluster analysis, it is most closely associated with samples M007, 009, and 011. Sample M007 is parging from the south wall of room 002. Thus, the similarity to 1797 parging is confirmed, but it is surprising that the statistical analysis does not indicate a strong similarity to sample M004, parging taken from a location less than 3' away from sample M005. Both, of course, are classified as of 1797 date, but the lack of a closer association points up the variations that can occur between different batches of mortar material within the same period of construction and the ability of the analysis to detect those differences.

Sample M006 is soil from under the floor of room 001. It was taken so that the soil from the site could be compared with the aggregates used in mortars and plasters. It was treated as an unknown in the statistical analysis. The classification analysis indicates that this sample correlates best with samples of a known 1850 date. This correlation suggests that the sand used in 1850 mortars and basecoat plasters came from the immediate vicinity or a very similar source. The individual samples that correlate most closely with M006 are M001, 002, 003, and 026. Samples M001 and 002 are associated with the ca. 1854 construction of the furnace. Sample M003 is mortar from the infilled sill of window 007--a probable 1850 context. Sample M026 is mortar from the brick infill of window 020--a convincing 1850 context.

Sample M007 is parging from the south wall of room 002. It was taken in an attempt to date the application of parging to basement walls. It was treated as an unknown in the statistical analysis. The classification analysis indicates a probable date of 1797, but the confidence level of this date is not high. The individual samples most

closely correlated with M007 are M005, 009, and 027. Sample M005 is bedding mortar from the south wall of room 001--a known 1797 context. Sample M009 is ceiling plaster from Room 003--a context which seems to post-date the furnace installation. Sample M027 is mortar from the 1797 masonry around door 120. In the classification analysis, all of these samples have been confidence ratings for their association with 1797 work. Sample M009 is an anomaly. As a post-1850 basement ceiling plaster, it is coarser than other plasters and its similarity to 1797 parging and mortars, which have finer aggregates than other mortars, is understandable.

Sample M008 is ceiling plaster from room 002. It was taken to determine if the ceiling plasters in rooms 002 and 003 were related to one another chemically and physically as well as visually and contextually. In the statistical analysis it was treated as an unknown. It was incorrectly and with low confidence assigned a 1797 date by the classification analysis. The samples that correlated best were M009 and 011. Both are ceiling plaster from different parts of room 003. Thus, the relatedness of basement ceiling plasters is confirmed.

Sample M009 is ceiling plaster from room 003. It was taken to determine the relatedness of basement ceiling plasters and was treated as an unknown in the statistical analysis. It was incorrectly assigned a 1797 date in the classification analysis, but the cluster analysis grouped it with samples M005, 007, 008, and 011. Samples M005 and 007 are 1797 bedding mortar and parging respectively, but the association with them is understandable in light of the fact that they contain finer than usual aggregates for mortar and sample M009 contains coarser than usual aggregates for a plaster. As expected, sample M009 correlated well with samples M008 and 011--the other basement ceiling plaster samples.

Sample M010 is mortar from the masonry infill around door 006 on the west wall of room 003. It was taken in an attempt to assign a date to this alteration and was treated as an unknown in the statistical analysis. The classification analysis assigned it a date of 1850 with high confidence. The samples most closely correlated with M010 are M020, M023, M044, and M056. The first three are from known 1850 contexts, and M056 was confirmed as an 1850 context by this analysis. Samples M020 and M023 are mortars, and M044 and M056 are plasters.

Sample M011 is ceiling plaster from Room 003. It was taken to determine the relatedness of basement ceiling plasters and was treated as an unknown in the statistical analysis. It was incorrectly and with low confidence assigned a date of 1850 in the classification analysis, but the cluster analysis grouped it with samples M005, 008, and 009. Samples M008 and 009 are ceiling plasters from rooms 002 and 003 respectively. Sample M005 is bedding mortar from the south wall of room 001. The similarity of plasters to mortar is explained above.

Sample M012 is mortar from the brick wall on the north side of room 003A. Because this is the only brick wall in the 1797 portion of the basement and it is veneer over a stone wall, this sample was taken to determine if the wall was original or a later alteration. The sample was treated as an unknown in the statistical analysis. The classification

analysis assigned it a date of 1797 with a moderately high level of confidence. It correlates best with samples M004, 017, and 055. Sample M004 is parging from the south wall of room 001. This analysis assigned it a date of 1797 with a high degree of confidence. Sample M017 is mortar from the brick chimney foundation in room 004--a known 1797 context. Sample M055 is basement plaster from the wall of room 205 above window 206--a known 1797 context. This brick veneer appears to have been part of the original 1797 construction.

Sample M013 is mortar from the floor of room 004. It was taken as part of an effort to relate basement floors to one another and was treated as an unknown in the statistical analysis. The classification analysis assigned it a date of 1850 with a moderate degree of confidence. The cluster analysis grouped it most closely with samples M015 and 016. They are floor mortar samples from infill between sleepers in rooms 005 and 011 respectively. It does not correlate closely with sample M001, floor mortar from room 001, which tends to confirm the conclusion that the furnace and floor surface post-date 1850.

Sample M014 is floor mortar from behind the window paneling in room 005. This sample was taken to confirm the date of alterations to room 005 and was treated as a known 1850 sample in the statistical analysis. The classification analysis confirmed its 1850 date with moderate confidence. Samples M022 and 026 were most closely related in the cluster analysis. Sample M022 is mortar from the stone pier in the southeast corner of room 009. Sample M026 is mortar from the brick infill of window 020. Both of these are firm 1850 contexts.

Sample M015 is mortar from between the sleepers in the floor of room 005. It was tested to determine the relatedness of basement floors and was treated as a known 1850 sample in the statistical analysis. The classification analysis confirmed the 1850 date with a high level of confidence. The cluster analysis grouped it most closely with samples M013 and M016. Both are floor mortars, M013 from the mortar wash floor of room 004 and M016 from between the sleepers in room 011.

Sample M016 is floor mortar from between the sleepers in room 011. It was tested to determine the relatedness of basement floors and was treated as a known sample in the statistical analysis. The classification analysis confirmed the 1850 date with a high level of confidence. The cluster analysis associated it most closely with samples M015 and M043. Sample M015 is mortar from between the sleepers in room 005. Sample M043 is mortar from the brick infill of D105. Both contexts have been solidly dated to 1850.

Sample M017 is mortar from the brick chimney foundation in room 004. It was tested to provide baseline data for 1797 brick mortar and was treated as a known 1797 sample in the statistical analysis. The classification analysis confirmed the 1797 date with a high level of confidence. The cluster analysis grouped it with samples M012, 046, and 054. Sample M012 is mortar from the north wall of room 003A. Sample M046 is mortar from exterior stonework between windows 001 and 002. Sample M054 is basecoat plaster from the south wall of room 102, above door 137. Both samples M046 and 054 are known 1797 samples. Sample

M012 was treated as an unknown, but this analysis has concluded that it also dates to 1797.

Sample M018 is mortar from stonework in the west wall of Room 006. It was tested to provide baseline data for 1850 stonework mortar and was treated as a known in the statistical analysis. The classification analysis confirmed the 1850 date with a high level of confidence. The cluster analysis associated it with samples M020, 040, 042, 044, and 056. Sample M020 is mortar from the stone foundation of the oven in room 006--a known 1850 context. Samples M040, 042, 044, and 056 are all 1850 plaster samples. All the related samples are also dated to 1850 with a high level of confidence.

Sample M019 is mortar from the brick oven in room 006. It was tested to provide baseline data for 1850 brickwork mortar and was treated as a known in the statistical analysis. The classification analysis confirmed the 1850 date with a very high level of confidence. The cluster analysis grouped it with samples M023 and 044. Sample M023 is mortar from the stonework on the west wall of room 011; sample M044 is plaster from the ceiling of room 112. They are both known 1850 samples.

Sample M020 is mortar from the stone foundation of the oven in room 006. It was tested to establish baseline data for 1850 stonework mortar and was treated as a known in the statistical analysis. The classification analysis confirmed the 1850 date with a very high level of confidence. The cluster analysis associated samples M010, 018, and 040 with it. Sample M010 is mortar from the infill at door 006. It has been dated to 1850 with a high level of confidence. Sample M018 is mortar from stonework on the west wall of room 006. It is a known 1850 sample. Sample M040 is plaster from the west wall of room 112--a known 1850 context.

Sample M021 is mortar from the brick infill of the former oven door opening in room 006. It was tested in an effort to determine the date of abandonment of the brick oven. Therefore, it was treated as an unknown in the statistical analysis, but by its context we know it post-dates 1850. In the classification analysis it was incorrectly and with low confidence assigned a date of 1840. The cluster analysis grouped it with samples M024, 025, 049, 051, and 053. Sample M024 is plaster from a patch on the north wall of room 108. It was treated as a known 1840 sample in the statistical analysis. Sample M025 is mortar from the infill at the sill of window 002. It was treated as an unknown in the statistical analysis and assigned a date of 1840 with low confidence by the classification analysis. Sample M049 is basecoat plaster from the south end of the west wall of room 208. Based on the discussion in section IV.B.3., this area is considered to date to ca. 1810. The classification analysis assigned it a date of 1840 with low confidence. This is understandable because that analysis only allows three options--1797, 1840, or 1850. It simply was more similar to the known 1840 samples than to the known 1797 or 1850 samples. Sample M051 is a basecoat plaster from the infill of the chair rail in room 208. It was treated as a known 1840 sample in the statistical analysis. Sample M053 is mortar from the brick infill of the fireplace in room 114. It was treated as an unknown in the statistical analysis, but by its context we know it post-dates 1850.

The problem with attempting to date sample M021 is that we do not have an appropriate sample of known data with which to compare it. The statistical analysis clearly indicates that it does not fit well with any of the known samples and thereby confirms the contextual evidence that it post-dates 1850. Its closest correlation is with sample M053, which is also known to post-date 1850.

Sample M022 is mortar from the stone pier in the southeast corner of room 009. It was initially tested to determine if the tower foundation might be a surviving part of an earlier structure on the site. When that analysis showed a strong correlation with known 1850 mortars, that hypothesis was rejected and it was treated as a known 1850 sample in the final statistical analysis. The classification analysis confirmed its 1850 date with a high level of confidence. The cluster analysis grouped it with samples M001, 002, 014, and 042. Sample M001 and 002 are both post-1850 mortars that bear a strong resemblance to known 1850 mortars. Samples M014 and 042 are known 1850 mortars.

Sample M023 is mortar from stonework in the west wall of room 011. It was tested to provide baseline data on 1850 mortars and was treated as a known 1850 sample in the statistical analysis. The classification analysis confirmed the 1850 date with a very high level of confidence. The cluster analysis grouped it with samples M010, 019, 044, and 056. Samples M019 and 044 are known 1850 samples. Samples M010 and 056 are unknown; both of them correlated very highly with 1850 samples.

Sample M024 is plaster from a patch in the north wall of room 108. The patch is considered to date to 1840 on the basis of contextual evidence discussed in section IV.B.2. It was treated as a known 1840 sample in the statistical analysis. The classification analysis confirmed the 1840 date with a high level of confidence. The cluster analysis grouped it with samples M021, 049, and 053. Samples M021 and 053 are post-1850 mortars used in brick infill. Sample M049 is basecoat plaster from the west wall of room 208--a ca. 1810 context. With all 1840 known or statistically classified samples there will be problems because only four known 1840 samples were tested and only samples M028 and 051 correlated closely with one another.

Sample M025 is mortar from the infilled sill area of window 002 in room 004. It was tested in an effort to associate it with samples of known dates. It was treated as an unknown in the statistical analysis. The classification analysis assigned a date of 1840 with low confidence. The cluster analysis grouped it with samples M017, 030, and 041. Sample M017 is a known 1797 sample, sample M030 is a known 1840 sample, and sample M041 is a post-1850 sample that was mistakenly classified as 1840.

Sample M026 is mortar from the brick infill of window 020 in room 004. It was tested in an attempt to determine the date of the infill. Contextual evidence suggests a date of 1850 or before. It was tested as an unknown in the statistical analysis. The classification analysis assigned it an 1850 date with low confidence. The cluster analysis grouped it with samples M002, 003, 006, and 014. Sample M002 is known to date after 1853. Sample M003 was assigned a date of 1850

with low confidence by the statistical analysis, but contextual evidence tends to raise our confidence in that date. Sample M006 is a soil sample, and sample M014 is a known 1850 sample. In view of the 1850 construction on the west side of the window, the 1850 date is probably correct.

Sample M027 is mortar from the known 1797 brick masonry around door 120. It was tested to establish baseline data for 1797 mortars. It was treated as a known 1797 sample in the statistical analysis. The classification analysis confirmed the 1797 date but with only moderate confidence. The cluster analysis grouped it with samples M007, 038, and 046. Sample M007 is known 1797 parging. Sample M038 is plaster from a patch around the stovepipe opening in room 208. Sample M046 is known 1797 mortar from the stone foundation between windows 001 and 002.

Sample M028 is plaster from a patch in the north wall of room 108 and was tested to establish baseline data for 1840 plasters and was treated as a known 1840 sample in the statistical analysis. The classification analysis confirmed the 1840 date with moderate confidence. The cluster analysis grouped it with samples M034 and 051. Sample M034 is plaster from the patch of a stair stringer on the east wall of room 203. This context strongly suggests a date of 1850, as discussed in section IV.B.3. However, the classification analysis assigned it a date of 1840 with a moderate level of confidence. Sample M051 is basecoat plaster from chair rail infill in room 208. This is a known 1840 context.

Sample M029 is a basecoat plaster from a patch in the west end of the baseboard on the north wall of room 108. It was treated as a known 1840 sample in the statistical analysis, but the classification analysis assigned it a date of 1797 with high confidence. The cluster analysis grouped it with samples M035, 036, and 047. All three are known 1797 samples that were confirmed with a high level of confidence by the classification analysis. This result calls for reconsideration of our initial judgment. On reexamination of this and other 1797 baseboard locations, it was noted that baseboards were applied over the basecoat plaster. Thus, the investigated patched area only consisted of the top layers of plaster, and the basecoat is indeed 1797 material.

Sample M030 is finish coat plaster from the same area as sample M029. It was treated as a known 1840 sample in the statistical analysis. The classification analysis confirmed the 1840 date with moderate confidence. The cluster analysis grouped it with samples M025 and 051. Sample M025 is an unknown window infill sample that was classified as 1840. Sample M051 is a known 1840 sample.

Sample M031 is finish plaster from room 102. It was tested to provide baseline data for 1797 plasters and was treated as a known 1797 sample in the statistical analysis. The classification analysis confirmed the 1797 date with high confidence. The cluster analysis grouped it with samples M004, 037, and 047. Sample M004 is parging from room 001, which was classified as 1797. Samples M037 and 047 are known 1797 plasters--finish coat and baseboard, respectively.

Sample M032 is plaster from the west wall of room 107 above the shelf. It was tested to establish baseline data for 1797 plasters. It was tested as a known 1797 sample in the statistical analysis. The classification analysis confirmed the 1797 date with high confidence. The cluster analysis grouped it with samples M035, 036, and 052. Samples M035 and 036 are known 1797 plaster samples--basecoat and finish, respectively. Sample M052 is basecoat plaster from the north wall of room 208, which was considered to be a 1797 context, but the sample was treated as an unknown to test the classification analysis. It was properly assigned a 1797 date.

Sample M033 is mortar from the brick infill of the door in the oven in room 006. It was tested in an effort to date the abandonment of the oven and to evaluate the mortar testing program. It was treated as an unknown in the statistical analysis. The classification analysis erroneously assigned it a date of 1840 with moderate confidence. The cluster analysis grouped it with samples M030, 049, and 050. Sample M030 is a known 1840 sample. Samples M049 and 050 probably date to ca. 1810. None of these dates is possible for sample M033 because the structure being infilled was built in 1849-1850. Sample M021 was taken from the same location as sample M033, but the analysis did not reveal a very close relationship between them. They were grouped together, but other samples were more similar.

Sample M034 is infill plaster from the patch of a stair stringer along the west wall of room 203. It was tested to confirm the 1850 date of this work suggested by contextual evidence discussed in section IV.B. It was treated as an unknown in the statistical analysis. The classification analysis assigned it a date of 1840 with a moderate level of confidence. The cluster analysis associated it with samples M013, 024, 028, and 051. Sample M013 is a mortar sample from the floor of room 004, which was assigned a date of 1850. Sample M024 is plaster from a patch in the north wall of room 108, which was treated as a known 1840 context because the stair above was installed in 1840; however, it is conceivable that the scar from the removal of the partition from this area was not patched until 1850. Sample M028 is from the same context as sample M024. Sample M051 is basecoat plaster from a chair rail patch in room 208. Sample M051 was treated as a known 1840 sample, but as a basecoat plaster, it may have been applied in 1797 prior to the chair rail installation. For all the above reasons, the results of chemical and statistical analysis for sample M034 must be rejected, and the contextual evidence of an 1850 date for removal of this stair accepted.

Sample M035 is basecoat plaster from the east wall of room 203. It was tested to provide baseline data for 1797 basecoat plasters and was treated as a known 1797 sample in the statistical analysis. The classification analysis confirmed the 1797 date with high confidence. The cluster analysis grouped it with samples M029, 032, 036, and 052. All these samples are 1797 plasters.

Sample M036 is finish coat plaster from room 203. It was tested to provide baseline data for 1797 plasters and was treated as a known 1797 sample in the statistical analysis. The classification analysis confirmed the 1797 date with high confidence. The cluster analysis

grouped it with samples M029, 032, 035, and 052. All these samples are 1797 plasters.

Sample M037 is finish coat plaster from the east wall of room 205 above window 206. It was taken to provide baseline data on 1797 plasters and was treated as a known 1797 sample in the statistical analysis. The classification analysis confirmed its 1797 date with high confidence. The cluster analysis grouped it with samples M031 and 045. Sample M031 is known 1797 finish coat plaster and sample M045 is known 1797 mortar for brickwork.

Sample M038 is plaster from a patch around the stovepipe opening between rooms 208 and 205. Contextual evidence recorded at the time of sampling indicates that the plaster was applied to seal around the stovepipe at the time of its installation. It was tested in an attempt to determine the date of this installation and was treated as an unknown in the statistical analysis. The classification analysis assigned it a date of 1797 with very low confidence, which seems like an extremely improbable conclusion because it is a patch in surrounding 1797 material. The cluster analysis grouped it with samples M027 and 041. Sample M027 is a known 1797 mortar and sample M041 is a known post-1850 plaster patch in the ceiling of room 112.

Sample M039 is finish coat plaster from the closets that opened into room 112. It was tested in an attempt to determine the date of original construction of this abandoned space and was treated as an unknown in the statistical analysis. The classification analysis erroneously assigned it a date of 1840 with low confidence. This is clearly impossible because the part of the building in which it was found was not built until 1849-1850. The cluster analysis grouped it with samples M025, 031, 036, and 047. Sample M025 is infill mortar from window 002, which was assigned a date of 1840 with low confidence. Samples M031 and 036 are known 1797 finish plasters; sample M047 is a known 1797 basecoat plaster. The results of chemical and statistical analysis of this sample have been rejected as inconsistent with the known context of the sample.

Sample M040 is plaster from the west wall of room 112. It was tested to provide baseline data for 1850 plasters and was treated as a known 1850 sample in the statistical analysis. The classification analysis confirmed its 1850 date with very high confidence. The cluster analysis grouped it with samples M018, 020, and 056. Samples M018 and 020 are from known 1850 stonework. Sample M056 is basecoat plaster from the closet adjoining room 112.

Sample M041 is plaster from a patch in the ceiling of room 112. It was tested in an attempt to determine the date of the patch and was treated as an unknown in the statistical analysis. The classification analysis erroneously assigned it a date of 1840 with very low confidence. The cluster analysis grouped it with samples M018, 022, and 043. Samples M018 and 022 are known 1850 mortars from stonework. Sample M043 was determined to be an 1850 brick mortar.

Sample M043 is mortar from the brick infill of door 105. The context strongly suggests an 1850 date. The sample was tested to

confirm the contextual evidence and treated as an unknown in the statistical analysis. The classification analysis confirmed the 1850 date with high confidence.

Sample M044 is plaster from the ceiling of room 112. It was tested to provide baseline data for 1850 plasters and was treated as a known 1850 sample in the statistical analysis. The classification analysis confirmed the 1850 date with the highest confidence of any sample.

Sample M045 is mortar from exterior brickwork above window 001. It was tested to provide baseline data for 1797 mortars and was treated as a known 1797 sample in the statistical analysis. The classification analysis confirmed the 1797 date with high confidence.

Sample M046 is mortar from exterior stonework between windows 001 and 002. It was tested to provide baseline data for 1797 mortars and was treated as a known 1797 sample in the statistical analysis. The classification analysis confirmed the 1797 date with moderate confidence. The cluster analysis grouped it with samples M017 and 045. Both are known 1797 mortar samples.

Sample M047 is basecoat plaster from the south end of the east wall of room 210. It was tested to provide baseline data for 1797 plasters and was treated as a known 1797 sample in the statistical analysis. The classification analysis confirmed the 1797 date with high confidence.

Sample M048 is basecoat plaster from the south jamb of door 216 in room 210. This is an area of infill applied when door 216 was moved to the north. Based on the use of split lath and crude machine-made nails, this change has been associated with the ca. 1810 changes thought to have been made by William P. Van Ness. This sample was tested to determine if there is also a similarity between the plasters used in these areas. It was tested as an unknown in the statistical analysis. The classification analysis assigned it a date of 1797 with very high confidence. The cluster analysis grouped it with samples M054 and 055. Both are known 1797 basecoat plasters. The chemical, physical, and statistical analysis does not confirm the contextual evidence.

Sample M049 is basecoat plaster from the south end of the west wall of room 208. As discussed in section IV.B.3., this is considered a ca. 1810 context. This sample was tested in an attempt to associate it with similar samples. It was treated as an unknown in the statistical analysis. The classification analysis assigned it a date of 1840 with moderate confidence. The cluster analysis grouped it with samples M021, 024, 033, and 053. Samples M021 and 033 are post-1850 samples from the infill of the brick oven in room 006. Sample M053 is post-1850 infill of the fireplace in room 114. Sample M024 is plaster from a patch in the north wall of Room 108, which is considered an 1840 context. The chemical, physical, and statistical analysis did not associate samples M048, 049, and 050 with one another as expected.

Sample M050 is basecoat plaster from the infill of door 219 on the north wall of room 208, which is considered to be a ca. 1810

context. It was tested in an attempt to associate it with similar samples and was treated as an unknown in the statistical analysis. The classification analysis assigned it a date of 1840 with moderate confidence. The cluster analysis grouped it with samples M033 and 053; both are post-1850 infill mortars. It was not found to be closely associated with samples M048 and 049 as expected.

Sample M051 is basecoat plaster from the infill of the chair rail in room 208. On the basis of evidence presented in section IV.B.2., this is considered an 1840 context. It was tested to provide baseline data for 1840 plasters and was treated as a known 1840 sample in the statistical analysis. The classification analysis confirmed the 1840 date with moderate confidence. The cluster analysis grouped it with samples M028 and 030, which are known 1840 plaster.

Sample M052 is basecoat plaster from the north wall of room 208. This is considered a 1797 context, but the multitude of changes that have occurred in this room led it to be treated as an unknown in the statistical analysis. The classification analysis confirmed the 1797 date with high confidence.

Sample M053 is mortar from the brick infill of the fireplace in room 114, which is known to post-date 1850. It was tested in an attempt to associate it with similar samples and treated as an unknown in the statistical analysis. The classification analysis erroneously assigned it a date of 1840 with moderate confidence. This is understandable because there were no known samples of post-1850 date with which to compare it. The cluster analysis grouped it with samples M021, 049, and 050. Sample M021 is infill mortar from a similar post-1850 context. Samples M049 and 050 are considered to be from ca. 1810 contexts.

Sample M054 is basecoat plaster from the south wall of room 102 above door 137. It was tested to provide baseline data for 1797 plasters and was treated as a known 1797 sample in the statistical analysis. The classification analysis confirmed the 1797 date with very high confidence.

Sample M055 is basecoat plaster from room 205 above window 206. It was tested to provide baseline data for 1797 plaster and was treated as a known 1797 sample in the statistical analysis. The classification analysis confirmed the 1797 date with very high confidence.

Sample M056 is basecoat plaster from the closet adjoining room 112. It was tested in an attempt to determine the date of construction of this abandoned space and was treated as an unknown in the statistical analysis. The classification analysis assigned it a date of 1850 with very high confidence.

3. Conclusion

This is the first time statistical analysis techniques have been applied to the results of chemical and physical analyses of mortar and plaster samples from historic buildings. The application has succeeded in making objective and thorough comparisons of a large number of samples. Statistical analysis has identified unexpected

similarities and dissimilarities between samples. These results could never have been achieved by other techniques.

As a first attempt, it is subject to many of the shortcomings that characterize first attempts. With the benefit of hindsight, it is clear that the research design would have been improved by collecting more samples of known dates. With a sufficient number of samples from ca. 1810, ca. 1840, and post-1850 contexts, we could have avoided the erroneous classification of many samples as 1840. This occurred because 1840 was the only alternative for classifying samples that did not fit neatly into 1797 or 1850 groups. It would also have been useful to have known categories for types of samples, such as mortar, basecoat plaster, finish plaster, or parging.

There are also questions that arise concerning the adequacy of the chemical and physical tests that were performed. An article published recently in the Bulletin of the Association for Preservation Technology states that the analytical technique developed by E. Blaine Cliver (and used for this report) produces unreliable results (Stewart and Moore 1982, vol. 14, no. 1:11-16). However, the statistical analysis of duplicate tests indicates that the test results are internally consistent, so use of the tests for internal comparisons is valid. We did not address the question of which of the many factors we compared were most significant. The fact that only three factors related to overall composition and eight factors related to sand composition were studied may have made the sand a disproportionately significant factor and may have obscured the ability of the tests to distinguish between mortars and plasters. On the other hand, sand is probably more consistent within one building campaign than proportions of sand to lime or cement, which vary from batch to batch.

BIBLIOGRAPHY

- Bancroft, G. Martin Van Buren: To the End of His Public Career. New York, 1889.
- Booth, E.T. "Martin Van Buren at Lindenwald." In Country Life in America as Lived by Ten Presidents of the United States. New York: A.A. Knopf, 1947.
- Blair, Francis P. Family Papers. Library of Congress, Washington, D.C.
- Brown, Glenn. The Water Closet. London, 1884.
- Butler, W.A. Martin Van Buren. New York, 1862.
- The Builder
- Collier, Edward A. A History of Old Kinderhook. New York, 1914.
- Doggett's New York Directory
- Downing, A.J. The Architecture of Country Houses. New York: D. Appleton & Co., 1850.
- Downs, Joseph. Papers. Manuscript and Microfilm Collection, Henry Francis DuPont Winterthur Museum.
- Edgerton, Charles E. "The Wire-Nail Association of 1895-96." Political Science Quarterly 12, no. 2:246-47.
- Fleming, John, Hugh Honour, and Nikolaus Pevsner, eds. Penguin Dictionary of Architecture. 3rd ed. New York: Penguin Books, 1980.
- Fontana, Bernard L., J. Cameron Greenleaf, et al. "Johnny Ward's Ranch: A Study in Historic Archeology." The Kiva 28 (October-December 1962):48.
- Gerhardt, Tom H. "Old House Intercoms: Buzzers, Beepers, Buttons, & Bells." Old House Journal 7 (October 1979):112-15.
- Gettens, Rutherford J., and George L. Stout. Painting Materials. New York: Dover Publications, 1966.
- Gilpin, Henry D. Papers. Poinsett Section, Pennsylvania Historical Society.
- Girouard, Mark. Life in the English Country House: A Social and Architectural History. New Haven: Yale University Press, 1978.

- _____. The Victorian Country House. New Haven: Yale University Press, 1979.
- Hardenbrook, Louise. "Letter to Martin Van Buren." Columbia County Historical Society Bulletin, 1938.
- Harris, Cyril M., ed. Dictionary of Architecture and Construction. New York: McGraw-Hill Book Co., 1975.
- Hellyer, S. Stevens. The Plumber and Sanitary Houses. London, 1877.
- Hennessy, Thomas, F. Early Locks and Lockmakers of America. Des Plaines, IL: Nickerson and Collins Publishing Co., 1976.
- Hussey, E.C. Victorian Homebuilding--A Transcontinental View of 1875. Reprint ed. Watkins Glen: American Life Foundation, 1976.
- Illustrated Catalogue of American Hardware of the Russell and Erwin Manufacturing Company, 1865. Reprint ed. Baltimore: Association for Preservation Technology, 1980.
- Jenkins, J.S. Lives of Governors of New York. Auburn, NY, 1851.
- Lynch, Denis Tilden. An Epoch and a Man: Martin Van Buren and His Times. New York: H. Liveright, 1929.
- McKee, Harley J. Introduction to Early American Masonry: Stone, Brick, Mortar and Plaster. Washington: National Trust for Historic Preservation and Columbia University, 1973.
- MacKenzie, William L. The Life and Times of Martin Van Buren. Boston: Cooke and Co., 1846.
- Martin Asa E. "The Little Magician at Lindenwald." In After the White House, State College, PA: Penns Valley Publishers, 1951.
- Metals in America's Historic Buildings. Washington: U.S. Department of the Interior, Heritage Conservation and Recreation Service, 1980.
- Meleyard, Eliza. The Wedgewood Handbook. London: Bell, 1875.
- National Park Service, U.S. Department of the Interior. "Historic Resource Study, Lindenwald, Martin Van Buren National Historic Site," by John D.R. Platt. Denver, 1982. On file at Denver Service Center.
- _____. "Historic Structure Report, Archeological Data Section, Martin Van Buren, Lindenwald," by Kathleen W. Fiero. Denver, 1983. On file at the Denver Service Center.
- _____. "Lindenwald, The President Martin Van Buren Homestead, Near Kinderhook, New York," by Melvin J. Weig. 1936. On file at Martin Van Buren National Historic Site.

- _____. "Management Policies." Washington, 1980.
- Nelson, Lee H. Nail Chronology as an Aid to Dating Old Buildings. Technical leaflet 48. Nashville, TN: American Association for State and Local History, 1968.
- Peterson, Charles E., ed. Building Early America: Contributions toward the History of a Great Industry.
- _____. The Carpenters' Company of the City and County of Philadelphia 1786 Rule Book. Princeton, Pyne Press: 1971.
- Richardson, James D. A Compilation of the Messages and Papers of the Presidents, 1889-1908. Vol. 3. Washington: Bureau of National Literature and Art, 1909.
- Savage, George, and Harold Newman. An Illustrated Dictionary of Ceramics. New York: Van Nostrand Reinhold Company, 1975.
- Shepard, E.M. Martin Van Buren. Boston: Houghton Mifflin, 1899.
- Simon, Brona G. "Historic Grounds Report, Lindenwalk, Martin Van Buren National Historic Site, Kinderhook, New York." Vol. 2, "Archeological Section." Prepared for the National Park Service. Public Archaeology Laboratory, Brown University, 1981.
- Sonn, Albert H. Early American Wrought Iron. New York: Charles Scribner's Sons, 1928.
- Stewart, John, and James Moore. "Chemical Techniques of Historic Mortar Analysis." Bulletin of the Association for Preservation Technology 14, no. 1 (1982):11-16.
- Stokinger, William A. "Historic Ground Report, Lindenwald, Martin Van Buren National Historic Site, Kinderhook, New York." Vol. 1, "Documentary Section." Prepared for the National Park Service. Public Archaeology Laboratory, Brown University, 1981.
- Stone, May N. "The Plumbing Paradox." Winterthur Portfolio 14 (Autumn 1979):283-309.
- Streeter, Donald. "Early American Wrought Iron Hardware, English Iron Rim Locks: Late 18th and Early 19th Century Forms." Bulletin of the Association for Preservation Technology 6, no. 1:41-67.
- _____. "Some Signed American Iron Rim Locks." Bulletin of the Association for Preservation Technology 5, no. 2 (1973).
- Stull Associates, Inc., and R.G. Vanderweil Engineers, Inc. "Commanding Officer's House Historic Heating System, Springfield Armory National Historic Site." Prepared for the National Park Service, 1979. On file at Springfield Armory National Historic Site.

- Teale, T.P. Dangers to Health. London: Churchill, 1878.
- Throop and Martin. Family Papers. Princeton University, Princeton, NJ.
- Timmons, Sharon, ed. Preservation and Conservation: Principles and Practices. Washington: National Trust for Historic Preservation, 1976.
- Traveler's Notebook 1810. Wedgwood Museum, Barlaston, Stoke-on-Trent, England.
- Trump, Robert Townshend. "The Carpenter-Type Lock." Antiques 66, no. 6 (1954).
- Upjohn, Everand M. Richard Upjohn, Architect and Churchman. New York: Columbia University Press, 1939.
- Upjohn, Richard, and Company. Planbook, 1846-54. Avery Library, Columbia University, New York.
- Unpublished manuscript record of disposition of drawings from the architect's office.
- Upjohn, Richard and Richard M. Papers. New York Public Library.
- Van Buren, Angelica Singleton. Papers. Library of Congress, Washington.
- Van Buren, Martin. "Autobiography." Edited by John C. Fitzpatrick. In American Historical Association, Annual Report 1918, vol. 2.
- _____. Last Will and Testament. Columbia County Surrogate's Office, New York.
- _____. Papers. Columbia County Historical Society.
- _____. Papers. Library of Congress, Washington.
- Van Buren, Martin, and George Bancroft. Correspondence 1830-45. Massachusetts Historical Society Proceedings, vol. 2, 1909.
- Van Ness, Peter. Will. Columbia County Historical Society.
- Van Ness, William P. Papers. New York Historical Society.
- "A Visit to Kinderhook." New York History 35 (1954).
- Waite, Diana S. Nineteenth Century Tin Roofing and Its Use at Hyde Hall. Albany: New York State Historic Trust, 1971.
- Welles, Gideon. Papers. Library of Congress, Washington.
- Wedgwood Shape Book 1803. Barlaston, England: Wedgwood Museum.
- Wright, Lawrence. Clean and Decent. New York: Viking Press, 1960.

As the nation's principal conservation agency, the Department of the Interior has basic responsibilities to protect and conserve our land and water, energy and minerals, fish and wildlife, parks and recreation areas, and to ensure the wise use of all these resources. The department also has major responsibility for American Indian reservation communities and for people who live in island territories under U.S. administration.

Publication services were provided by the graphics staff of the Denver Service Center. NPS D-8